

TOSHIBA

SERVICE MANUAL

AIR-CONDITIONER

SPLIT TYPE

Indoor Unit

RAS-18N3KV-E
RAS-22N3KV-E

Outdoor Unit

RAS-18N3AV-E
RAS-22N3AV-E

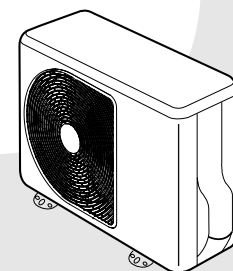
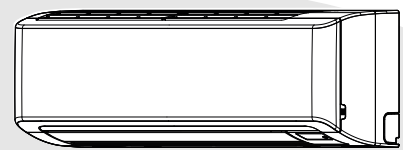

CONTENTS

1. SAFETY PRECAUTIONS	2
2. SPECIFICATIONS	5
3. REFRIGERANT R410A	7
4. CONSTRUCTION VIEWS	15
5. WIRING DIAGRAM	17
6. SPECIFICATIONS OF ELECTRICAL PARTS	18
7. REFRIGERANT CYCLE DIAGRAM	19
8. CONTROL BLOCK DIAGRAM	22
9. OPERATION DESCRIPTION	24
10. INSTALLATION PROCEDURE	48
11. HOW TO DIAGNOSE THE TROUBLE	64
12. HOW TO REPLACE THE MAIN PARTS	86
13. EXPLODED VIEWS AND PARTS LIST	102

1. SAFETY PRECAUTIONS

The manufacturer shall not assume any liability for the damage caused by not observing the description of this manual.

Be sure to read this installation manual carefully before installing.

Recommend to the owner to perform maintenance periodically when using over long periods of time.

Be sure to follow the precautions provided here to avoid safety risks. The symbols and their meanings are shown below.

DANGER : It indicates that incorrect use of this unit can result in a high possibility of severe injury (*1) or death.

WARNING : It indicates that incorrect use of this unit may cause severe injury of death.

CAUTION : It indicates that incorrect use of this unit may cause personal injury (*2) or property damage (*3).

*1 : A severe injury refers to blindness, injury, burns (hot or cold), electrical shock, bone fracture, or poisoning that leaves aftereffects and requires hospitalization or extended out-patient treatment.

*2 : Personal injury means a slight accident, burn, or electrical shock which does not require admission or repeated hospital treatment.

*3 : Property damage means greater damage which affects assets or resources.

For general public use

Power supply cord of parts of appliance for outdoor use shall be at least polychloroprene sheathed flexible cord (design H07RN-F) or cord designation 60245 IEC66 (1.5 mm² or more). (Shall be installed in accordance with national wiring regulations.)

CAUTION

New refrigerant air conditioner installation

- **THIS AIR CONDITIONER ADOPTS THE NEW HFC REFRIGERANT (R410A), WHICH DOES NOT DESTROY OZONE LAYER.**

R410A refrigerant is apt to be affected by impurities such as water, oxidizing membranes, and oils because the pressure of R410A refrigerant is approx. 1.6 times of refrigerant R22. As well as the adoption of this new refrigerant, refrigerating machine oil has also been changed. Therefore, during installation work, be sure that water, dust, former refrigerant, or refrigerating machine oil does not enter the refrigeration cycle of a new-refrigerant air conditioner. To avoid mixing refrigerant and refrigerating machine oil, the sizes of charging port connecting port connecting sections on the main unit are different from those for the conventional refrigerant, and different size tools are also required. For connecting pipes, use new and clean piping materials with highpressure withstand capabilities, designed for R410A only, and ensure that water or dust does not enter. Moreover, do not use any existing piping as its pressure withstand may be insufficient and may contain impurities.

DANGER

- FOR USE BY QUALIFIED PERSONS ONLY.
- MEANS FOR DISCONNECTION FROM THE SUPPLY HAVING A CONTACT SEPERATION OF AT LEAST 3 mm IN ALL POLES MUST BE INCORPORATED IN THE FIXED WIRING.
- TURN OFF MAIN POWER SUPPLY BEFORE ATTEMPTING ANY ELECTRICAL WORK, MAKE SURE ALL POWER SWITCHES ARE OFF FAILURE TO DO SO MAY CAUSE ELECTRIC SHOCK.
- CONNECT THE CONNECTING CABLE CORRECTLY. IF THE CONNECTING CABLE IS CONNECTED WRONGLY, ELECTRIC PARTS MAY BE DAMAGED.
- CHECK THE EARTH WIRE THAT IT IS NOT BROKEN OR DISCONNECTED BEFORE INSTALLATION.
- DO NOT INSTALL NEAR CONCENTRATIONS OF COMBUSTIBLE GAS OR GAS VAPORS. FAILURE TO FOLLOW THIS INSTRUCTION CAN RESULT IN FIRE OR EXPLOSION.
- TO PREVENT OVERHEATING THE INDOOR UNIT AND CAUSING A FIRE HAZARD, PLACE THE UNIT WELL AWAY (MORE THAN 2 M) FROM HEAT SOURCES SUCH AS RADIATORS, HEATERS, FURNACE, STOVES, ETC.
- WHEN MOVING THE AIR CONDITIONER FOR INSTALLING IT IN ANOTHER PLACE AGAIN, BE VERY CAREFUL NOT TO GET THE SPECIFIED REFRIGERANT (R410A) WITH ANY OTHER GASEOUS BODY INTO THE REFRIGERATION CYCLE. IF AIR OR ANY OTHER GAS IS MIXED IN THE REFRIGERANT, THE GAS PRESSURE IN THE REFRIGERATION CYCLE BECOMES ABNORMALLY HIGH AND IT RESULTINGLY CAUSES BURST OF THE PIPE AND INJURIES ON PERSONS.
- IN THE EVENT THAT THE REFRIGERANT GAS LEAKS OUT OF THE PIPE DURING THE INSTALLATION WORK, IMMEDIATELY LET FRESH AIR INTO THE ROOM. IF THE REFRIGERANT GAS IS HEATED BY FIRE OR SOMETHING ELSE, IT CAUSES GENERATION OF POISONOUS GAS.
- WHEN INSTALLING OR RE-INSTALLING THE AIR CONDITIONER, DO NOT INJECT AIR OR OTHER SUBSTANCES BESIDES THE DESIGNATED REFRIGERANT "R410A" INTO THE REFRIGERATION CYCLE. IF AIR OR OTHER SUBSTANCES ARE MIXED, AN ABNORMAL PRESSURE CAN OCCUR IN THE REFRIGERATING CYCLE, AND THIS CAN CAUSE AN INJURY DUE TO A PIPE RUPTURE.

WARNING

- Installation work must be requested from the supplying retail dealership or professional vendors. Self-installation may cause water leakage, electrical shock, or fire as a result of improper installation.
- Specified tools and pipe parts for model R410A are required, and installation work must be done in accordance with the manual. HFC type refrigerant R410A has 1.6 times more pressure than that of conventional refrigerant (R22). Use the specified pipe parts, and ensure correct installation, otherwise damage and/or injury may be caused. At the same time, water leakage, electrical shock, and fire may occur.
- Be sure to install the unit in a place which can sufficiently bear its weight. If the load bearing of the unit is not enough, or installation of the unit is improper, the unit may fall and result in injury.
- Electrical work must be performed by a qualified electrical engineer in accordance with the code governing such installation work, internal wiring regulations, and the manual. A dedicated circuit and the rated voltage must be used. Insufficient power supply or improper installation may cause electrical shock or fire.
- Use a cabletyre cable to connect wires in the indoor/outdoor units. Midway connection, stranded wire, and single-wire connections are not allowed. Improper connection or fixing may cause a fire.
- Wiring between the indoor unit and outdoor units must be well shaped so that the cover can be firmly placed. Improper cover installation may cause increased heat, fire, or electrical shock at the terminal area.
- Be sure to use only approved accessories or the specified parts. Failure to do so may cause the unit to fall, water leakage, fire or electrical shock.
- After the installation work, ensure that there is no leakage of refrigerant gas. If the refrigerant gas leaks out of the pipe into the room and is heated by fire or something else from a fan heater, stove or gas range, it causes generation of poisonous gas.
- Make sure the equipment is properly earthed. Do not connect the earth wire to a gas pipe, water pipe, lightning conductor, or telephone earth wire. Improper earth work may be the cause of electrical shock.
- Do not install the unit where flammable gas may leak. If there is any gas leakage or accumulation around the unit, it can cause a fire.
- Do not select a location for installation where there may be excessive water or humidity, such as a bathroom. Deterioration of insulation may cause electrical shock or fire.
- Installation work must be performed following the instructions in this installation manual. Improper installation may cause water leakage, electrical shock or fire. Check the following items before operating the unit.
 - Be sure that the pipe connection is well placed and there are no leaks.
 - Check that the service valve is open. If the service valve is closed, it may cause overpressure and result in compressor damage. At the same time, if there is a leak in the connection part, it may cause air suction and overpressure, resulting burst or injury.
- In pump down operations, ensure to perform the following procedures.
 - Do not inject air into the refrigeration cycle.
 - Be sure to close both service valves and stop the compressor before removing the refrigerant pipe. If removing the refrigerant pipe while the compressor is operating with the service valves opened, it may cause to air absorbed and abnormal high pressure inside the refrigeration cycle and resulting burst or injury.
- Do not modify the power cable, connect the cable midway, or use a multiple outlet extension cable. Doing so may cause contact failure, insulation failure, or excess current, resulting in fire or electrical shock.
- Do not use any refrigerant different from the one specified for complement or replacement. Otherwise, abnormally high pressure may be generated in the refrigeration cycle, which may result in a failure or explosion of the product or an injury to your body.
- Be sure to comply with local regulations/codes when running the wire from the outdoor unit to the indoor unit, (Size of wire and wiring method etc.).
- Places where iron or other metal dust is present. If iron or other metal dust adheres to or collects on the interior of the air conditioner, it may spontaneously combust and start a fire.
- If you detect any damage, do not install the unit. Contact your supplying dealer immediately.
- Never modify this unit by removing any of the safety guards.
- Do not install in a place which cannot bear the weight of the unit. Personal injury and property damage can result if the unit falls.

CAUTION

- Please read this installation manual carefully before installing the unit. It contains further important instructions for proper installation.
- Exposure of unit to water or other moisture before installation could result in electric shock. Do not store it in a wet basement or expose to rain or water.
- After unpacking the unit, examine it carefully for possible damage.
- Do not install in a place that can increase the vibration of the unit. Do not install in a place that can amplify the noise level of the unit or where noise and discharged air might disturb neighbors.
- This appliance must be connected to the main power supply by means of a circuit breaker depending on the place where the unit is installed. Failure to do so may cause electrical shock.
- Follow the instructions in this installation manual to arrange the drain pipe for proper drainage from the unit. Ensure that drained water is discharged. Improper drainage can result in water leakage, causing water damage to furniture.
- Tighten the flare nut with a torque wrench using the prescribed method. Do not apply excess torque. Otherwise, the nut may crack after a long period of usage and it may cause the leakage of refrigerant.
- Wear gloves (heavy gloves such as cotton gloves) for installation work. Failure to do so may cause personal injury when handling parts with sharp edges.
- Do not touch the air intake section or the aluminum fins of the outdoor unit. It may cause injury.
- Do not install the outdoor unit in a place which can be a nest for small animals. Small animals could enter and contact internal electrical parts, causing a failure or fire.
- Request the user to keep the place around the unit tidy and clean.
- Make sure to conduct a trial operation after the installation work, and explain how to use and maintain the unit to the customer in accordance with the manual. Ask the customer to keep the operation manual along with the installation manual.

2. SPECIFICATIONS

2-1. Specifications

Unit model		Indoor		RAS-18N3KV-E		RAS-22N3KV-E		
		Outdoor		RAS-18N3AV-E		RAS-22N3AV-E		
Cooling capacity			(kW)	5.0		6.0		
Cooling capacity range			(kW)	1.1 - 6.0		1.2 - 6.7		
Heating capacity			(kW)	5.8		7.0		
Heating capacity range			(kW)	0.8 - 6.3		1.0 - 7.5		
Power supply		1Ph/50Hz/220-240V, 1 Ph/60Hz/220-230V						
Electric characteristic	Indoor	Operation mode		Cooling	Heating	Cooling	Heating	
		Running current (220 - 240V)		(A)	0.30 - 0.28	0.30 - 0.28	0.38 - 0.35	0.38 - 0.35
		Power consumption		(W)	40	40	50	50
	Power factor		(%)	60	60	60	60	
	Outdoor	Operation mode		Cooling	Heating	Cooling	Heating	
		Running current (220 - 240V)		(A)	6.35 - 5.82	6.98 - 6.40	9.31 - 8.54	9.56 - 8.77
		Power consumption		(W)	1380	1520	1945	2000
		Power factor		(%)	99	99	99	99
	Starting current		(A)	-		-		
	COP				3.52	3.72	3.01	3.41
Sound Pressure level	Indoor	H/M+/M/L+/L	(dB-A)	44/41/38/35/32		47/44/42/38/35		
	Outdoor	H	(dB-A)	49	50	49	50	
Sound power level	Indoor	H/M+/M/L+/L	(dB-A)	59/56/53/50/47		62/59/57/53/50		
	Outdoor	H	(dB-A)	64	65	68	67	
Indoor unit	Unit model			RAS-18N3KV-E		RAS-22N3KV-E		
	Dimension	Height	(mm)	320		320		
		Width	(mm)	1050		1050		
		Depth	(mm)	243		243		
	Net weigh		(kg)	13		13		
	Fan motor output		(W)	30		30		
	Air flow rate (Cooling/Heating)		(m ³ / min)	15.9-16.5		18.0 - 18.3		
Outdoor unit	Unit model			RAS-18N3AV-E		RAS-22N3AV-E		
	Dimension	Height	(mm)	550		550		
		Width	(mm)	780		780		
		Depth	(mm)	290		290		
	Net weigh		(kg)	39		41		
	Compressor	Motor output		(W)	1100		1100	
		Type		Twin rotary type with DC-inverter variable speed control				
	Model			DA131S1B-31FZ		DA150A1F-20F		
	Fan motor output		(W)	43		43		
Air flow rate (Cooling/Heating)		(m ³ / min)	36.3 / 31.9		38.6 / 37.2			
Piping connection	Type			Flare connection		Flare connection		
	Indoor unit	Liquid side	(mm)	Ø6.35		Ø6.35		
		Gas side	(mm)	Ø12.70		Ø12.70		
	Outdoor unit	Liquid side	(mm)	Ø6.35		Ø6.35		
		Gas side	(mm)	Ø12.70		Ø12.70		
	Maximum length		(m)	20		20		
	Maximum chargeless length		(m)	15		15		
Maximum height difference		(m)	10		10			
Refrigerant	Name of refrigerant			R410A		R410A		
	Weight		(kg)	1.40		1.40		
Wiring connection		Power supply		3 Wires: Includes earth (Outdoor)				
		Interconnection		4 Wires: Includes earth				
Usable temperature range		Indoor (Cooling/Heating)		(°C)	21~32 / ~28		21~32 / ~28	
		Outdoor (Cooling/Heating)		(°C)	-10~46 / -15~24		-10~46 / -15~24	
Accessory	Indoor unit	Installation plate			1		1	
		Wireless remote controller			1		1	
		Batteries			2		2	
		Batteries cover			1		1	
		Remote controller holder			1		1	
		Toshiba New IAQ filter (Long)			2		2	
		Mounting screw			6 (Ø4 x 25L)		6 (Ø4 x 25L)	
		Pan head wood screw			2 (Ø3.1 x 16L), 1 (Ø3.1 x 25L)		2 (Ø3.1 x 16L), 1 (Ø3.1 x 25L)	
		Plasma air purifier			-		-	
		Installation instruction			1		1	
		Owner's manual			1		1	
		Outdoor unit	Drain nipple			1		1
	Water-proof rubber cap			2		2		

* The specification may be subject to change without notice for purpose of improvement.

2-2. Operation Characteristic Curve

<Cooling>

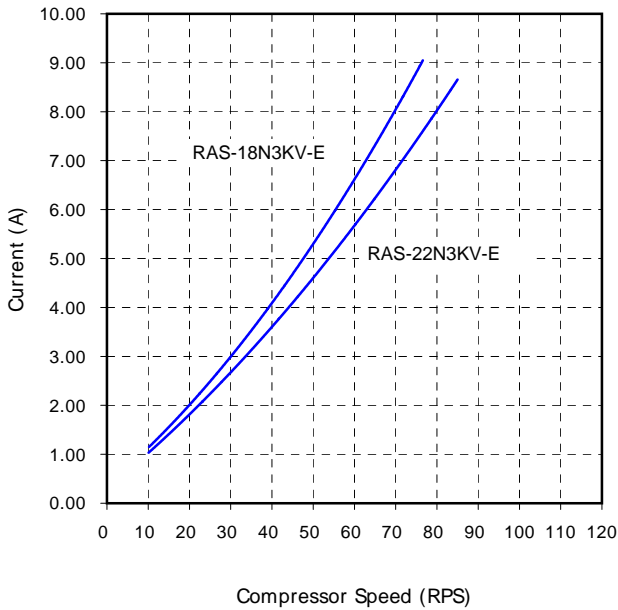

<Heating>

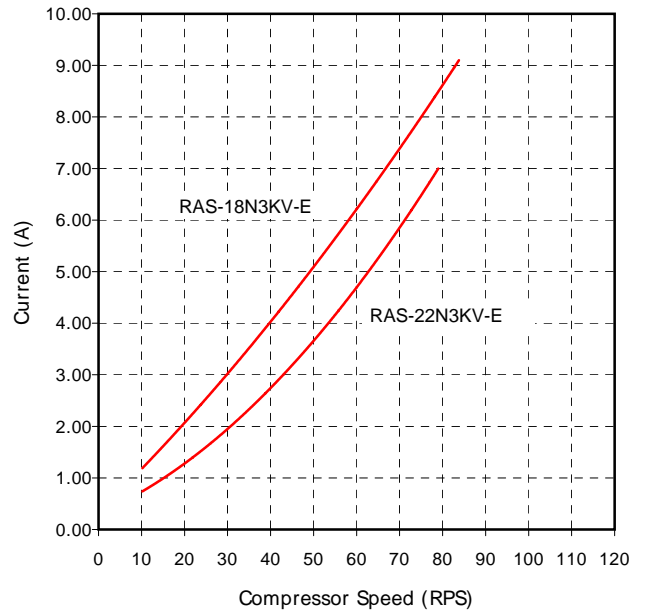

2-3. Capacity Variation Ratio According to Temperature

<Cooling>

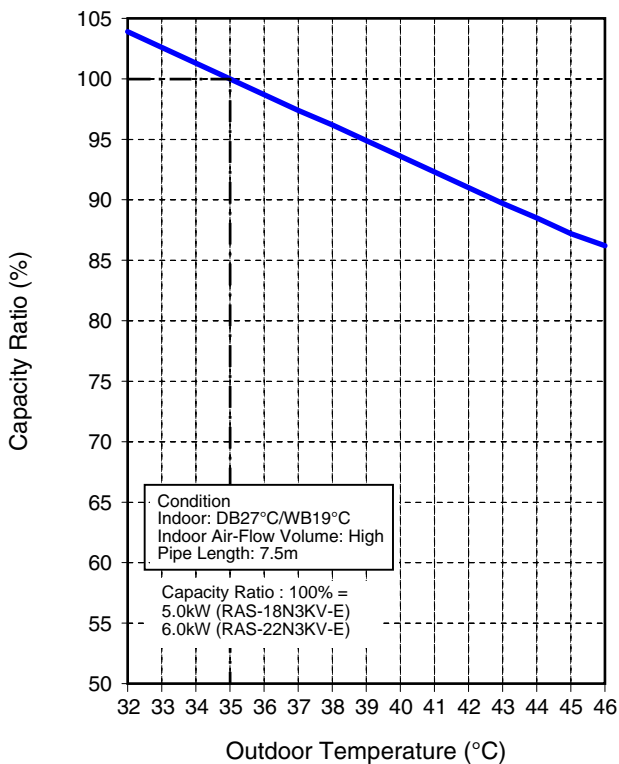

<Heating>

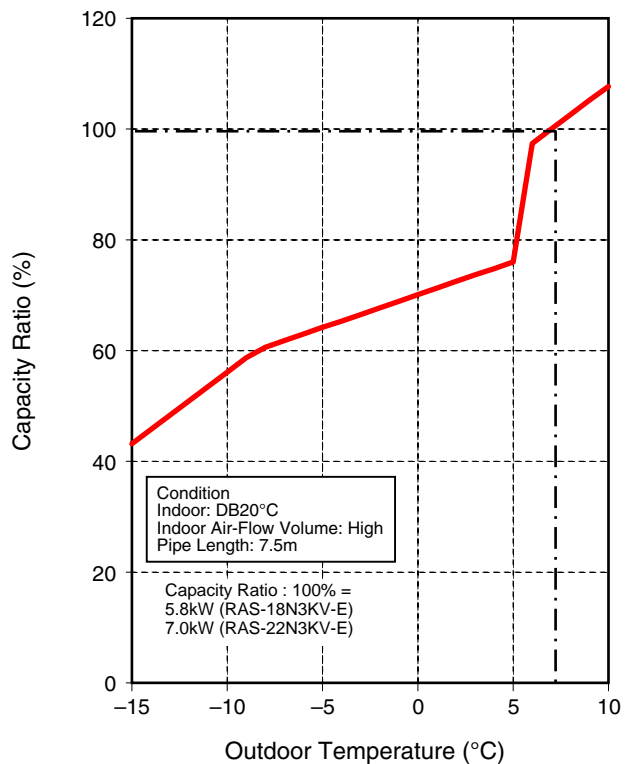

3. REFRIGERANT R410A

This air conditioner adopts the new refrigerant HFC (R410A) which does not damage the ozone layer. The working pressure of the new refrigerant R410A is 1.6 times higher than conventional refrigerant (R22). The refrigerating oil is also changed in accordance with change of refrigerant, so be careful that water, dust, and existing refrigerant or refrigerating oil are not entered in the refrigerant cycle of the air conditioner using the new refrigerant during installation work or servicing time.

The next section describes the precautions for air conditioner using the new refrigerant. Conforming to contents of the next section together with the general cautions included in this manual, perform the correct and safe work.

3-1. Safety During Installation/Servicing

As R410A's pressure is about 1.6 times higher than that of R22, improper installation/servicing may cause a serious trouble. By using tools and materials exclusive for R410A, it is necessary to carry out installation/servicing safely while taking the following precautions into consideration.

1. Never use refrigerant other than R410A in an air conditioner which is designed to operate with R410A.
If other refrigerant than R410A is mixed, pressure in the refrigeration cycle becomes abnormally high, and it may cause personal injury, etc. by a rupture.
2. Confirm the used refrigerant name, and use tools and materials exclusive for the refrigerant R410A.
The refrigerant name R410A is indicated on the visible place of the outdoor unit of the air conditioner using R410A as refrigerant. To prevent mischarging, the diameter of the service port differs from that of R22.
3. If a refrigeration gas leakage occurs during installation/servicing, be sure to ventilate fully.
If the refrigerant gas comes into contact with fire, a poisonous gas may occur.
4. When installing or removing an air conditioner, do not allow air or moisture to remain in the refrigeration cycle. Otherwise, pressure in the refrigeration cycle may become abnormally high so that a rupture or personal injury may be caused.
5. After completion of installation work, check to make sure that there is no refrigeration gas leakage.
If the refrigerant gas leaks into the room, coming into contact with fire in the fan-driven heater, space heater, etc., a poisonous gas may occur.

6. When an air conditioning system charged with a large volume of refrigerant is installed in a small room, it is necessary to exercise care so that, even when refrigerant leaks, its concentration does not exceed the marginal level.
If the refrigerant gas leakage occurs and its concentration exceeds the marginal level, an oxygen starvation accident may result.
7. Be sure to carry out installation or removal according to the installation manual.
Improper installation may cause refrigeration trouble, water leakage, electric shock, fire, etc.
8. Unauthorized modifications to the air conditioner may be dangerous.
If a breakdown occurs please call a qualified air conditioner technician or electrician.
Improper repair may result in water leakage, electric shock and fire, etc.

3-2. Refrigerant Piping Installation

3-2-1. Piping Materials and Joints Used

For the refrigerant piping installation, copper pipes and joints are mainly used.

Copper pipes and joints suitable for the refrigerant must be chosen and installed.

Furthermore, it is necessary to use clean copper pipes and joints whose interior surfaces are less affected by contaminants.

1. Copper Pipes

It is necessary to use seamless copper pipes which are made of either copper or copper alloy and it is desirable that the amount of residual oil is less than 40 mg/10 m.

Do not use copper pipes having a collapsed, deformed or discolored portion (especially on the interior surface).

Otherwise, the expansion valve or capillary tube may become blocked with contaminants.

As an air conditioner using R410A incurs pressure higher than when using R22, it is necessary to choose adequate materials.

Thicknesses of copper pipes used with R410A are as shown in Table 3-2-1.

Never use copper pipes thinner than 0.8 mm even when it is available on the market.

Table 3-2-1 Thicknesses of annealed copper pipes

		Thickness (mm)	
Nominal diameter	Outer diameter (mm)	R410A	R22
1/4	6.35	0.80	0.80
3/8	9.52	0.80	0.80
1/2	12.70	0.80	0.80
5/8	15.88	1.00	1.00

2. Joints

For copper pipes, flare joints or socket joints are used. Prior to use, be sure to remove all contaminants.

a) Flare Joints

Flare joints used to connect the copper pipes cannot be used for pipings whose outer diameter exceeds 20 mm. In such a case, socket joints can be used.

Sizes of flare pipe ends, flare joint ends and flare nuts are as shown in Tables 3-2-3 to 3-2-6 below.

b) Socket Joints

Socket joints are such that they are brazed for connections, and used mainly for thick pipings whose diameter is larger than 20 mm.

Thicknesses of socket joints are as shown in Table 3-2-2.

Table 3-2-2 Minimum thicknesses of socket joints

Nominal diameter	Reference outer diameter of copper pipe jointed (mm)	Minimum joint thickness (mm)
1/4	6.35	0.50
3/8	9.52	0.60
1/2	12.70	0.70
5/8	15.88	0.80

3-2-2. Processing of Piping Materials

When performing the refrigerant piping installation, care should be taken to ensure that water or dust does not enter the pipe interior, that no other oil than lubricating oils used in the installed air-water heat pump is used, and that refrigerant does not leak.

When using lubricating oils in the piping processing, use such lubricating oils whose water content has been removed. When stored, be sure to seal the container with an airtight cap or any other cover.

1. Flare processing procedures and precautions

a) Cutting the Pipe

By means of a pipe cutter, slowly cut the pipe so that it is not deformed.

b) Removing Burrs and Chips

If the flared section has chips or burrs, refrigerant leakage may occur.

Carefully remove all burrs and clean the cut surface before installation.

c) Insertion of Flare Nut

d) Flare Processing

Make certain that a clamp bar and copper pipe have been cleaned.

By means of the clamp bar, perform the flare processing correctly.

Use either a flare tool for R410A or conventional flare tool.

Flare processing dimensions differ according to the type of flare tool.

When using a conventional flare tool, be sure to secure "dimension A" by using a gauge for size adjustment.

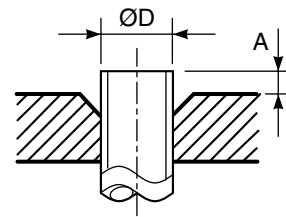

Fig. 3-2-1 Flare processing dimensions

Table 3-2-3 Dimensions related to flare processing for R410A

Nominal diameter	Outer diameter (mm)	Thickness (mm)	A (mm)		
			Flare tool for R410A clutch type	Conventional flare tool	
				Clutch type	Wing nut type
1/4	6.35	0.8	0 to 0.5	1.0 to 1.5	1.5 to 2.0
3/8	9.52	0.8	0 to 0.5	1.0 to 1.5	1.5 to 2.0
1/2	12.70	0.8	0 to 0.5	1.0 to 1.5	2.0 to 2.5
5/8	15.88	1.0	0 to 0.5	1.0 to 1.5	2.0 to 2.5

Table 3-2-4 Dimensions related to flare processing for R22

Nominal diameter	Outer diameter (mm)	Thickness (mm)	A (mm)		
			Flare tool for R22 clutch type	Conventional flare tool	
				Clutch type	Wing nut type
1/4	6.35	0.8	0 to 0.5	0.5 to 1.0	1.0 to 1.5
3/8	9.52	0.8	0 to 0.5	0.5 to 1.0	1.0 to 1.5
1/2	12.70	0.8	0 to 0.5	0.5 to 1.0	1.5 to 2.0
5/8	15.88	1.0	0 to 0.5	0.5 to 1.0	1.5 to 2.0

Table 3-2-5 Flare and flare nut dimensions for R410A

Nominal diameter	Outer diameter (mm)	Thickness (mm)	Dimension (mm)				Flare nut width (mm)
			A	B	C	D	
1/4	6.35	0.8	9.1	9.2	6.5	13	17
3/8	9.52	0.8	13.2	13.5	9.7	20	22
1/2	12.70	0.8	16.0	16.6	12.9	23	26
5/8	15.88	1.0	19.0	19.7	16.0	25	29

Table 3-2-6 Flare and flare nut dimensions for R22

Nominal diameter	Outer diameter (mm)	Thickness (mm)	Dimension (mm)				Flare nut width (mm)
			A	B	C	D	
1/4	6.35	0.8	9.0	9.2	6.5	13	17
3/8	9.52	0.8	13.0	13.5	9.7	20	22
1/2	12.70	0.8	16.0	16.2	12.9	20	24
5/8	15.88	1.0	19.0	19.7	16.0	23	27
3/4	19.05	1.0	23.3	24.0	19.2	34	36

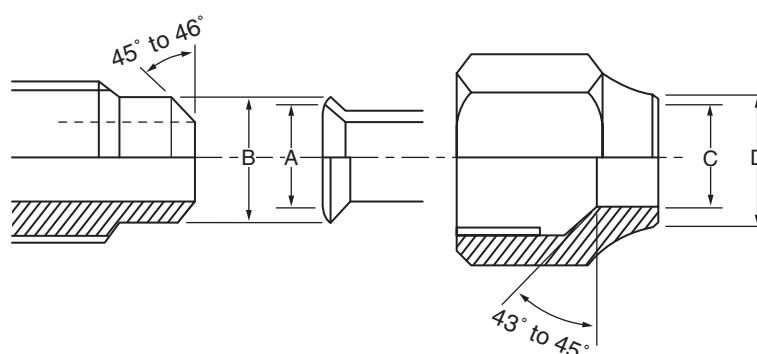

Fig. 3-2-2 Relations between flare nut and flare seal surface

2. Flare Connecting Procedures and Precautions

- Make sure that the flare and union portions do not have any scar or dust, etc.
- Correctly align the processed flare surface with the union axis.
- Tighten the flare with designated torque by means of a torque wrench.

The tightening torque for R410A is the same as that for conventional R22.

Incidentally, when the torque is weak, the gas leakage may occur.

When it is strong, the flare nut may crack and may be made non-removable.

When choosing the tightening torque, comply with values designated by manufacturers.

Table 3-2-7 shows reference values.

NOTE :

When applying oil to the flare surface, be sure to use oil designated by the manufacturer.

If any other oil is used, the lubricating oils may deteriorate and cause the compressor to burn out.

Table 3-2-7 Tightening torque of flare for R410A [Reference values]

Nominal diameter	Outer diameter (mm)	Tightening torque N•m (kgf•cm)	Tightening torque of torque wrenches available on the market N•m (kgf•cm)
1/4	6.35	14 to 18 (140 to 180)	16 (160), 18 (180)
3/8	9.52	33 to 42 (330 to 420)	42 (420)
1/2	12.70	50 to 62 (500 to 620)	55 (550)
5/8	15.88	63 to 77 (630 to 770)	65 (650)

3-3. Tools

3-3-1. Required Tools

The service port diameter of packed valve of the outdoor unit in the air-water heat pump using R410A is changed to prevent mixing of other refrigerant.

To reinforce the pressure-resisting strength, flare processing dimensions and opposite side dimension of flare nut (For Ø12.7 copper pipe) of the refrigerant piping are lengthened.

The used refrigerating oil is changed, and mixing of oil may cause a trouble such as generation of sludge, clogging of capillary, etc. Accordingly, the tools to be used are classified into the following three types.

1. Tools exclusive for R410A (Those which cannot be used for conventional refrigerant (R22))
2. Tools exclusive for R410A, but can be also used for conventional refrigerant (R22)
3. Tools commonly used for R410A and for conventional refrigerant (R22)

The table below shows the tools exclusive for R410A and their interchangeability.

Tools whose specifications are changed for R410A and their interchangeability

No.	Used tool	Usage	R410A air-water heat pump installation		Conventional air-water heat pump installation
			Existence of new equipment for R410A	Whether conventional equipment can be used	Whether new equipment can be used with conventional refrigerant
1	Flare tool	Pipe flaring	Yes	* (Note 1)	Yes
2	Copper pipe gauge for adjusting projection margin	Flaring by conventional flare tool	Yes	* (Note 1)	* (Note 1)
3	Torque wrench (For Ø12.7)	Connection of flare nut	Yes	No	No
4	Gauge manifold	Evacuating, refrigerant charge, run check, etc.	Yes	No	No
5	Charge hose				
6	Vacuum pump adapter	Vacuum evacuating	Yes	No	Yes
7	Electronic balance for refrigerant charging	Refrigerant charge	Yes	No	Yes
8	Refrigerant cylinder	Refrigerant charge	Yes	No	No
9	Leakage detector	Gas leakage check	Yes	No	Yes
10	Charging cylinder	Refrigerant charge	* (Note 2)	No	No

(Note 1) When flaring is carried out for R410A using the conventional flare tools, adjustment of projection margin is necessary. For this adjustment, a copper pipe gauge, etc. are necessary.

(Note 2) Charging cylinder for R410A is being currently developed.

In addition to the above exclusive tools, the following equipments which serve also for R22 are necessary as the general tools.

- | | | |
|--|-----------------------------|---|
| 1. Vacuum pump
Use vacuum pump by attaching
vacuum pump adapter. | 4. Reamer | 9. Hole core drill (Ø65) |
| 2. Torque wrench (For Ø6.35, Ø9.52) | 5. Pipe bender | 10. Hexagon wrench
(Opposite side 4mm) |
| 3. Pipe cutter | 6. Level vial | 11. Tape measure |
| | 7. Screwdriver (+, -) | 12. Metal saw |
| | 8. Spanner or Monkey wrench | |

Also prepare the following equipments for other installation method and run check.

- | | |
|----------------|---------------------------------|
| 1. Clamp meter | 3. Insulation resistance tester |
| 2. Thermometer | 4. Electroscopes |

3-4. Recharging of Refrigerant

When it is necessary to recharge refrigerant, charge the specified amount of new refrigerant according to the following steps.

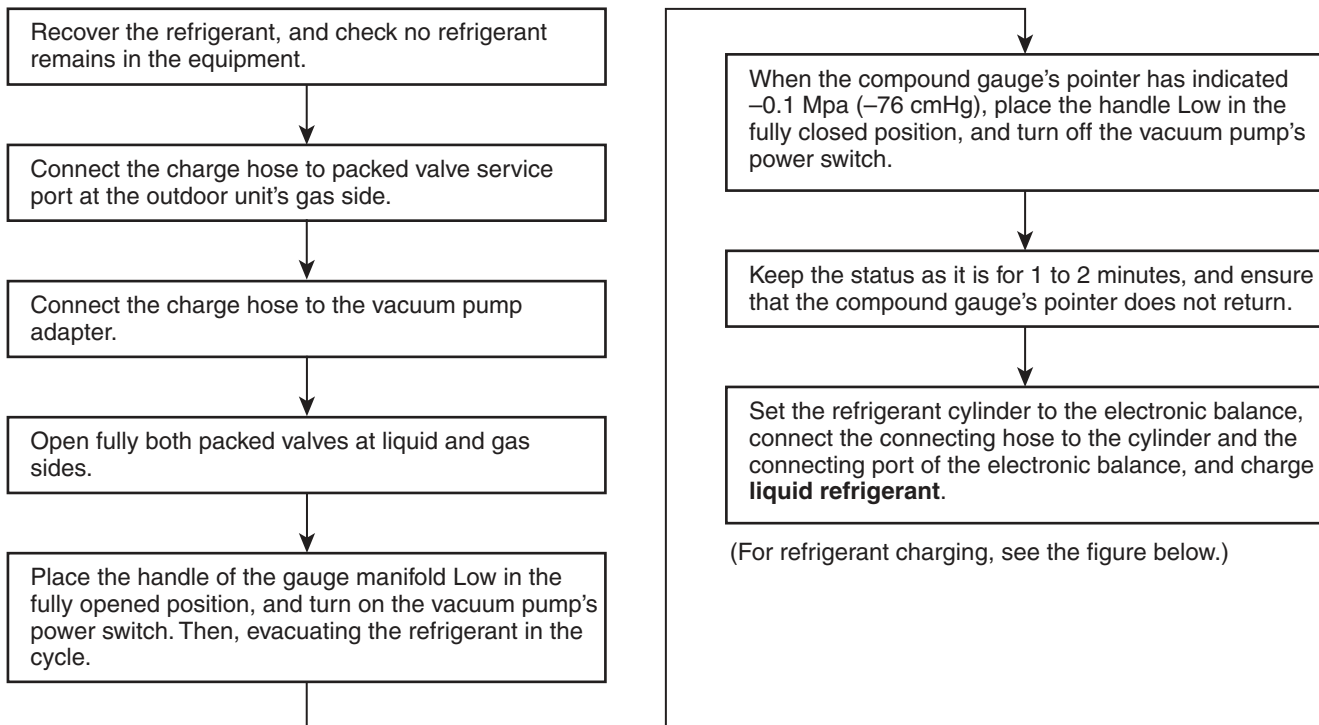

1. Never charge refrigerant exceeding the specified amount.
2. If the specified amount of refrigerant cannot be charged, charge refrigerant **bit by bit** in COOL mode.
3. Do not carry out additional charging.

When additional charging is carried out if refrigerant leaks, the refrigerant composition changes in the refrigeration cycle, that is characteristics of the air conditioner changes, refrigerant exceeding the specified amount is charged, and working pressure in the refrigeration cycle becomes abnormally high pressure, and may cause a rupture or personal injury.

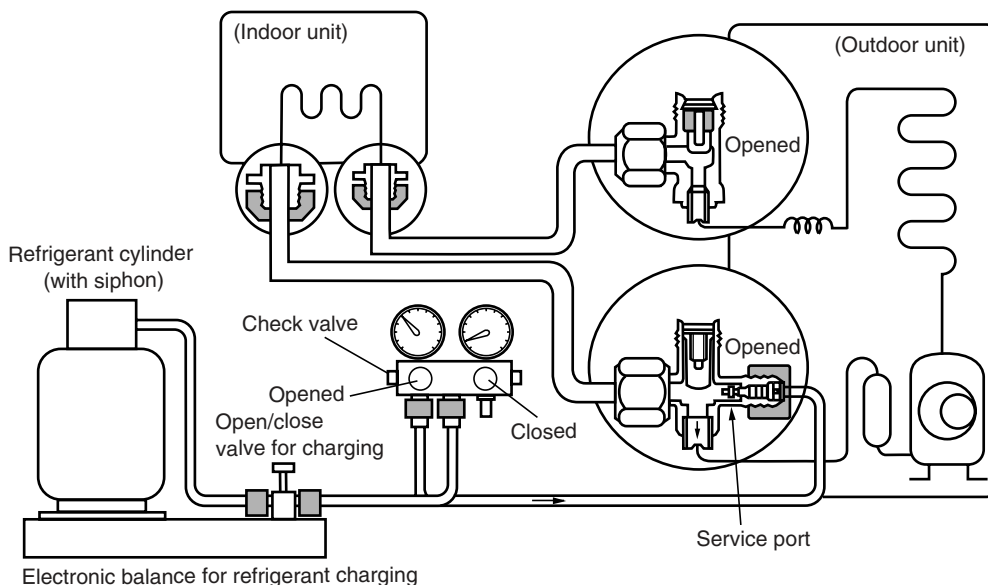
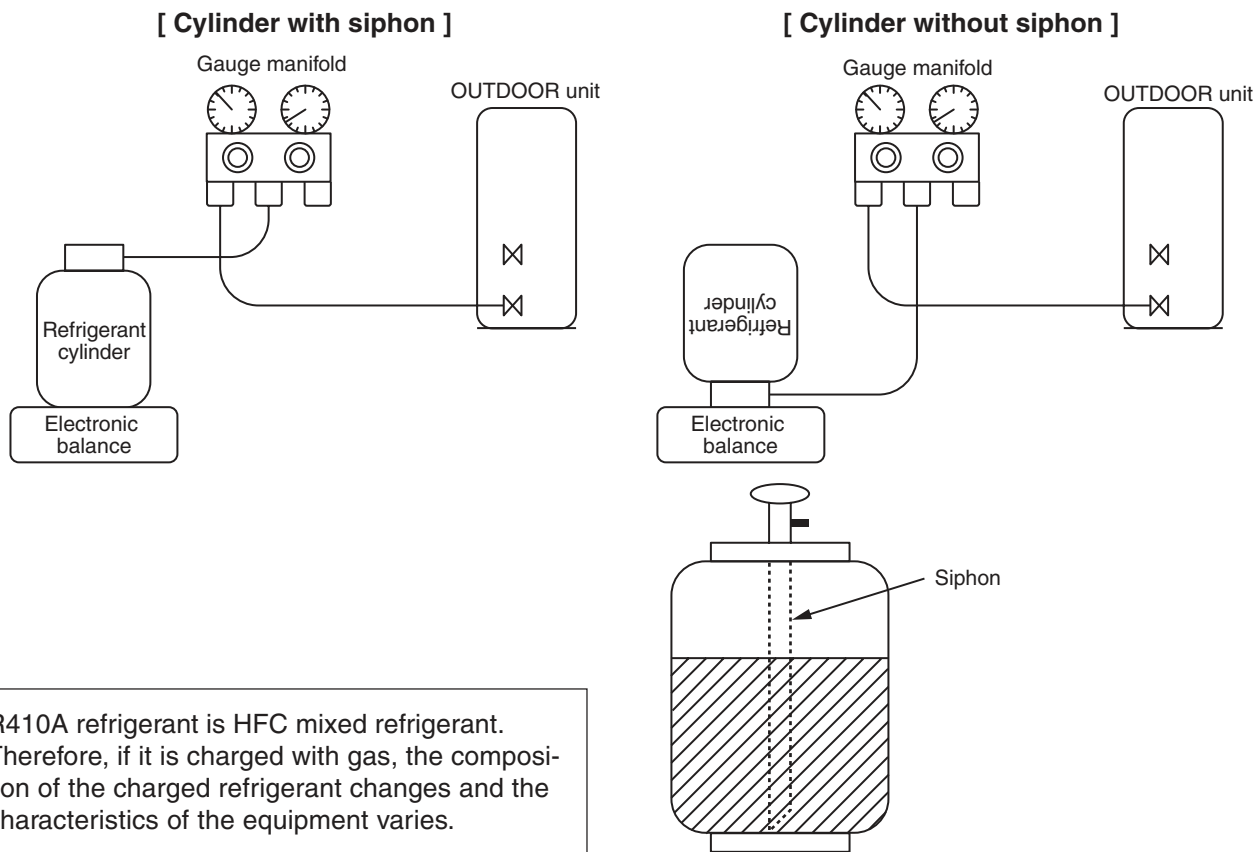

Fig. 3-4-1 Configuration of refrigerant charging

1. Be sure to make setting so that **liquid** can be charged.
2. When using a cylinder equipped with a siphon, liquid can be charged without turning it upside down.

It is necessary for charging refrigerant under condition of liquid because R410A is mixed type of refrigerant. Accordingly, when charging refrigerant from the refrigerant cylinder to the equipment, charge it turning the cylinder upside down if cylinder is not equipped with siphon.



R410A refrigerant is HFC mixed refrigerant. Therefore, if it is charged with gas, the composition of the charged refrigerant changes and the characteristics of the equipment varies.

Fig. 3-4-2

3-5. Brazing of Pipes

3-5-1. Materials for Brazing

1. Silver brazing filler

Silver brazing filler is an alloy mainly composed of silver and copper. It is used to join iron, copper or copper alloy, and is relatively expensive though it excels in solderability.

2. Phosphor bronze brazing filler

Phosphor bronze brazing filler is generally used to join copper or copper alloy.

3. Low temperature brazing filler

Low temperature brazing filler is generally called solder, and is an alloy of tin and lead. Since it is weak in adhesive strength, do not use it for refrigerant pipes.

1. Phosphor bronze brazing filler tends to react with sulfur and produce a fragile compound water solution, which may cause a gas leakage. Therefore, use any other type of brazing filler at a hot spring resort, etc., and coat the surface with a paint.
2. When performing brazing again at time of servicing, use the same type of brazing filler.

3-5-2. Flux

1. Reason why flux is necessary

- By removing the oxide film and any foreign matter on the metal surface, it assists the flow of brazing filler.
- In the brazing process, it prevents the metal surface from being oxidized.
- By reducing the brazing filler's surface tension, the brazing filler adheres better to the treated metal.

2. Characteristics required for flux

- Activated temperature of flux coincides with the brazing temperature.
- Due to a wide effective temperature range, flux is hard to carbonize.
- It is easy to remove slag after brazing.
- The corrosive action to the treated metal and brazing filler is minimum.
- It excels in coating performance and is harmless to the human body.

As the flux works in a complicated manner as described above, it is necessary to select an adequate type of flux according to the type and shape of treated metal, type of brazing filler and brazing method, etc.

3. Types of flux

• Noncorrosive flux

Generally, it is a compound of borax and boric acid.

It is effective in case where the brazing temperature is higher than 800°C.

• Activated flux

Most of fluxes generally used for silver brazing are this type.

It features an increased oxide film removing capability due to the addition of compounds such as potassium fluoride, potassium chloride and sodium fluoride to the borax-boric acid compound.

4. Piping materials for brazing and used brazing filler/flux

Piping material	Used brazing filler	Used flux
Copper - Copper	Phosphor copper	Do not use
Copper - Iron	Silver	Paste flux
Iron - Iron	Silver	Vapor flux

1. Do not enter flux into the refrigeration cycle.
2. When chlorine contained in the flux remains within the pipe, the lubricating oil deteriorates. Therefore, use a flux which does not contain chlorine.
3. When adding water to the flux, use water which does not contain chlorine (e.g. distilled water or ion-exchange water).
4. Remove the flux after brazing.

3-5-3. Brazing

As brazing work requires sophisticated techniques, experiences based upon a theoretical knowledge, it must be performed by a person qualified.

In order to prevent the oxide film from occurring in the pipe interior during brazing, it is effective to proceed with brazing while letting dry Nitrogen gas (N₂) flow.

Never use gas other than Nitrogen gas.

1. Brazing method to prevent oxidation

- 1) Attach a reducing valve and a flow-meter to the Nitrogen gas cylinder.
- 2) Use a copper pipe to direct the piping material, and attach a flow-meter to the cylinder.
- 3) Apply a seal onto the clearance between the piping material and inserted copper pipe for Nitrogen in order to prevent backflow of the Nitrogen gas.
- 4) When the Nitrogen gas is flowing, be sure to keep the piping end open.
- 5) Adjust the flow rate of Nitrogen gas so that it is lower than 0.05 m³/Hr or 0.02 MPa (0.2kgf/cm²) by means of the reducing valve.
- 6) After performing the steps above, keep the Nitrogen gas flowing until the pipe cools down to a certain extent (temperature at which pipes are touchable with hands).
- 7) Remove the flux completely after brazing.

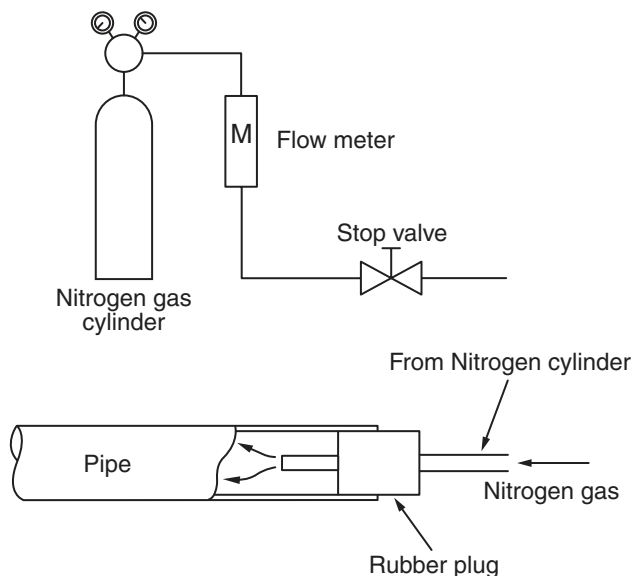
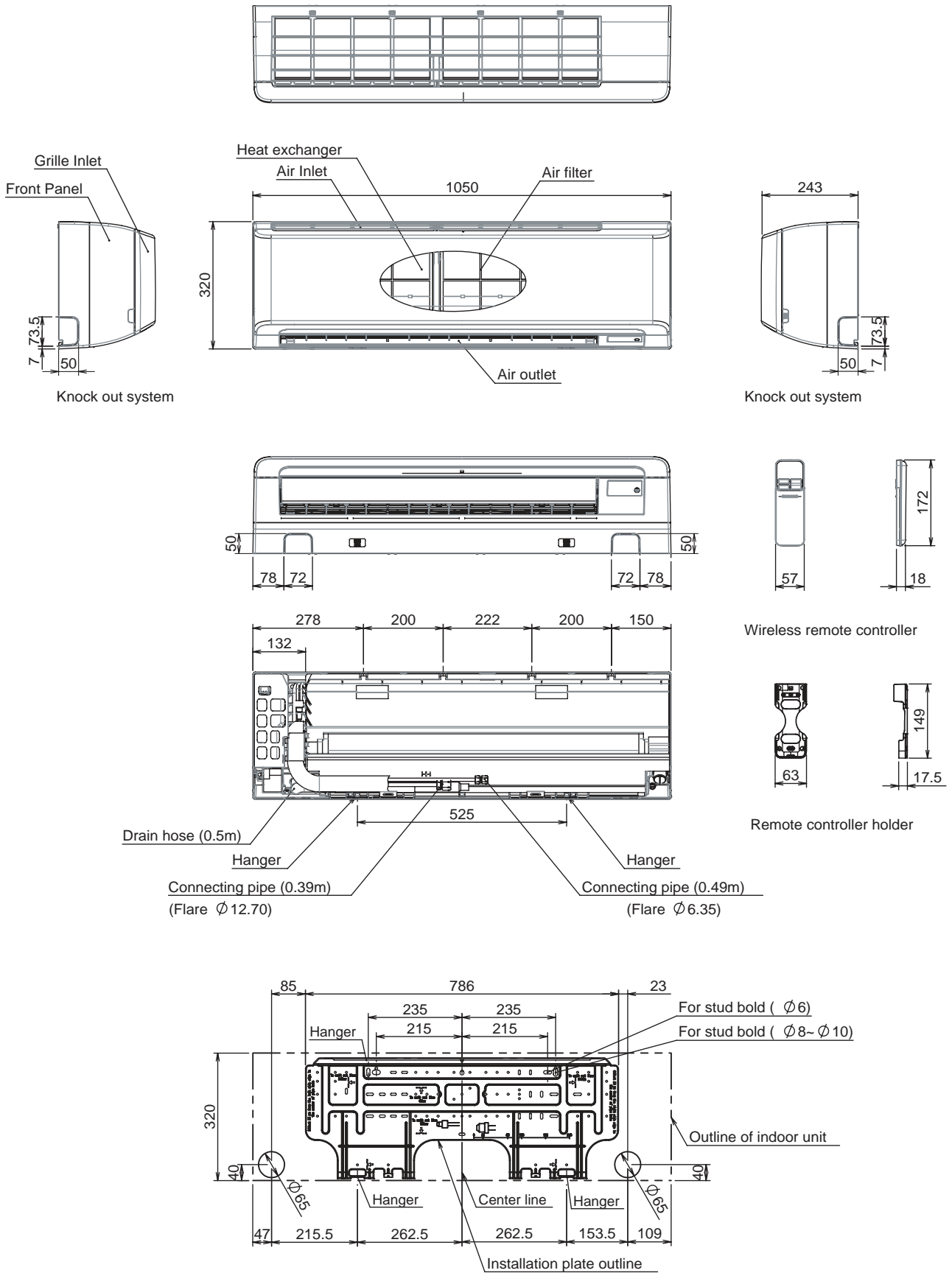

Fig. 3-5-1
Prevention of oxidation during brazing

4-1. Indoor Unit

4. CONSTRUCTION VIEWS



4-2. Outdoor Unit

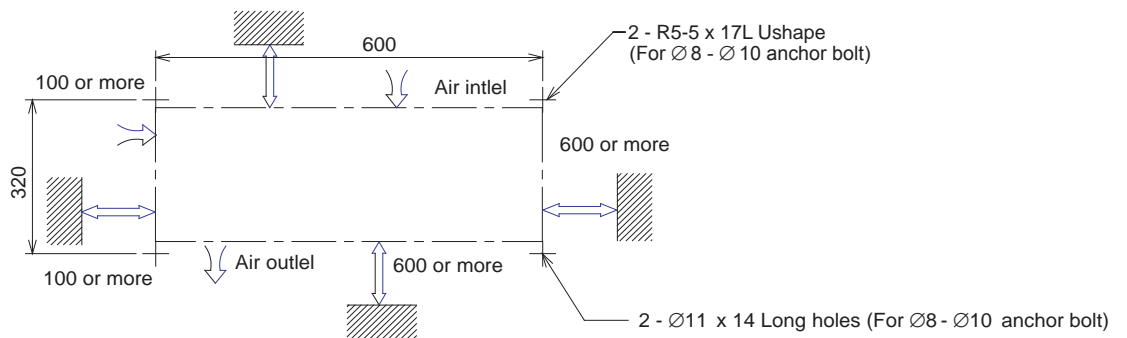
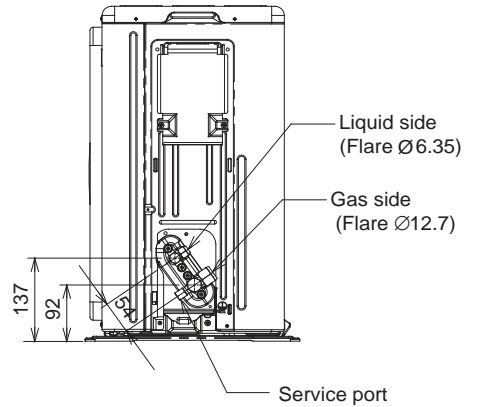
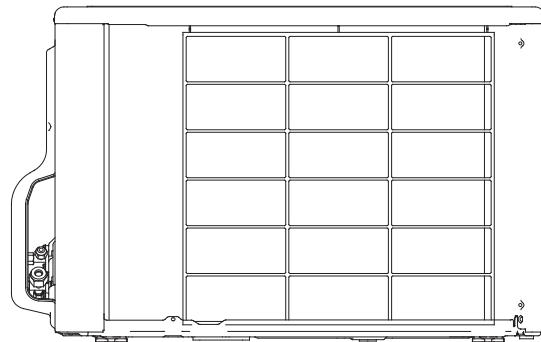
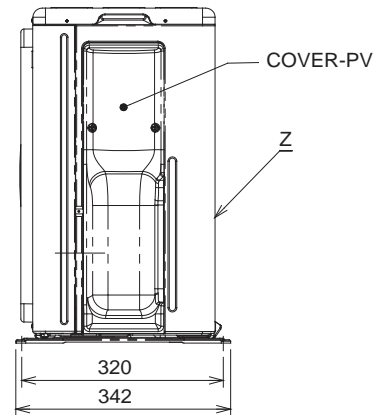
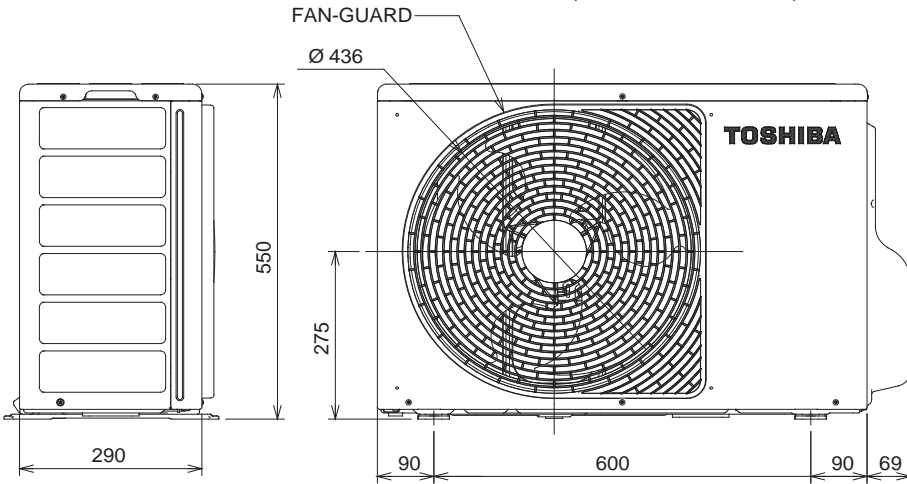
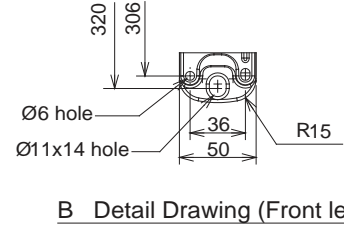
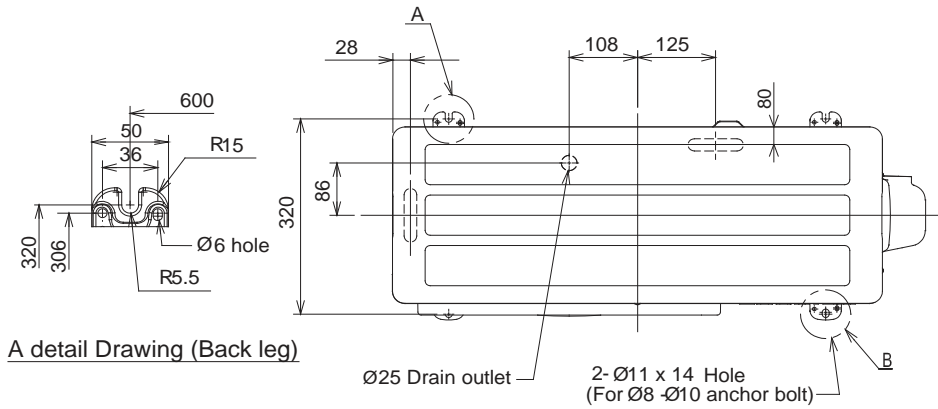

Installation dimension

5. WIRING DIAGRAM

5-1. Indoor Unit / Outdoor Unit

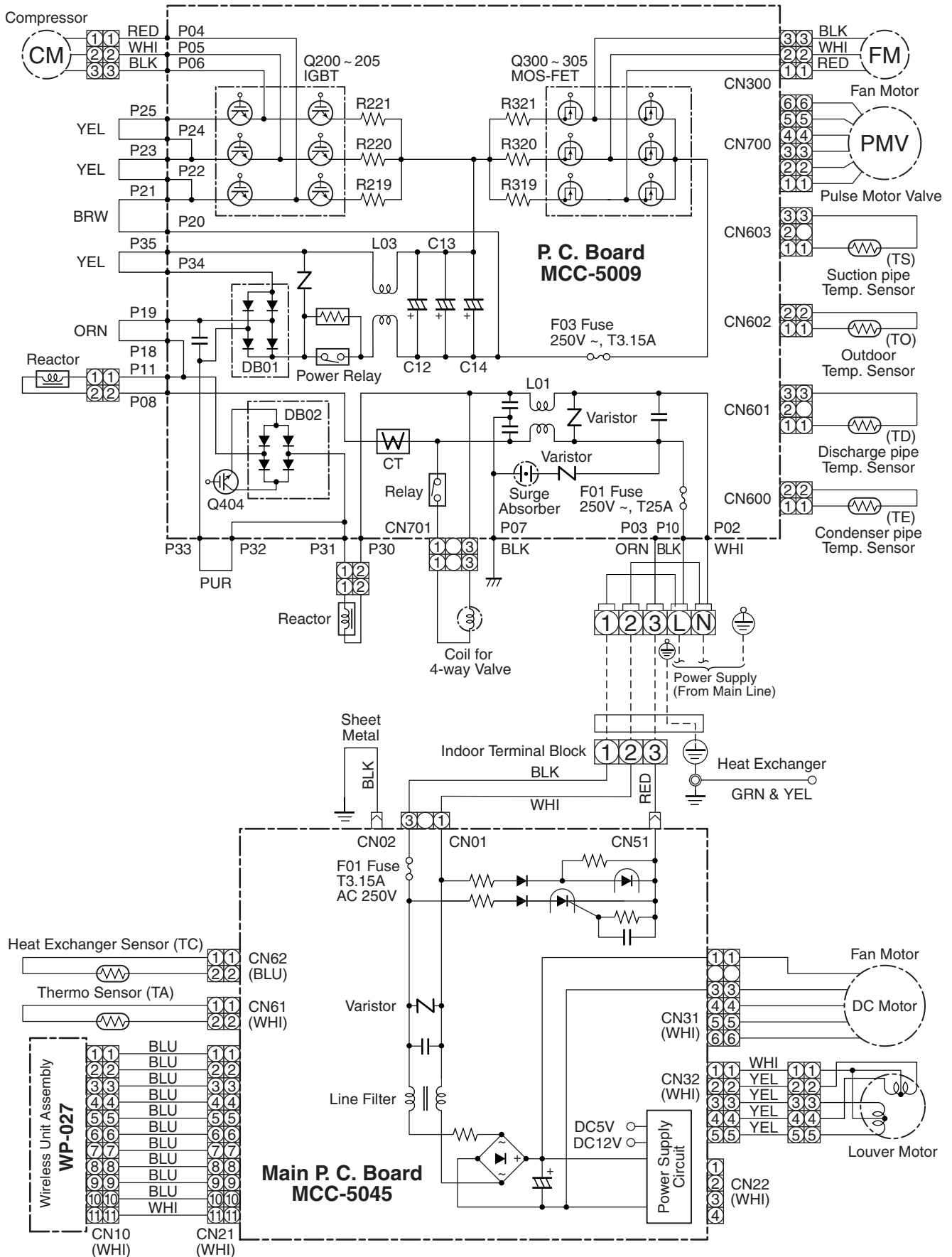

6. SPECIFICATIONS OF ELECTRICAL PARTS

6-1. Indoor Unit

No.	Parts name	Model name	Rating
1	Fan motor (for indoor)	MF-340-30-3	DC340V, 30W
2	Room temp. sensor (TA-sensor)	(—)	10kΩ at 25°C
3	Heat exchanger temp. sensor (TC-sensor)	(—)	10kΩ at 25°C
4	Louver motor	MSBPC20F04	DC12V, 4phase, 16pole

6-2. Outdoor Unit

No.	Parts name	Model name	Rating
1	Reactor	CH-57-Z-T	L = 10mH, 16A
2	Outdoor fan motor	ICF-140-43-4R	DC140V, 43W
3	Suction temp. sensor (TS sensor)	(Inverter attached)	10kΩ (25°C)
4	Discharge temp. sensor (TD sensor)	(Inverter attached)	62kΩ (20°C), 3.3kΩ (100°C)
5	Outside air temp. sensor (TO sensor)	(Inverter attached)	10kΩ (25°C)
6	Heat exchanger temp. sensor (TE sensor)	(Inverter attached)	10kΩ (25°C)
7	Terminal block (5P)	JXO-5B	20A, AC250V
8	Compressor	RAS-18N3AV-E	DA131S1B-31FZ
		RAS-22N3AV-E	DA150A1F-20F
			3phases 4poles 1100W
9	Coil for PMV	CAM-MD12TCTH-5	DC12V
10	Coil for 4-way valve	RAS-18N3AV-E	STF-01AJ646A1
		RAS-22N3AV-E	STF-01AJ503K1
			AC220-240V

7. REFRIGERANT CYCLE DIAGRAM

7-1. Refrigerant Cycle Diagram

RAS-18N3KV-E / RAS-18N3AV-E

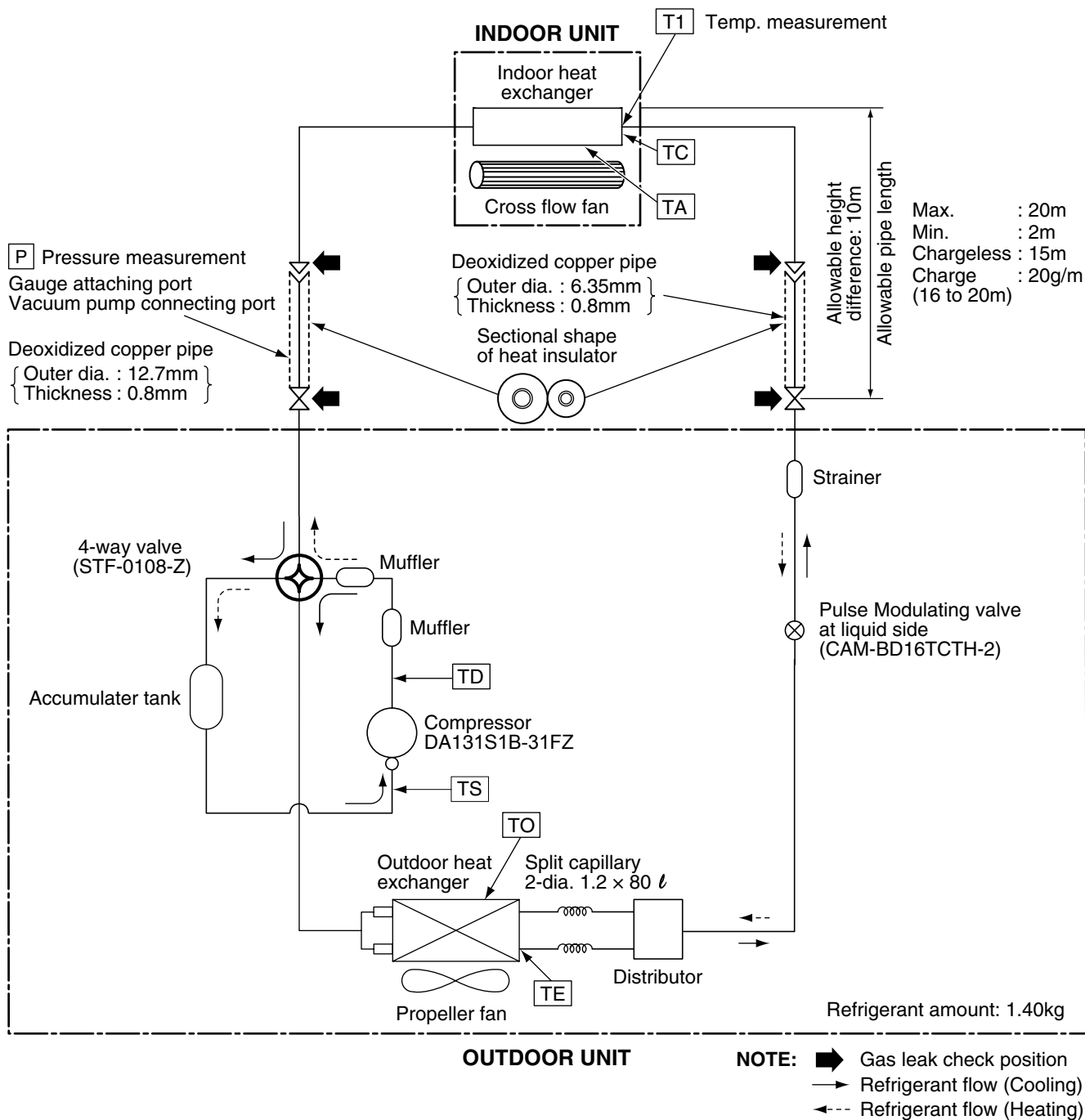

NOTE :

- The maximum pipe length of this air conditioner is 20m. When the pipe length exceeds 15m, the additional charging of refrigerant, 20g per 1m for the part of pipe exceeded 15m is required. (Max. 100g)

RAS-22N3KV-E / RAS-22N3AV-E

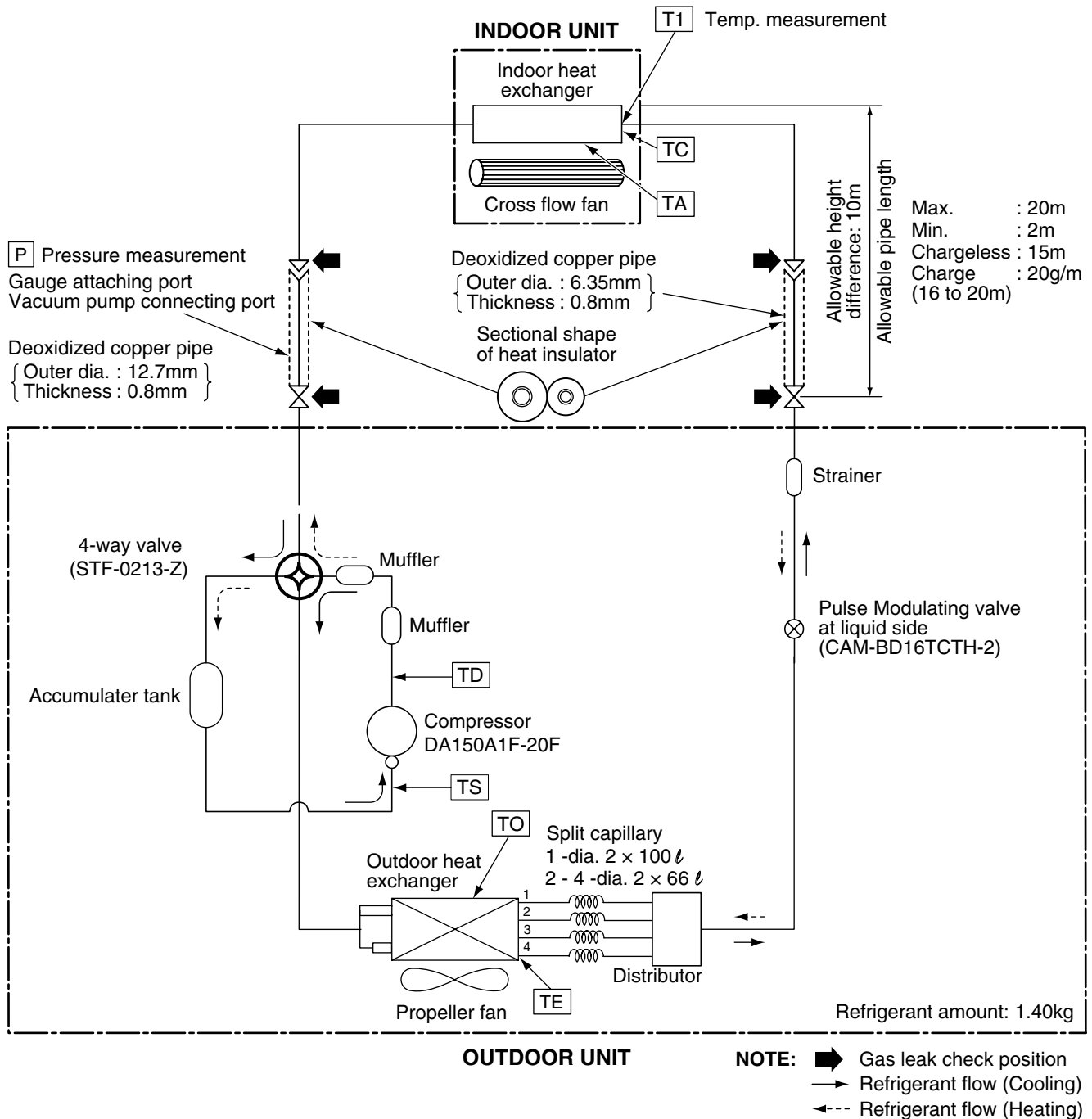

NOTE :

- The maximum pipe length of this air conditioner is 15m. When the pipe length exceeds 15m, the additional charging of refrigerant, 20g per 1m for the part of pipe exceeded 15m is required. (Max. 100g)

7-2. Operation Data**<Cooling>**

Temperature condition(°C)		Model name RAS-	Standard pressure P (MPa)	Heat exchanger pipe temp.		Indoor fan mode	Outdoor fan mode	Compressor revolution (rps)
Indoor	Outdoor			T1 (°C)	T2 (°C)			
27/19	35/24	18N3KV-E	0.9 to 1.1	11 to 13	40 to 42	High	High	67
		22N3KV-E	0.9 to 1.1	11 to 13	41 to 43			77

<Heating>

Temperature condition(°C)		Model name RAS-	Standard pressure P (MPa)	Heat exchanger pipe temp.		Indoor fan mode	Outdoor fan mode	Compressor revolution (rps)
Indoor	Outdoor			T1 (°C)	T2 (°C)			
20/15	7/6	18N3KV-E	2.5 to 2.6	40 to 42	1 to 3	High	High	79
		22N3KV-E	2.6 to 2.8	42 to 44	0 to 2			84

NOTES :

1. Measure surface temperature of heat exchanger pipe around center of heat exchanger path U bent.
(Thermistor thermometer)
2. Connecting piping condition : 7.5 m

8. CONTROL BLOCK DIAGRAM

8-1. Indoor Unit

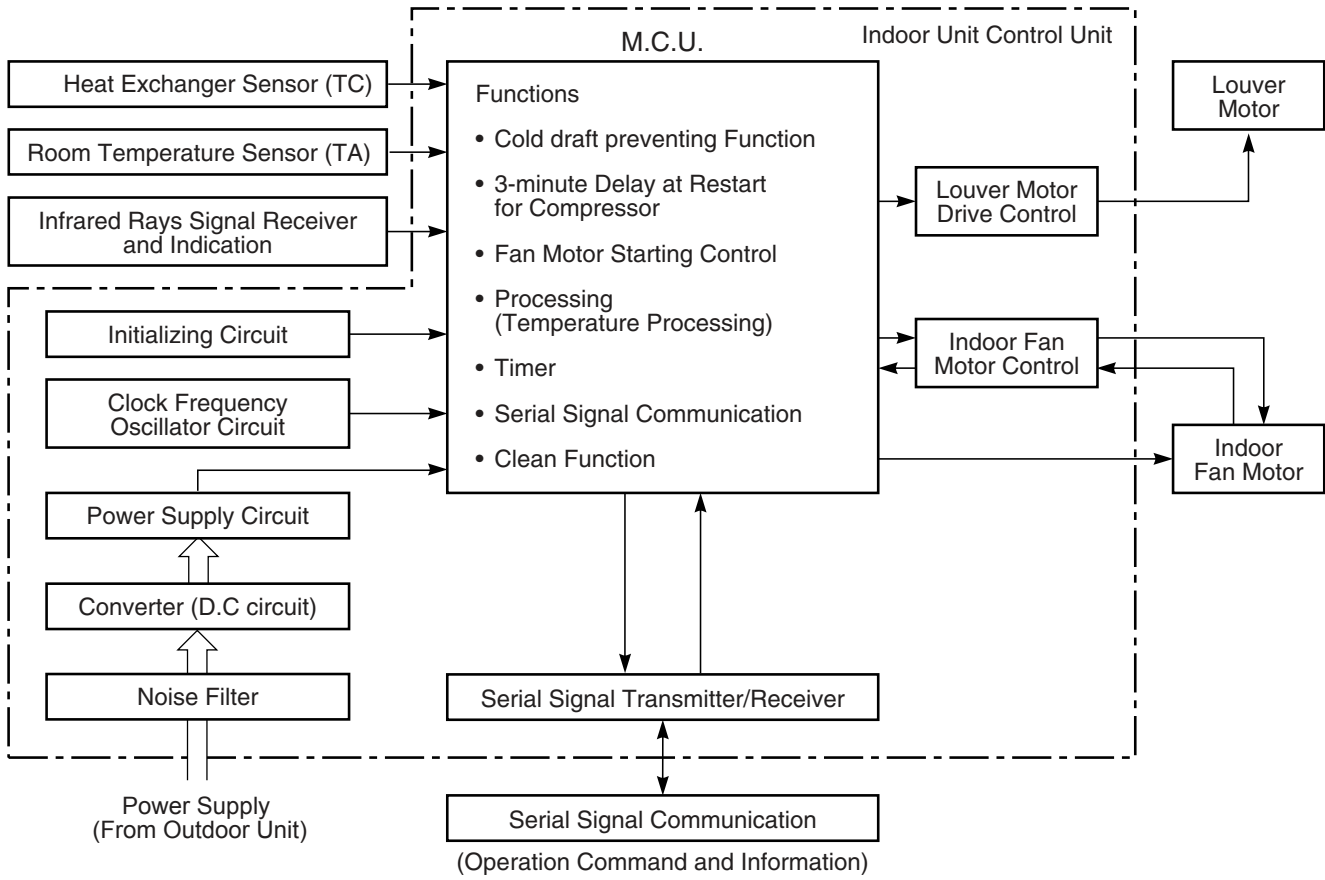

REMOTE CONTROLLER

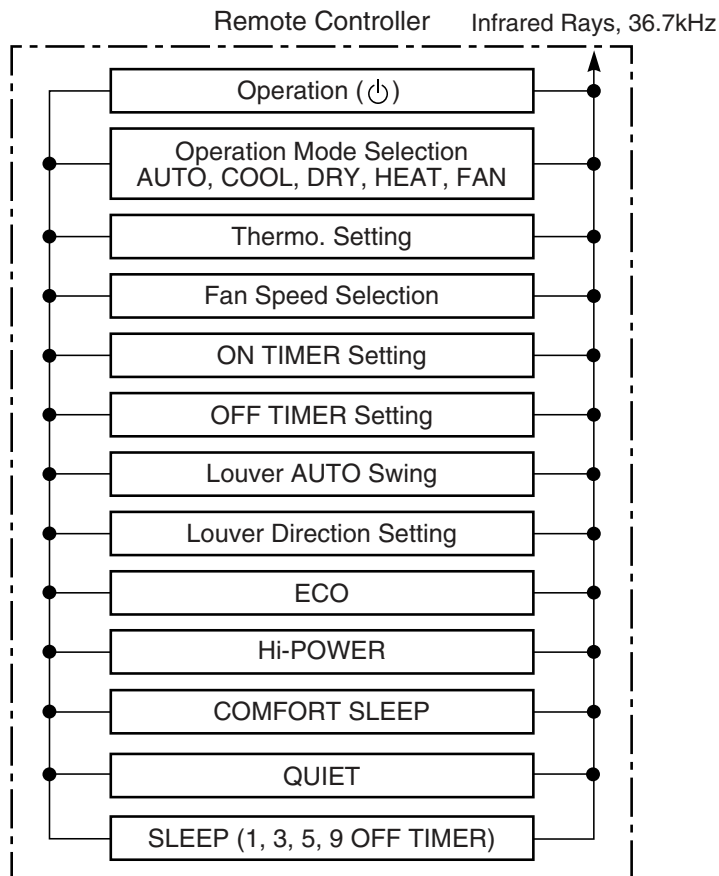

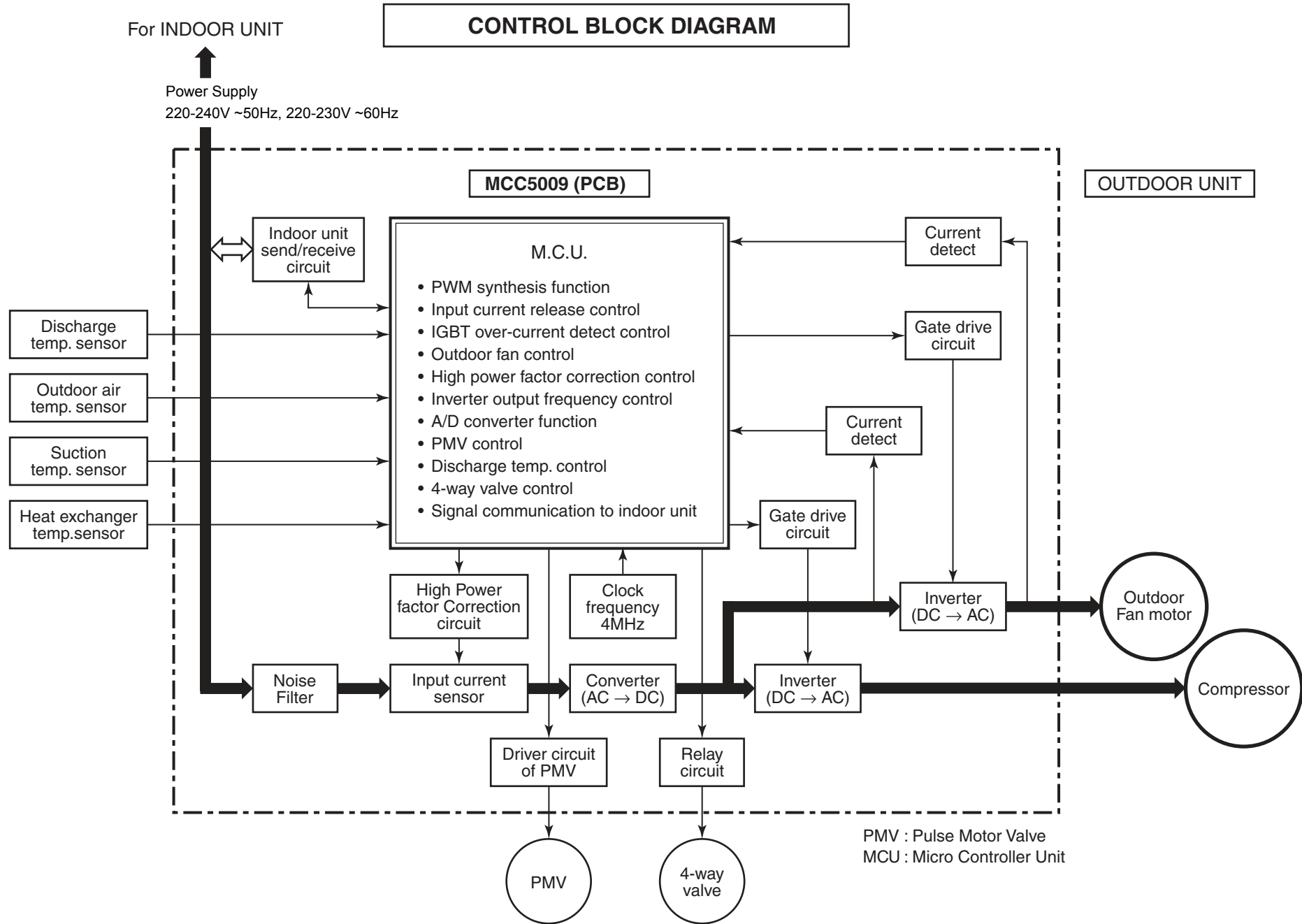

9. OPERATION DESCRIPTION

9-1. Outline of Air Conditioner Control

This air conditioner is a capacity-variable type air conditioner, which uses DC motor for the indoor fan motor and the outdoor fan motor. And the capacity-proportional control compressor which can change the motor speed in the range from 11 to 120 rps is mounted. The DC motor drive circuit is mounted to the indoor unit. The compressor and the inverter to control fan motor are mounted to the outdoor unit.

The entire air conditioner is mainly controlled by the indoor unit controller.

The indoor unit controller drives the indoor fan motor based upon command sent from the remote controller, and transfers the operation command to the outdoor unit controller.

The outdoor unit controller receives operation command from the indoor unit side, and controls the outdoor fan and the pulse motor valve. (PMV)

Besides, detecting revolution position of the compressor motor, the outdoor unit controller controls speed of the compressor motor by controlling output voltage of the inverter and switching timing of the supply power (current transfer timing) so that motors drive according to the operation command.

And then, the outdoor unit controller transfers reversely the operating status information of the outdoor unit to control the indoor unit controller.

As the compressor adopts four-pole brushless DC motor, the frequency of the supply power from inverter to compressor is two-times cycles of the actual number of revolution.

1. Role of indoor unit controller

The indoor unit controller judges the operation commands from the remote controller and assumes the following functions.

- Judgment of suction air temperature of the indoor heat exchanger by using the indoor temp. sensor. (TA sensor)
- Judgment of the indoor heat exchanger temperature by using heat exchanger sensor (TC sensor) (Prevent-freezing control, etc.)
- Louver motor control
- Indoor fan motor operation control
- LED (Light Emitting Diode) display control
- Transferring of operation command signal (Serial signal) to the outdoor unit
- Reception of information of operation status (Serial signal including outside temp. data) to the outdoor unit and judgment/display of error

2. Role of outdoor unit controller

Receiving the operation command signal (Serial signal) from the indoor unit controller, the outdoor unit performs its role.

- Compressor operation control
 - Operation control of outdoor fan motor
 - PMV control
 - 4-way valve control
- } Operations followed to judgment of serial signal from indoor side.

- Detection of inverter input current and current release operation
- Over-current detection and prevention operation to IGBT module (Compressor stop function)
- Compressor and outdoor fan stop function when serial signal is off (when the serial signal does not reach the board assembly of outdoor control by trouble of the signal system)
- Transferring of operation information (Serial signal) from outdoor unit controller to indoor unit controller
- Detection of outdoor temperature and operation revolution control
- Defrost control in heating operation (Temperature measurement by outdoor heat exchanger and control for 4-way valve and outdoor fan)

3. Contents of operation command signal (Serial signal) from indoor unit controller to outdoor unit controller

The following three types of signals are sent from the indoor unit controller.

- Operation mode set on the remote controller
- Compressor revolution command signal defined by indoor temperature and set temperature (Correction along with variation of room temperature and correction of indoor heat exchanger temperature are added.)
- Temperature of indoor heat exchanger
- For these signals ([Operation mode] and [Compressor revolution] indoor heat exchanger temperature), the outdoor unit controller monitors the input current to the inverter, and performs the followed operation within the range that current does not exceed the allowable value.

4. Contents of operation command signal (Serial signal) from outdoor unit controller to indoor unit controller

The following signals are sent from the outdoor unit controller.

- The current operation mode
 - The current compressor revolution
 - Outdoor temperature
 - Existence of protective circuit operation
- For transferring of these signals, the indoor unit controller monitors the contents of signals, and judges existence of trouble occurrence. Contents of judgment are described below.
- Whether distinction of the current operation status meets to the operation command signal
 - Whether protective circuit operates
- When no signal is received from the outdoor unit controller, it is assumed as a trouble.

9-2. Operation Description

1. Basic operation	26
1. Operation control	26
2. Cooling/Heating operation	27
3. AUTO operation	27
4. DRY operation	27
2. Indoor fan motor control	28
3. Outdoor fan motor control	30
4. Capacity control	31
5. Current release control	31
6. Release protective control by temperature of indoor heat exchanger	32
7. Defrost control (Only in heating operation)	33
8. Louver control	34
1) Louver position	34
2) Air direction adjustment	34
3) Swing	34
9. ECO operation	35
10. Temporary operation	36
11. Discharge temperature control	36
12. Pulse motor valve (PMV) control	37
13. Self-Cleaning function	38
14. Remote Controller-A or B selection	39
15. QUIET mode	40
16. COMFORT SLEEP	40
17. Short Timer	40
18. One Touch Comfort	41
19. Hi POWER Mode	41
20. FILTER Indicator	41

9-3. Auto Restart Function

9-3-1. How to Set the Auto Restart Function	42
9-3-2. How to Cancel the Auto Restart Function	43
9-3-3. Power Failure during Timer Operation	43

9-4. Remote Controller

9-4-1. Remote Controller and Its Functions	44
9-4-2. Operation of Remote Controller	44
9-4-3. Names and Functions of Indications on Remote Controller	47

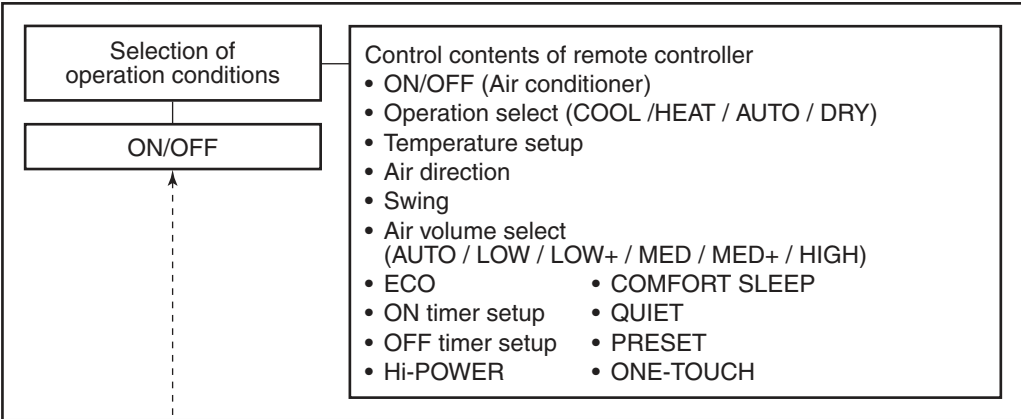
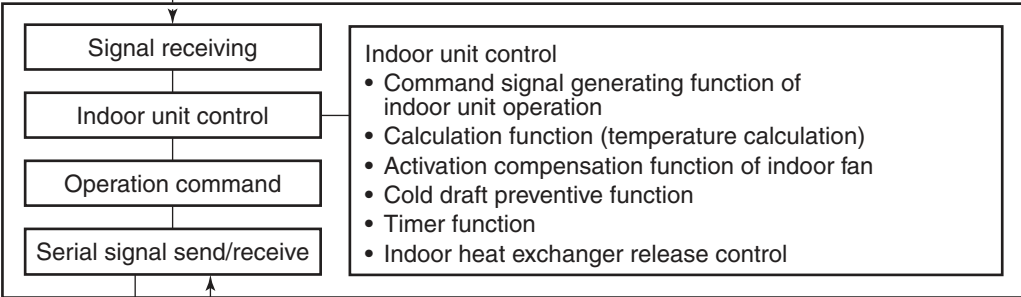
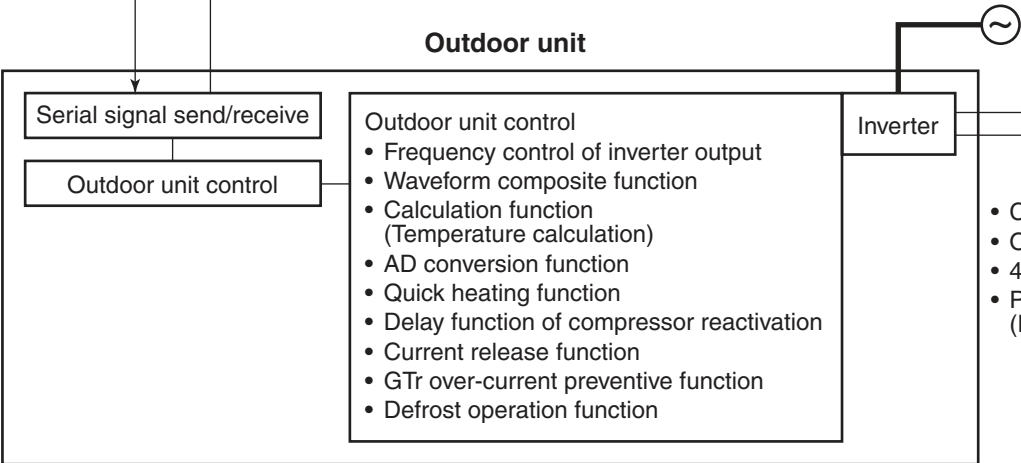
Item	Operation flow and applicable data, etc.	Description
<p>1. Basic operation</p>	<p>1. Operation control</p> <p>Receiving the user's operation condition setup, the operation statuses of indoor/outdoor units are controlled.</p> <ol style="list-style-type: none"> 1) The operation conditions are selected by the remote controller as shown in the below. 2) A signal is sent by ON button of the remote controller. 3) The signal is received by a sensor of the indoor unit and processed by the indoor controllers as shown in the below. 4) The indoor controller controls the indoor fan motor and louver motor. 5) The indoor controller sends the operation command to the outdoor controller, and sends/receives the control status with a serial signal. 6) The outdoor controller controls the operation as shown in the left, and also controls the compressor, outdoor fan motor, 4-way valve and pulse motor valve. <div style="text-align: center; margin-top: 20px;"> <p>Remote controller</p>  </div> <div style="text-align: center; margin-top: 20px;"> <p>Indoor unit</p>  </div> <div style="text-align: center; margin-top: 20px;"> <p>Outdoor unit</p>  </div>	

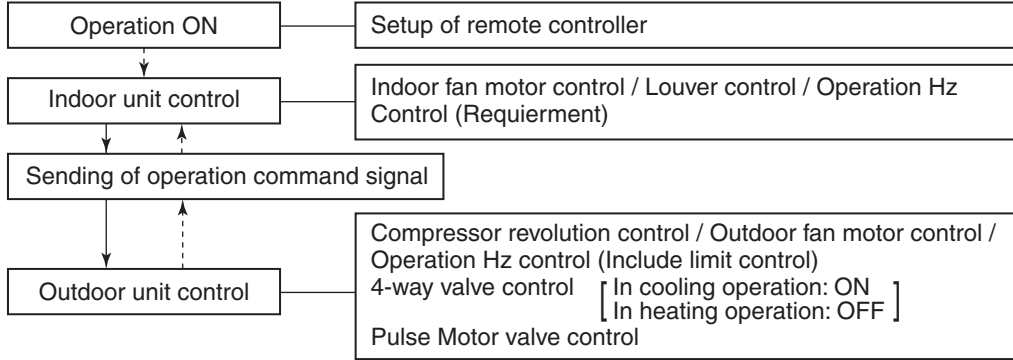
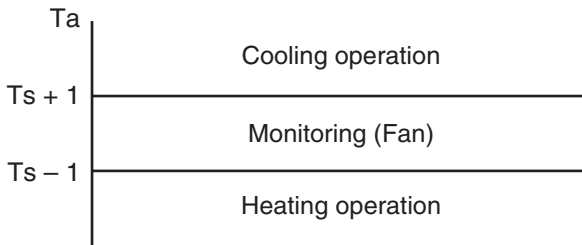
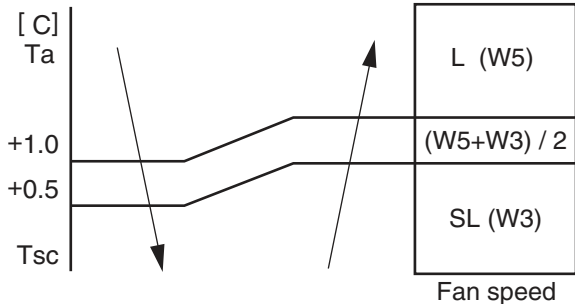
Item	Operation flow and applicable data, etc.	Description
<p>1. Basic operation</p>	<p>2. Cooling/Heating operation</p> <p>The operations are performed in the following parts by controls according to cooling/heating conditions.</p> <ol style="list-style-type: none"> 1) Receiving the operation ON signal of the remote controller, the cooling or heating operation signal starts being transferred from the indoor controller to the outdoor unit. 2) At the indoor unit side, the indoor fan is operated according to the contents of “2. Indoor fan motor control” and the louver according to the contents of “8. Louver control”, respectively. 3) The outdoor unit controls the outdoor fan motor, compressor, pulse motor valve and 4-way valve according to the operation signal sent from the indoor unit. 	
	<p>3. AUTO operation</p> <p>Selection of operation mode As shown in the following figure, the operation starts by selecting automatically the status of room temperature (Ta) when starting AUTO operation.</p> <p>*1. When reselecting the operation mode, the fan speed is controlled by the previous operation mode.</p> 	<ol style="list-style-type: none"> 1) Detects the room temperature (Ta) when the operation started. 2) Selects an operation mode from Ta in the left figure. 3) Fan operation continues until an operation mode is selected. 4) When AUTO operation has started within 2 hours after heating operation stopped and if the room temperature is 20°C or more, the fan operation is performed with “Super Ultra LOW” mode for 3 minutes. Then, select an operation mode. 5) If the status of compressor-OFF continues for 15 minutes the room temperature after selecting an operation mode (COOL/HEAT), reselect an operation mode.
	<p>4. DRY operation</p> <p>DRY operation is performed according to the difference between room temperature and the setup temperature as shown below.</p> <p>In DRY operation, fan speed is controlled in order to prevent lowering of the room temperature and to avoid air flow from blowing directly to persons.</p> 	<ol style="list-style-type: none"> 1) Detects the room temperature (Ta) when the DRY operation started. 2) Starts operation under conditions in the left figure according to the temperature difference between the room temperature and the setup temperature (Tsc). Setup temperature (Tsc) = Set temperature on remote controller (Ts) + (0.0 to 1.0) 3) When the room temperature is lower 1°C or less than the setup temperature, turn off the compressor.

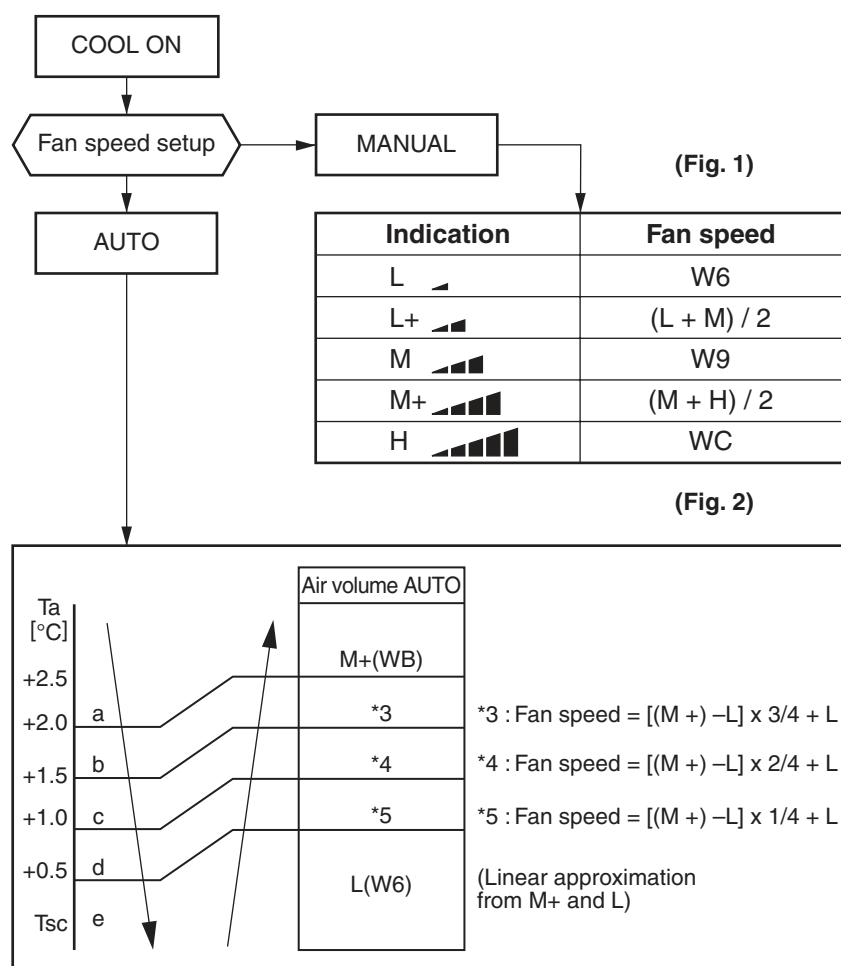
Item	Operation flow and applicable data, etc.	Description																																																																																																																																									
<p>2. Indoor fan motor control</p>	<p><In cooling operation> (This operation controls the fan speed at indoor unit side.) The indoor fan (cross flow fan) is operated by the phase-control induction motor. The fan rotates in 5 stages in MANUAL mode, and in 5 stages in AUTO mode, respectively. (Table 1)</p> 	<div style="border: 1px solid black; padding: 5px; margin-bottom: 10px;"> <p>* Symbols</p> <p>UH: Ultra High H : High M+: Medium+ M : Medium L+ : Low+ L : Low L- : Low- UL : Ultra Low SUL : Super Ultra Low</p> </div> <p>* The fan speed broadly varies due to position of the louver, etc. The described value indicates one under condition of inclining downward blowing.</p> <p>1) When setting the fan speed to L, L+, M, M+ or H on the remote controller, the operation is performed with the constant speed shown in Fig. 1.</p> <p>2) When setting the fan speed to AUTO on the remote controller, revolution of the fan motor is controlled to the fan speed level shown in Fig. 2 and Table 1 according to the setup temperature, room temperature, and heat exchanger temperature.</p>																																																																																																																																									
<p>(Table 1) Indoor fan air flow rate</p>																																																																																																																																											
<table border="1" style="width: 100%; border-collapse: collapse;"> <thead> <tr> <th rowspan="2">Fan speed level</th> <th rowspan="2">COOL</th> <th rowspan="2">HEAT</th> <th rowspan="2">DRY</th> <th colspan="2">RAS-18N3KV-E</th> <th colspan="2">RAS-22N3KV-E</th> </tr> <tr> <th>Fan speed (rpm)</th> <th>Air flow rate (m3/h)</th> <th>Fan speed (rpm)</th> <th>Air flow rate (m3/h)</th> </tr> </thead> <tbody> <tr><td>WF</td><td></td><td>UH</td><td></td><td>1100</td><td>990</td><td>1200</td><td>1100</td></tr> <tr><td>WE</td><td></td><td>H</td><td></td><td>1100</td><td>990</td><td>1200</td><td>1100</td></tr> <tr><td>WD</td><td></td><td>M+</td><td></td><td>1090</td><td>980</td><td>1200</td><td>1100</td></tr> <tr><td>WC</td><td>H</td><td></td><td></td><td>1070</td><td>957</td><td>1180</td><td>1080</td></tr> <tr><td>WB</td><td>M+</td><td>M</td><td></td><td>980</td><td>858</td><td>1080</td><td>968</td></tr> <tr><td>WA</td><td></td><td></td><td></td><td>940</td><td>813</td><td>1020</td><td>900</td></tr> <tr><td>W9</td><td>M</td><td>L+</td><td></td><td>890</td><td>758</td><td>980</td><td>858</td></tr> <tr><td>W8</td><td></td><td>L</td><td></td><td>780</td><td>636</td><td>850</td><td>713</td></tr> <tr><td>W7</td><td>L+</td><td>L-</td><td>L+</td><td>750</td><td>603</td><td>810</td><td>670</td></tr> <tr><td>W6</td><td>L</td><td></td><td>L</td><td>740</td><td>590</td><td>800</td><td>658</td></tr> <tr><td>W5</td><td>L-</td><td>UL</td><td>L-</td><td>700</td><td>547</td><td>760</td><td>614</td></tr> <tr><td>W4</td><td>UL</td><td></td><td>UL</td><td>700</td><td>547</td><td>700</td><td>547</td></tr> <tr><td>W3</td><td>SUL</td><td></td><td>SUL</td><td>650</td><td>492</td><td>650</td><td>492</td></tr> <tr><td>W2</td><td></td><td>SUL</td><td></td><td>500</td><td>325</td><td>500</td><td>325</td></tr> <tr><td>W1</td><td></td><td></td><td></td><td>500</td><td>325</td><td>500</td><td>325</td></tr> </tbody> </table>								Fan speed level	COOL	HEAT	DRY	RAS-18N3KV-E		RAS-22N3KV-E		Fan speed (rpm)	Air flow rate (m3/h)	Fan speed (rpm)	Air flow rate (m3/h)	WF		UH		1100	990	1200	1100	WE		H		1100	990	1200	1100	WD		M+		1090	980	1200	1100	WC	H			1070	957	1180	1080	WB	M+	M		980	858	1080	968	WA				940	813	1020	900	W9	M	L+		890	758	980	858	W8		L		780	636	850	713	W7	L+	L-	L+	750	603	810	670	W6	L		L	740	590	800	658	W5	L-	UL	L-	700	547	760	614	W4	UL		UL	700	547	700	547	W3	SUL		SUL	650	492	650	492	W2		SUL		500	325	500	325	W1				500	325	500	325
Fan speed level	COOL	HEAT	DRY	RAS-18N3KV-E		RAS-22N3KV-E																																																																																																																																					
				Fan speed (rpm)	Air flow rate (m3/h)	Fan speed (rpm)	Air flow rate (m3/h)																																																																																																																																				
WF		UH		1100	990	1200	1100																																																																																																																																				
WE		H		1100	990	1200	1100																																																																																																																																				
WD		M+		1090	980	1200	1100																																																																																																																																				
WC	H			1070	957	1180	1080																																																																																																																																				
WB	M+	M		980	858	1080	968																																																																																																																																				
WA				940	813	1020	900																																																																																																																																				
W9	M	L+		890	758	980	858																																																																																																																																				
W8		L		780	636	850	713																																																																																																																																				
W7	L+	L-	L+	750	603	810	670																																																																																																																																				
W6	L		L	740	590	800	658																																																																																																																																				
W5	L-	UL	L-	700	547	760	614																																																																																																																																				
W4	UL		UL	700	547	700	547																																																																																																																																				
W3	SUL		SUL	650	492	650	492																																																																																																																																				
W2		SUL		500	325	500	325																																																																																																																																				
W1				500	325	500	325																																																																																																																																				

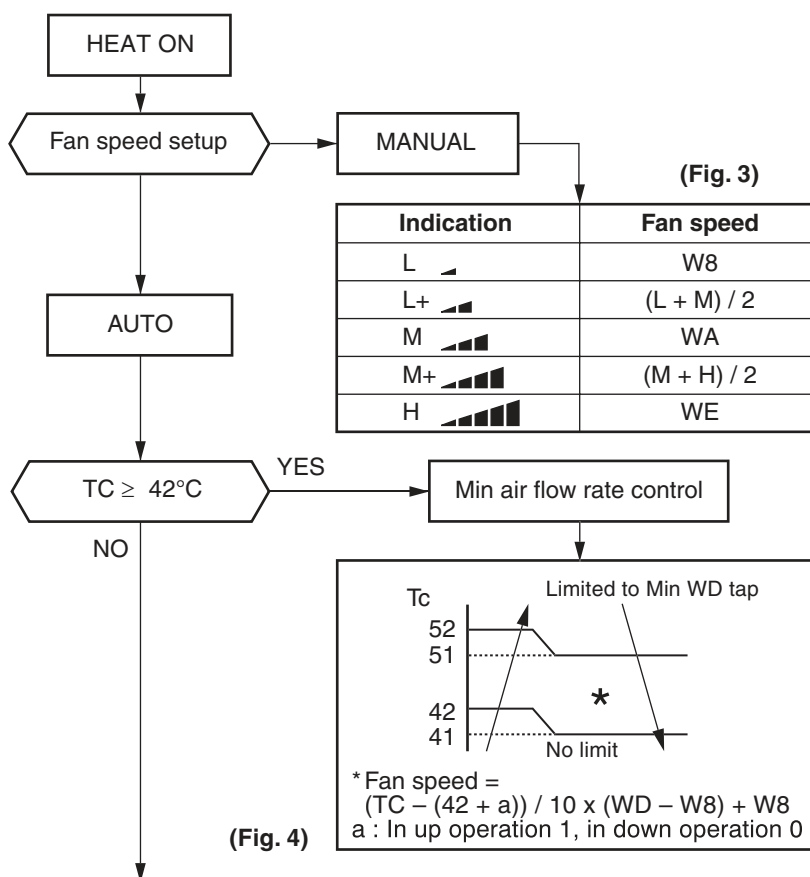
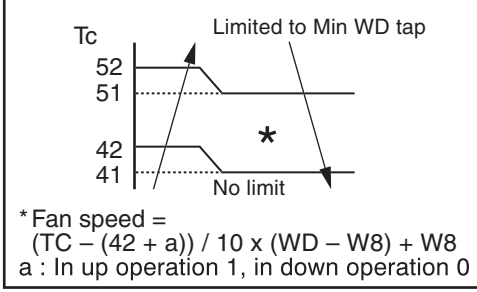
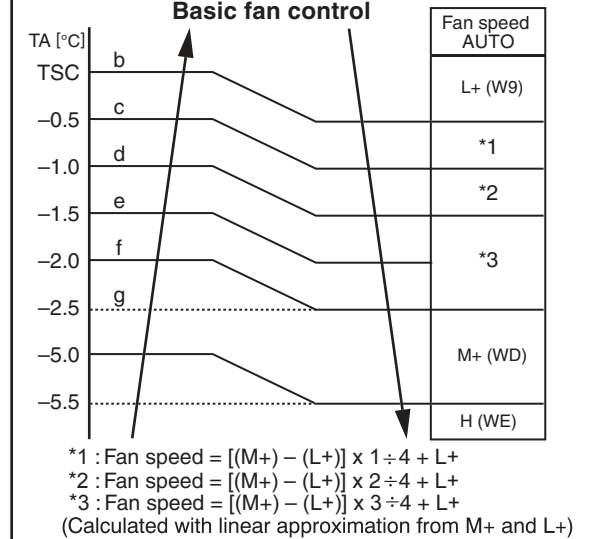
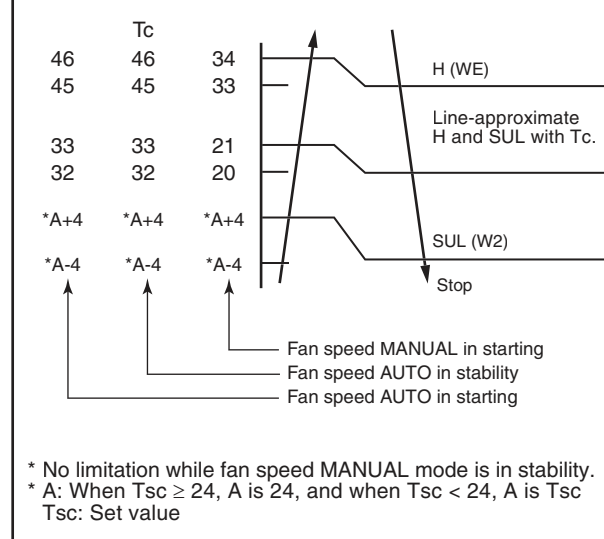



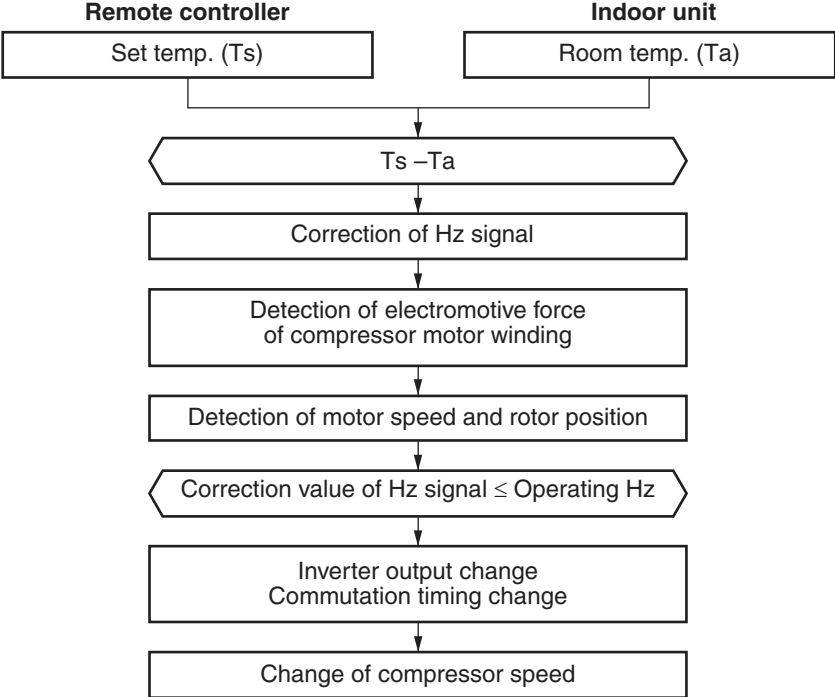
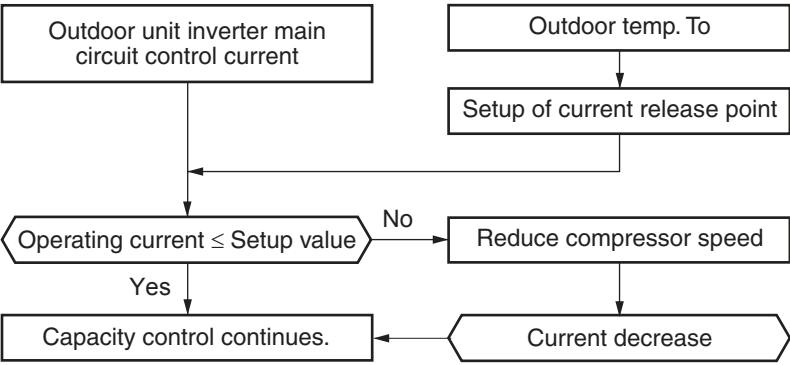

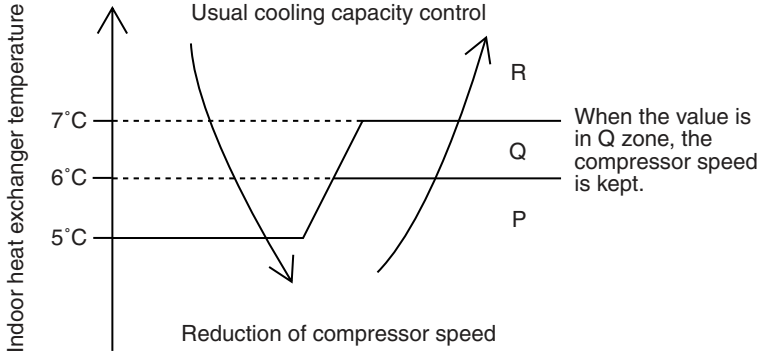
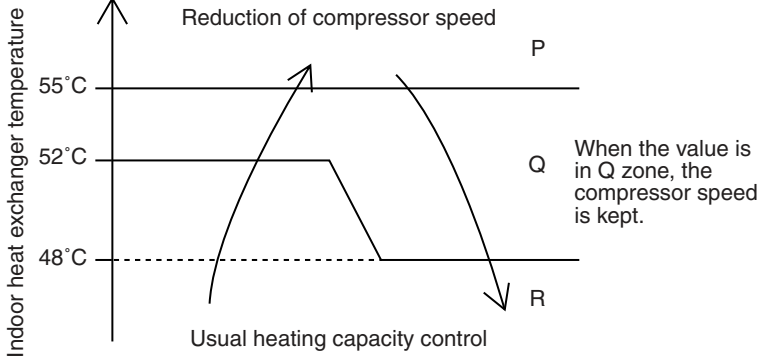

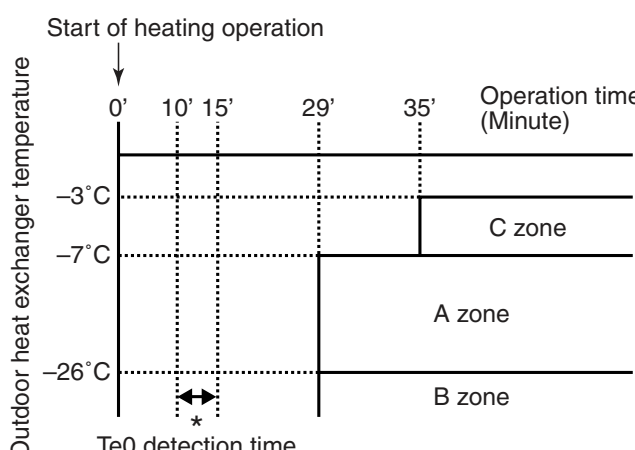

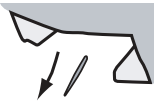





Item	Operation flow and applicable data, etc.	Description												
<p>2. Indoor fan motor control</p> 	<p><In heating operation></p> <p>(Fig. 3)</p> <table border="1" data-bbox="494 492 973 716"> <thead> <tr> <th>Indication</th> <th>Fan speed</th> </tr> </thead> <tbody> <tr> <td>L </td> <td>W8</td> </tr> <tr> <td>L+ </td> <td>(L + M) / 2</td> </tr> <tr> <td>M </td> <td>WA</td> </tr> <tr> <td>M+ </td> <td>(M + H) / 2</td> </tr> <tr> <td>H </td> <td>WE</td> </tr> </tbody> </table> <p>(Fig. 4)</p>  <p>* Fan speed = $(TC - (42 + a)) / 10 \times (WD - W8) + W8$ a : In up operation 1, in down operation 0</p>	Indication	Fan speed	L	W8	L+	(L + M) / 2	M	WA	M+	(M + H) / 2	H	WE	<ol style="list-style-type: none"> 1) When setting the fan speed to L, L+, M, M+ or H on the remote controller, the operation is performed with the constant speed shown in Fig. 3 and Table 1. 2) When setting the fan speed to AUTO on the remote controller, revolution of the fan motor is controlled to the fan speed level shown in Fig. 5 according to the set temperature and room temperature. 3) Min air flow rate is controlled by temperature of the indoor heat exchanger (Tc) as shown in Fig. 4. 4) Cold draft prevention, the fan speed is controlled by temperature of the indoor heat exchanger (Tc) as shown in Fig. 6. 5) In order to prevent Cold draft when compressor stop during heating operation. Then louver will move to upper position and fan speed will reduce or off.
Indication	Fan speed													
L	W8													
L+	(L + M) / 2													
M	WA													
M+	(M + H) / 2													
H	WE													
	<p>(Fig. 5)</p>  <p>*1 : Fan speed = $[(M+) - (L+)] \times 1 \div 4 + L+$ *2 : Fan speed = $[(M+) - (L+)] \times 2 \div 4 + L+$ *3 : Fan speed = $[(M+) - (L+)] \times 3 \div 4 + L+$ (Calculated with linear approximation from M+ and L+)</p>	<p>(Fig. 6)</p>  <p>* No limitation while fan speed MANUAL mode is in stability. * A: When Tsc ≥ 24, A is 24, and when Tsc < 24, A is Tsc Tsc: Set value</p>												
<p>[In starting and in stability]</p>	<table border="1" data-bbox="159 1859 1420 2060"> <thead> <tr> <th></th> <th>In starting</th> <th>In stability</th> </tr> </thead> <tbody> <tr> <td>FAN AUTO</td> <td> <ul style="list-style-type: none"> • Until 12 minutes passed after operation start • When 12 to 25 minutes passed after operation start and room temp. is 3°C or lower than set temp. </td> <td> <ul style="list-style-type: none"> • When 12 to 25 minutes passed after operation start and room temp. is higher than (set temp. -3°C) • When 25 minutes or more passed after operation start </td> </tr> <tr> <td>FAN Manual</td> <td> <ul style="list-style-type: none"> • Room temp. < Set temp. -4°C </td> <td> <ul style="list-style-type: none"> • Room temp. ≥ Set temp. -3.5°C </td> </tr> </tbody> </table>		In starting	In stability	FAN AUTO	<ul style="list-style-type: none"> • Until 12 minutes passed after operation start • When 12 to 25 minutes passed after operation start and room temp. is 3°C or lower than set temp. 	<ul style="list-style-type: none"> • When 12 to 25 minutes passed after operation start and room temp. is higher than (set temp. -3°C) • When 25 minutes or more passed after operation start 	FAN Manual	<ul style="list-style-type: none"> • Room temp. < Set temp. -4°C 	<ul style="list-style-type: none"> • Room temp. ≥ Set temp. -3.5°C 				
	In starting	In stability												
FAN AUTO	<ul style="list-style-type: none"> • Until 12 minutes passed after operation start • When 12 to 25 minutes passed after operation start and room temp. is 3°C or lower than set temp. 	<ul style="list-style-type: none"> • When 12 to 25 minutes passed after operation start and room temp. is higher than (set temp. -3°C) • When 25 minutes or more passed after operation start 												
FAN Manual	<ul style="list-style-type: none"> • Room temp. < Set temp. -4°C 	<ul style="list-style-type: none"> • Room temp. ≥ Set temp. -3.5°C 												

Item	Operation flow and applicable data, etc.	Description																																																																																																																																																																																																																																				
<p>3. Outdoor fan motor control</p>	<p>The blowing air volume at the outdoor unit side is controlled. Receiving the operation command from the controller of indoor unit, the controller of outdoor unit controls fan speed.</p> <p>* For the fan motor, a DC motor with non-stage variable speed system is used. However, it is limited to 8 stages for reasons of controlling.</p> <pre> graph TD A[Air conditioner ON (Remote controller)] --> B[Indoor unit controller] B --> C[1) Outdoor unit operation command (Outdoor fan control)] C --> D{2) Fan speed >= 400 when the motor stopped.} D -- YES --> E[OFF status of fan motor continues.] D -- NO --> F[Fan motor ON] F --> G{3) Fan lock} G -- YES --> H[Air conditioner OFF] H --> I[Alarm display] G -- NO --> J[4) Motor operates as shown in the table below.] J --> K[In cooling operation table] J --> L[In Heating operation table] </pre> <p>In cooling operation</p> <table border="1"> <thead> <tr> <th colspan="2" rowspan="2"></th> <th colspan="2">< 22.1</th> <th colspan="2">< 50.3</th> <th colspan="2">50.3 ≤</th> </tr> <tr> <th>MIN</th> <th>MAX</th> <th>MIN</th> <th>MAX</th> <th>MIN</th> <th>MAX</th> </tr> </thead> <tbody> <tr> <td rowspan="6">To</td> <td>To ≥ 38°C</td> <td>f 6</td> <td>f 9</td> <td>f 8</td> <td>f B</td> <td>f A</td> <td>f E</td> </tr> <tr> <td>To ≥ 28°C</td> <td>f 5</td> <td>f 9</td> <td>f 7</td> <td>f B</td> <td>f 9</td> <td>f E</td> </tr> <tr> <td>To ≥ 15°C</td> <td>f 3</td> <td>f 7</td> <td>f 5</td> <td>f 9</td> <td>f 7</td> <td>f B</td> </tr> <tr> <td>To ≥ 5.5°C</td> <td>f 1</td> <td>f 3</td> <td>f 1</td> <td>f 7</td> <td>f 3</td> <td>f 9</td> </tr> <tr> <td>To ≥ 0°C</td> <td>f 1</td> <td>f 3</td> <td>f 1</td> <td>f 5</td> <td>f 3</td> <td>f 7</td> </tr> <tr> <td>To ≥ -5°C</td> <td>f 0</td> <td>f 1</td> <td>f 0</td> <td>f 3</td> <td>f 1</td> <td>f 4</td> </tr> <tr> <td rowspan="5">During ECO, QUIET and comfort sleep</td> <td>To ≥ 38°C</td> <td>f 6</td> <td>f 9</td> <td>f 8</td> <td>f B</td> <td>f A</td> <td>f B</td> </tr> <tr> <td>To ≥ 28°C</td> <td>f 5</td> <td>f 9</td> <td>f 7</td> <td>f B</td> <td>f 9</td> <td>f B</td> </tr> <tr> <td>To ≥ 15°C</td> <td>f 3</td> <td>f 7</td> <td>f 5</td> <td>f 9</td> <td>f 7</td> <td>f B</td> </tr> <tr> <td>To ≥ 5.5°C</td> <td>f 1</td> <td>f 3</td> <td>f 1</td> <td>f 7</td> <td>f 3</td> <td>f 9</td> </tr> <tr> <td>To ≥ 0°C</td> <td>f 1</td> <td>f 3</td> <td>f 1</td> <td>f 5</td> <td>f 3</td> <td>f 7</td> </tr> <tr> <td colspan="2">When To is abnormal</td> <td>f 1</td> <td>f F</td> <td>f 1</td> <td>f F</td> <td>f 1</td> <td>f F</td> </tr> </tbody> </table> <p>In Heating operation</p> <table border="1"> <thead> <tr> <th colspan="2" rowspan="2"></th> <th colspan="2">< 30.5</th> <th colspan="2">< 55.1</th> <th colspan="2">55.1 ≤</th> </tr> <tr> <th>MIN</th> <th>MAX</th> <th>MIN</th> <th>MAX</th> <th>MIN</th> <th>MAX</th> </tr> </thead> <tbody> <tr> <td rowspan="4">To</td> <td>To ≥ 10°C</td> <td>f 6</td> <td>f 8</td> <td>f 8</td> <td>f 9</td> <td>f 9</td> <td>f 9</td> </tr> <tr> <td>To ≥ 5.5°C</td> <td>f 8</td> <td>f 8</td> <td>f A</td> <td>f C</td> <td>f C</td> <td>f C</td> </tr> <tr> <td>To ≥ -5°C</td> <td>f A</td> <td>f A</td> <td>f B</td> <td>f D</td> <td>f D</td> <td>f D</td> </tr> <tr> <td>To < -5°C</td> <td>f A</td> <td>f A</td> <td>f B</td> <td>f D</td> <td>f D</td> <td>f D</td> </tr> <tr> <td rowspan="3">During ECO mode</td> <td>To ≥ 10°C</td> <td>f 5</td> <td>f 7</td> <td>f 7</td> <td>f 9</td> <td>f 9</td> <td>f 9</td> </tr> <tr> <td>To ≥ 5.5°C</td> <td>f 7</td> <td>f 7</td> <td>f 9</td> <td>f B</td> <td>f B</td> <td>f B</td> </tr> <tr> <td>To ≥ -5°C</td> <td>f 9</td> <td>f 9</td> <td>f A</td> <td>f B</td> <td>f B</td> <td>f B</td> </tr> <tr> <td colspan="2">When To is abnormal</td> <td>f D</td> <td>f D</td> <td>f D</td> <td>f D</td> <td>f D</td> <td>f D</td> </tr> </tbody> </table> <p>Outdoor fan speed (rpm)</p> <table border="1"> <thead> <tr> <th>Tab</th> <th>RAS-18N3AV-E</th> <th>RAS-22N3AV-E</th> </tr> </thead> <tbody> <tr><td>f 0</td><td>0</td><td>0</td></tr> <tr><td>f 1</td><td>230</td><td>230</td></tr> <tr><td>f 2</td><td>300</td><td>300</td></tr> <tr><td>f 3</td><td>350</td><td>350</td></tr> <tr><td>f 4</td><td>410</td><td>410</td></tr> <tr><td>f 5</td><td>480</td><td>480</td></tr> <tr><td>f 6</td><td>500</td><td>500</td></tr> <tr><td>f 7</td><td>530</td><td>530</td></tr> </tbody> </table> <table border="1"> <thead> <tr> <th>Tab</th> <th>RAS-18N3AV-E</th> <th>RAS-22N3AV-E</th> </tr> </thead> <tbody> <tr><td>f 8</td><td>560</td><td>560</td></tr> <tr><td>f 9</td><td>640</td><td>640</td></tr> <tr><td>f A</td><td>670</td><td>670</td></tr> <tr><td>f B</td><td>700</td><td>750</td></tr> <tr><td>f C</td><td>800</td><td>920</td></tr> <tr><td>f D</td><td>800</td><td>920</td></tr> <tr><td>f E</td><td>900</td><td>1000</td></tr> <tr><td>f F</td><td>900</td><td>1000</td></tr> </tbody> </table>			< 22.1		< 50.3		50.3 ≤		MIN	MAX	MIN	MAX	MIN	MAX	To	To ≥ 38°C	f 6	f 9	f 8	f B	f A	f E	To ≥ 28°C	f 5	f 9	f 7	f B	f 9	f E	To ≥ 15°C	f 3	f 7	f 5	f 9	f 7	f B	To ≥ 5.5°C	f 1	f 3	f 1	f 7	f 3	f 9	To ≥ 0°C	f 1	f 3	f 1	f 5	f 3	f 7	To ≥ -5°C	f 0	f 1	f 0	f 3	f 1	f 4	During ECO, QUIET and comfort sleep	To ≥ 38°C	f 6	f 9	f 8	f B	f A	f B	To ≥ 28°C	f 5	f 9	f 7	f B	f 9	f B	To ≥ 15°C	f 3	f 7	f 5	f 9	f 7	f B	To ≥ 5.5°C	f 1	f 3	f 1	f 7	f 3	f 9	To ≥ 0°C	f 1	f 3	f 1	f 5	f 3	f 7	When To is abnormal		f 1	f F	f 1	f F	f 1	f F			< 30.5		< 55.1		55.1 ≤		MIN	MAX	MIN	MAX	MIN	MAX	To	To ≥ 10°C	f 6	f 8	f 8	f 9	f 9	f 9	To ≥ 5.5°C	f 8	f 8	f A	f C	f C	f C	To ≥ -5°C	f A	f A	f B	f D	f D	f D	To < -5°C	f A	f A	f B	f D	f D	f D	During ECO mode	To ≥ 10°C	f 5	f 7	f 7	f 9	f 9	f 9	To ≥ 5.5°C	f 7	f 7	f 9	f B	f B	f B	To ≥ -5°C	f 9	f 9	f A	f B	f B	f B	When To is abnormal		f D	f D	f D	f D	f D	f D	Tab	RAS-18N3AV-E	RAS-22N3AV-E	f 0	0	0	f 1	230	230	f 2	300	300	f 3	350	350	f 4	410	410	f 5	480	480	f 6	500	500	f 7	530	530	Tab	RAS-18N3AV-E	RAS-22N3AV-E	f 8	560	560	f 9	640	640	f A	670	670	f B	700	750	f C	800	920	f D	800	920	f E	900	1000	f F	900	1000	<ol style="list-style-type: none"> The operation command sent from the remote controller is processed by the indoor unit controller and transferred to the controller of the outdoor unit. When strong wind blows at outdoor side, the operation of air conditioner continues with the fan motor stopped. Whether the fan is locked or not is detected, and the operation of air conditioner stops and an alarm is displayed if the fan is locked. According to each operation mode, by the conditions of outdoor temperature (To) and compressor revolution, the speed of the outdoor fan shown in the table is selected.
				< 22.1		< 50.3		50.3 ≤																																																																																																																																																																																																																														
		MIN	MAX	MIN	MAX	MIN	MAX																																																																																																																																																																																																																															
To	To ≥ 38°C	f 6	f 9	f 8	f B	f A	f E																																																																																																																																																																																																																															
	To ≥ 28°C	f 5	f 9	f 7	f B	f 9	f E																																																																																																																																																																																																																															
	To ≥ 15°C	f 3	f 7	f 5	f 9	f 7	f B																																																																																																																																																																																																																															
	To ≥ 5.5°C	f 1	f 3	f 1	f 7	f 3	f 9																																																																																																																																																																																																																															
	To ≥ 0°C	f 1	f 3	f 1	f 5	f 3	f 7																																																																																																																																																																																																																															
	To ≥ -5°C	f 0	f 1	f 0	f 3	f 1	f 4																																																																																																																																																																																																																															
During ECO, QUIET and comfort sleep	To ≥ 38°C	f 6	f 9	f 8	f B	f A	f B																																																																																																																																																																																																																															
	To ≥ 28°C	f 5	f 9	f 7	f B	f 9	f B																																																																																																																																																																																																																															
	To ≥ 15°C	f 3	f 7	f 5	f 9	f 7	f B																																																																																																																																																																																																																															
	To ≥ 5.5°C	f 1	f 3	f 1	f 7	f 3	f 9																																																																																																																																																																																																																															
	To ≥ 0°C	f 1	f 3	f 1	f 5	f 3	f 7																																																																																																																																																																																																																															
When To is abnormal		f 1	f F	f 1	f F	f 1	f F																																																																																																																																																																																																																															
		< 30.5		< 55.1		55.1 ≤																																																																																																																																																																																																																																
		MIN	MAX	MIN	MAX	MIN	MAX																																																																																																																																																																																																																															
To	To ≥ 10°C	f 6	f 8	f 8	f 9	f 9	f 9																																																																																																																																																																																																																															
	To ≥ 5.5°C	f 8	f 8	f A	f C	f C	f C																																																																																																																																																																																																																															
	To ≥ -5°C	f A	f A	f B	f D	f D	f D																																																																																																																																																																																																																															
	To < -5°C	f A	f A	f B	f D	f D	f D																																																																																																																																																																																																																															
During ECO mode	To ≥ 10°C	f 5	f 7	f 7	f 9	f 9	f 9																																																																																																																																																																																																																															
	To ≥ 5.5°C	f 7	f 7	f 9	f B	f B	f B																																																																																																																																																																																																																															
	To ≥ -5°C	f 9	f 9	f A	f B	f B	f B																																																																																																																																																																																																																															
When To is abnormal		f D	f D	f D	f D	f D	f D																																																																																																																																																																																																																															
Tab	RAS-18N3AV-E	RAS-22N3AV-E																																																																																																																																																																																																																																				
f 0	0	0																																																																																																																																																																																																																																				
f 1	230	230																																																																																																																																																																																																																																				
f 2	300	300																																																																																																																																																																																																																																				
f 3	350	350																																																																																																																																																																																																																																				
f 4	410	410																																																																																																																																																																																																																																				
f 5	480	480																																																																																																																																																																																																																																				
f 6	500	500																																																																																																																																																																																																																																				
f 7	530	530																																																																																																																																																																																																																																				
Tab	RAS-18N3AV-E	RAS-22N3AV-E																																																																																																																																																																																																																																				
f 8	560	560																																																																																																																																																																																																																																				
f 9	640	640																																																																																																																																																																																																																																				
f A	670	670																																																																																																																																																																																																																																				
f B	700	750																																																																																																																																																																																																																																				
f C	800	920																																																																																																																																																																																																																																				
f D	800	920																																																																																																																																																																																																																																				
f E	900	1000																																																																																																																																																																																																																																				
f F	900	1000																																																																																																																																																																																																																																				

Item	Operation flow and applicable data, etc.	Description																																			
<p>4. Capacity control</p>	<p>The cooling or heating capacity depending on the load is adjusted.</p> <p>According to difference between the setup value of temperature and the room temperature, the capacity is adjusted by the compressor revolution.</p> 	<ol style="list-style-type: none"> 1) The difference between set temperature on remote controller (Ts) and room temperature (Ta) is calculated. 2) According to the temperature difference, the correction value of Hz signal which determines the compressor speed is set up. 3) The rotating position and speed of the motor are detected by the electromotive force occurred on the motor winding with operation of the compressor. 4) According to the difference resulted from comparison of the correction value of Hz signal with the present operation Hz, the inverter output and the commutation timing are varied. 5) Change the compressor motor speed by outputting power to the compressor. <p>* The contents of control operation are same in cooling operation and heating operation</p>																																			
<p>5. Current release control</p>	<p>This function prevents troubles on the electronic parts of the compressor driving inverter.</p> <p>This function also controls drive circuit of the compressor speed so that electric power of the compressor drive circuit does not exceed the specified value.</p>  <table border="1" data-bbox="172 1729 995 2027"> <thead> <tr> <th rowspan="2">Outdoor temp.</th> <th colspan="2">Cooling current release value</th> <th colspan="2">Heating current release value</th> </tr> <tr> <th>RAS-18N3AV-E</th> <th>RAS-22N3AV-E</th> <th>RAS-18N3AV-E</th> <th>RAS-22N3AV-E</th> </tr> </thead> <tbody> <tr> <td>45°C</td> <td>4.88A</td> <td>7.05A</td> <td rowspan="3">8.77A</td> <td rowspan="3">10.88A</td> </tr> <tr> <td>40°C</td> <td>6.15A</td> <td>9.30A</td> </tr> <tr> <td>16°C</td> <td>8.02A</td> <td>10.50A</td> </tr> <tr> <td>11°C</td> <td></td> <td></td> <td></td> <td></td> </tr> <tr> <td></td> <td></td> <td></td> <td></td> <td></td> </tr> <tr> <td></td> <td></td> <td></td> <td></td> <td></td> </tr> </tbody> </table>	Outdoor temp.	Cooling current release value		Heating current release value		RAS-18N3AV-E	RAS-22N3AV-E	RAS-18N3AV-E	RAS-22N3AV-E	45°C	4.88A	7.05A	8.77A	10.88A	40°C	6.15A	9.30A	16°C	8.02A	10.50A	11°C															<ol style="list-style-type: none"> 1) The input current of the outdoor unit is detected in the inverter section of the outdoor unit. 2) According to the detected outdoor temperature, the specified value of the current is selected. 3) Whether the current value exceeds the specified value or not is judged. 4) If the current value exceeds the specified value, this function reduces the compressor speed and controls speed up to the closest one commanded from the indoor unit within the range which does not exceed the specified value.
Outdoor temp.	Cooling current release value		Heating current release value																																		
	RAS-18N3AV-E	RAS-22N3AV-E	RAS-18N3AV-E	RAS-22N3AV-E																																	
45°C	4.88A	7.05A	8.77A	10.88A																																	
40°C	6.15A	9.30A																																			
16°C	8.02A	10.50A																																			
11°C																																					

Item	Operation flow and applicable data, etc.	Description
<p>6. Release protective control by temperature of indoor heat exchanger</p>	<p><In cooling/dry operation> (Prevent-freezing control for indoor heat exchanger) In cooling/dry operation, the sensor of indoor heat exchanger detects evaporation temperature and controls the compressor speed so that temperature of the heat exchanger does not exceed the specified value.</p>  <p><In heating operation> (Prevent-overpressure control for refrigerating cycle) In heating operation, the sensor of indoor heat exchanger detects condensation temperature and controls the compressor speed so that temperature of the heat exchanger does not exceed the specified value.</p> 	<p>1) When temperature of the indoor heat exchanger drops below 5°C, the compressor speed is reduced. (P zone)</p> <p>2) When temperature of the indoor heat exchanger rises in the range from 6°C to under 7°C, the compressor speed is kept. (Q zone)</p> <p>3) When temperature of the indoor heat exchanger rises to 7°C or higher, the capacity control operation returns to the usual control in cooling operation. (R zone)</p> <p>1) When temperature of the indoor heat exchanger rises in the range from 52°C to 55°C, the compressor speed is kept. (Q zone)</p> <p>2) When temperature of the indoor heat exchanger rises to 55°C or higher, the compressor speed is reduced. (P zone)</p> <p>3) When temperature of the indoor heat exchanger drops in the range from 55°C to under 48°C, the compressor speed is kept. (Q zone)</p> <p>4) When temperature of the indoor heat exchanger does not rise to 52°C, or when it drops below to 48°C, the capacity control operation returns to the usual control in heating operation. (R zone)</p>

Item	Operation flow and applicable data, etc.	Description								
<p>7. Defrost control (Only in heating operation)</p>	<p>(This function removes frost adhered to the outdoor heat exchanger.)</p> <p>The temperature sensor of the outdoor heat exchanger (Te sensor) judges the frosting status of the outdoor heat exchanger and the defrost operation is performed with 4-way valve reverse defrost system.</p>  <p>* The minimum value of Te sensor 10 to 15 minutes after start of operation is stored in memory as Te0.</p> <p style="text-align: center;">Table 1</p> <table border="1" data-bbox="167 1075 933 1288"> <thead> <tr> <th>Zone</th> <th>Condition</th> </tr> </thead> <tbody> <tr> <td>A zone</td> <td>When $Te_0 - TE \geq 2.5$ continued for 2 minutes in A zone, defrost operation starts.</td> </tr> <tr> <td>B zone</td> <td>When the operation continued for 2 minutes in B zone, defrost operation starts.</td> </tr> <tr> <td>C zone</td> <td>When $Te_0 - TE \geq 3$ continued for 2 minutes in C zone, defrost operation starts.</td> </tr> </tbody> </table>	Zone	Condition	A zone	When $Te_0 - TE \geq 2.5$ continued for 2 minutes in A zone, defrost operation starts.	B zone	When the operation continued for 2 minutes in B zone, defrost operation starts.	C zone	When $Te_0 - TE \geq 3$ continued for 2 minutes in C zone, defrost operation starts.	<p>The necessity of defrost operation is detected by the outdoor heat exchanger temperature. The conditions to detect the necessity of defrost operation differ in A, B, or C zone each. (Table 1)</p> <p><Defrost operation></p> <ul style="list-style-type: none"> Defrost operation in A to C zones <ol style="list-style-type: none"> 1) Stop operation of the compressor for 20 seconds. 2) Invert (ON) 4-way valve 10 seconds after stop of the compressor. 3) The outdoor fan stops at the same time when the compressor stops. 4) When temperature of the indoor heat exchanger becomes 38°C or lower, stop the indoor fan. <p><Finish of defrost operation></p> <ul style="list-style-type: none"> Returning conditions from defrost operation to heating operation <ol style="list-style-type: none"> 1) Temperature of outdoor heat exchanger rises to +8°C or higher. 2) Temperature of outdoor heat exchanger is kept at +5°C or higher for 80 seconds. 3) Defrost operation continues for 15 minutes. <p><Returning from defrost operation></p> <ol style="list-style-type: none"> 1) Stop operation of the compressor for approx. 50 seconds. 2) Invert (OFF) 4-way valve approx. 40 seconds after stop of the compressor. 3) The outdoor fan starts rotating at the same time when the compressor starts.
Zone	Condition									
A zone	When $Te_0 - TE \geq 2.5$ continued for 2 minutes in A zone, defrost operation starts.									
B zone	When the operation continued for 2 minutes in B zone, defrost operation starts.									
C zone	When $Te_0 - TE \geq 3$ continued for 2 minutes in C zone, defrost operation starts.									

Item	Operation flow and applicable data, etc.	Description									
<p>8. Louver control</p> <p>1) Louver position</p> <p>2) Air direction adjustment</p> <p>3) Swing</p>	<p>This function controls the air direction of the indoor unit.</p> <ul style="list-style-type: none"> The position is automatically controlled according to the operation mode (COOL/HEAT). The set louver position is stored in memory by the microcomputer, and the louver returns to the stored position when the next operation is performed. (Cooling/heating memory position) <p>The angle of the louver is indicated as the horizontal angle is 0°.</p> <p>1) Louver position in cooling operation</p> <div data-bbox="427 544 847 801" style="border: 1px solid black; padding: 5px; margin-bottom: 10px;"> <p style="text-align: center;">Cooling operation/ AUTO (COOL)</p>  <p style="font-size: small;">Initial setting of "Cooling storage position" Louver : Horizontal blowing (37.4°)</p> </div> <p>2) Louver position in heating operation</p> <div data-bbox="434 913 853 1198" style="border: 1px solid black; padding: 5px; margin-bottom: 10px;"> <p style="text-align: center;">Heating operation/ AUTO (HEAT)</p>  <p style="font-size: small;">Initial setting of "Heating storage position" Louver : Directs downward (76.9°)</p> </div> <p>Air direction adjustment</p> <div data-bbox="167 1310 1109 1585" style="border: 1px solid black; padding: 5px; margin-bottom: 10px;"> <p style="text-align: center; border: 1px solid black; display: inline-block; padding: 2px;">Air direction</p></div> <table border="1" style="width: 100%; text-align: center; font-size: small;"> <tr> <td>Horizontal blowing</td> <td>Inclined blowing</td> <td>Blowing downward</td> <td>Inclined blowing</td> <td>Horizontal blowing</td> </tr> <tr> <td></td> <td></td> <td></td> <td></td> <td></td> </tr> </table>	Horizontal blowing	Inclined blowing	Blowing downward	Inclined blowing	Horizontal blowing					
Horizontal blowing	Inclined blowing	Blowing downward	Inclined blowing	Horizontal blowing							
											

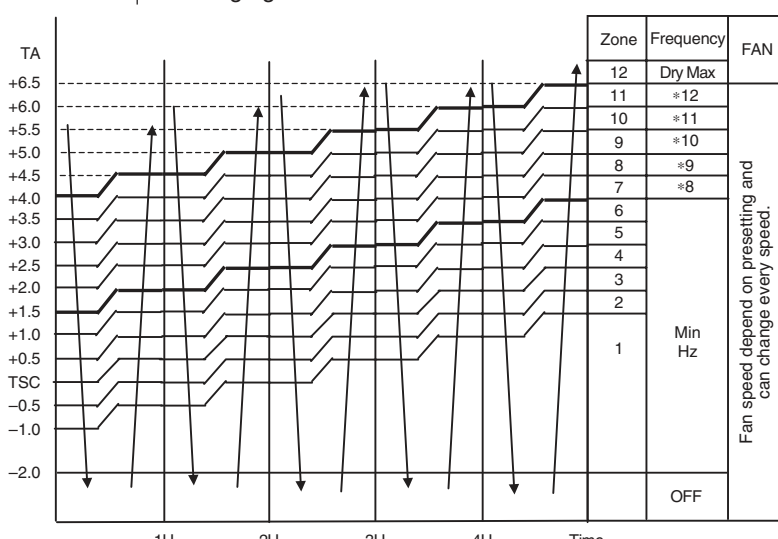
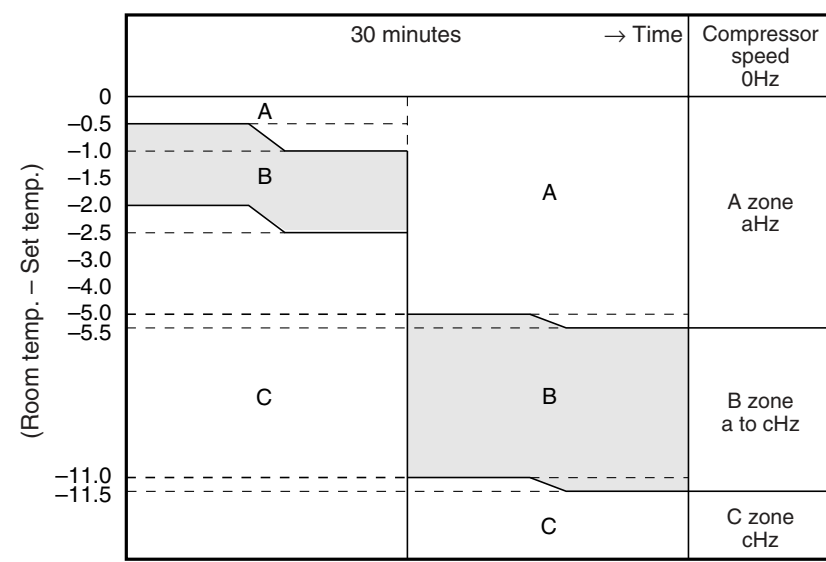
Item	Operation flow and applicable data, etc.	Description																																																																																																																													
<p>9. ECO operation</p>	<p>When pushing [ECO] button on the remote controller, a Economic operation is performed.</p> <p><Cooling operation></p> <p>This function operates the air conditioner with the difference between the set and the room temperature as shown in the following figure.</p>  <table border="1" data-bbox="798 403 1005 918"> <thead> <tr> <th>Zone</th> <th>Frequency</th> <th>FAN</th> </tr> </thead> <tbody> <tr><td>12</td><td>Dry Max</td><td></td></tr> <tr><td>11</td><td>*12</td><td></td></tr> <tr><td>10</td><td>*11</td><td></td></tr> <tr><td>9</td><td>*10</td><td></td></tr> <tr><td>8</td><td>*9</td><td></td></tr> <tr><td>7</td><td>*8</td><td></td></tr> <tr><td>6</td><td></td><td></td></tr> <tr><td>5</td><td></td><td></td></tr> <tr><td>4</td><td></td><td></td></tr> <tr><td>3</td><td></td><td></td></tr> <tr><td>2</td><td></td><td></td></tr> <tr><td>1</td><td>Min Hz</td><td></td></tr> <tr><td></td><td></td><td>OFF</td></tr> </tbody> </table> <p>Fan speed depend on presetting and can change every speed.</p> <p>* 12 (DRY max - COOL min) /6 × 5 + COOL min * 11 (DRY max - COOL min) /6 × 4 + COOL min * 10 (DRY max - COOL min) /6 × 3 + COOL min * 9 (DRY max - COOL min) /6 × 2 + COOL min * 8 (DRY max - COOL min) /6 × 1 + COOL min</p> <table border="1" data-bbox="526 1097 1005 1254"> <thead> <tr> <th>Hz</th> <th>RAS-18N3KV-E</th> <th>RAS-22N3KV-E</th> </tr> </thead> <tbody> <tr> <td>Cool min</td> <td>10</td> <td>10</td> </tr> <tr> <td>DRY max</td> <td>49</td> <td>50</td> </tr> </tbody> </table> <p><Heating operation></p>  <table border="1" data-bbox="861 1321 1005 1881"> <thead> <tr> <th>Compressor speed</th> <th>0Hz</th> <th>A zone aHz</th> <th>B zone a to cHz</th> <th>C zone cHz</th> </tr> </thead> <tbody> <tr> <td>0</td> <td></td> <td></td> <td></td> <td></td> </tr> <tr> <td>-0.5</td> <td></td> <td></td> <td></td> <td></td> </tr> <tr> <td>-1.0</td> <td></td> <td></td> <td></td> <td></td> </tr> <tr> <td>-1.5</td> <td></td> <td></td> <td></td> <td></td> </tr> <tr> <td>-2.0</td> <td></td> <td></td> <td></td> <td></td> </tr> <tr> <td>-2.5</td> <td></td> <td></td> <td></td> <td></td> </tr> <tr> <td>-3.0</td> <td></td> <td></td> <td></td> <td></td> </tr> <tr> <td>-4.0</td> <td></td> <td></td> <td></td> <td></td> </tr> <tr> <td>-5.0</td> <td></td> <td></td> <td></td> <td></td> </tr> <tr> <td>-5.5</td> <td></td> <td></td> <td></td> <td></td> </tr> <tr> <td>-11.0</td> <td></td> <td></td> <td></td> <td></td> </tr> <tr> <td>-11.5</td> <td></td> <td></td> <td></td> <td></td> </tr> </tbody> </table> <table border="1" data-bbox="526 1904 1005 2060"> <thead> <tr> <th>Hz</th> <th>RAS-18N3KV-E</th> <th>RAS-22N3KV-E</th> </tr> </thead> <tbody> <tr> <td>a</td> <td>10</td> <td>10</td> </tr> <tr> <td>c</td> <td>68</td> <td>72</td> </tr> </tbody> </table>	Zone	Frequency	FAN	12	Dry Max		11	*12		10	*11		9	*10		8	*9		7	*8		6			5			4			3			2			1	Min Hz				OFF	Hz	RAS-18N3KV-E	RAS-22N3KV-E	Cool min	10	10	DRY max	49	50	Compressor speed	0Hz	A zone aHz	B zone a to cHz	C zone cHz	0					-0.5					-1.0					-1.5					-2.0					-2.5					-3.0					-4.0					-5.0					-5.5					-11.0					-11.5					Hz	RAS-18N3KV-E	RAS-22N3KV-E	a	10	10	c	68	72	<p><Cooling operation></p> <ol style="list-style-type: none"> 1) The control target temperature increases 0.5°C per hour up to 2°C starting from the set temperature when ECONO has been received. 2) The indoor fan speed depends on presetting and can change every speed after setting ECO operation. 3) The compressor speed is controlled as shown in the left figure. <p><Heating operation></p> <ol style="list-style-type: none"> 1) Setting the compressor speed to Max. aHz, the temperature zone in which the operation can be performed with Max. cHz is gradually widened after 30 minutes passed when starting ECO operation. 2) The indoor fan speed depends on presetting and can change every speed after setting ECO operation.
Zone	Frequency	FAN																																																																																																																													
12	Dry Max																																																																																																																														
11	*12																																																																																																																														
10	*11																																																																																																																														
9	*10																																																																																																																														
8	*9																																																																																																																														
7	*8																																																																																																																														
6																																																																																																																															
5																																																																																																																															
4																																																																																																																															
3																																																																																																																															
2																																																																																																																															
1	Min Hz																																																																																																																														
		OFF																																																																																																																													
Hz	RAS-18N3KV-E	RAS-22N3KV-E																																																																																																																													
Cool min	10	10																																																																																																																													
DRY max	49	50																																																																																																																													
Compressor speed	0Hz	A zone aHz	B zone a to cHz	C zone cHz																																																																																																																											
0																																																																																																																															
-0.5																																																																																																																															
-1.0																																																																																																																															
-1.5																																																																																																																															
-2.0																																																																																																																															
-2.5																																																																																																																															
-3.0																																																																																																																															
-4.0																																																																																																																															
-5.0																																																																																																																															
-5.5																																																																																																																															
-11.0																																																																																																																															
-11.5																																																																																																																															
Hz	RAS-18N3KV-E	RAS-22N3KV-E																																																																																																																													
a	10	10																																																																																																																													
c	68	72																																																																																																																													

Item	Operation flow and applicable data, etc.	Description														
<p>10. Temporary operation</p> <pre> graph TD A[Filter lamp ON] -- YES --> B[Push RESET button.] A -- NO --> C{Did you push [RESET] button for 3 seconds or more?} C -- NO --> D[Temporary [AUTO] operation] C -- YES --> E{Did you push [RESET] button for 10 seconds or more?} E -- YES --> F[Temporary [COOL] Operation] E -- NO --> G[Switch to [AUTO RESTART] control.] B --> A </pre>	<p>Pushing [RESET] button starts the temporary operation of [AUTO] operation. When keeping [RESET] button pushed for 10 seconds or more, the temporary [COOL] operation is performed.</p>	<ol style="list-style-type: none"> 1) When pushing [RESET] button, the temporary [AUTO] operation starts. 2) When keeping [RESET] button pushed for 3 seconds or more, Pi, Pi, Pi sound is heard and [AUTO RESTART] control is changed. 3) When keeping [RESET] button pushed for 10 seconds or more, "Pi" sound is heard and the temporary [COOL] operation starts. 4) If the filter lamp goes on, push [RESET] button to go off the filter lamp, and then push [RESET] button again. 5) To stop the temporary operation, push the button again. 														
<p>11. Discharge temperature control</p> <table border="1" data-bbox="161 824 922 1160"> <thead> <tr> <th data-bbox="161 824 316 869">Td value</th> <th data-bbox="316 824 922 869">Control operation</th> </tr> </thead> <tbody> <tr> <td data-bbox="161 869 316 913">117°C</td> <td data-bbox="316 869 922 913">Judges as an error and stops the compressor.</td> </tr> <tr> <td data-bbox="161 913 316 958">112°C</td> <td data-bbox="316 913 922 958">Reduce the compressor speed.</td> </tr> <tr> <td data-bbox="161 958 316 1003">108°C</td> <td data-bbox="316 958 922 1003">Reduce slowly compressor speed.</td> </tr> <tr> <td data-bbox="161 1003 316 1048">105°C</td> <td data-bbox="316 1003 922 1048">Keeps the compressor speed.</td> </tr> <tr> <td data-bbox="161 1048 316 1126">98°C</td> <td data-bbox="316 1048 922 1126">If the operation is performed with lower speed than one commanded by the serial signal, speed is slowly raised up to the commanded speed.</td> </tr> <tr> <td data-bbox="161 1126 316 1160">98°C</td> <td data-bbox="316 1126 922 1160">Operates with speed commanded by the serial signal.</td> </tr> </tbody> </table>	Td value	Control operation	117°C	Judges as an error and stops the compressor.	112°C	Reduce the compressor speed.	108°C	Reduce slowly compressor speed.	105°C	Keeps the compressor speed.	98°C	If the operation is performed with lower speed than one commanded by the serial signal, speed is slowly raised up to the commanded speed.	98°C	Operates with speed commanded by the serial signal.		<ol style="list-style-type: none"> 1. Purpose This function detects error on the refrigerating cycle or error on the compressor, and performs protective control. 2. Operation <ul style="list-style-type: none"> • Control of the compressor speed The speed control is performed as described in the left table based upon the discharge temperature.
Td value	Control operation															
117°C	Judges as an error and stops the compressor.															
112°C	Reduce the compressor speed.															
108°C	Reduce slowly compressor speed.															
105°C	Keeps the compressor speed.															
98°C	If the operation is performed with lower speed than one commanded by the serial signal, speed is slowly raised up to the commanded speed.															
98°C	Operates with speed commanded by the serial signal.															

Item	Operation flow and applicable data, etc.	Description
<p>12. Pulse motor valve (PMV) control</p>	<p>This function controls throttle amount of the refrigerant in the refrigerating cycle. According to operating status of the air conditioner, this function also controls the open degree of valve with an expansion valve with pulse motor.</p> <pre> graph TD Start[Starting up] --> Init[Initialize] Init --> Move[Move to initial position] Move --> SH[SH control] Move --> Td[Td release control] SH --> PMV[PMV open degree control] Td --> PMV PMV --> Remote[Stop by remote controller] Remote --> Power[Power OFF] PMV --> Room[Room temp. sensor Ta sensor control] Room --> Defrost[Defrost] Defrost --> Move </pre> <p>* SH (Super Heat amount) = Ts (Temperature of suction pipe of the compressor) – Tc or Te (Heat exchanger temperature at evaporation side)</p> <p>* PMV: Pulse Motor Valve</p>	<ol style="list-style-type: none"> 1) When starting the operation, move the valve once until it fits to the stopper. (Initialize) * In this time, "Click" sound may be heard. 2) Adjust the open degree of valve by super heat amount. (SH control) 3) If the discharge temperature was excessively up, adjust the open degree of valve so that it is in the range of set temperature. (Discharge temp. control) 4) When defrost operation is performed, the open degree of valve is adjusted according to each setup conditions during preparation for defrost or during defrost operation (4-way valve is inversed.). 5) To turn off the compressor while the air conditioner stops by control of the thermostat or by remote controller, adjust the open degree of valve to the setup value before stop of the compressor.

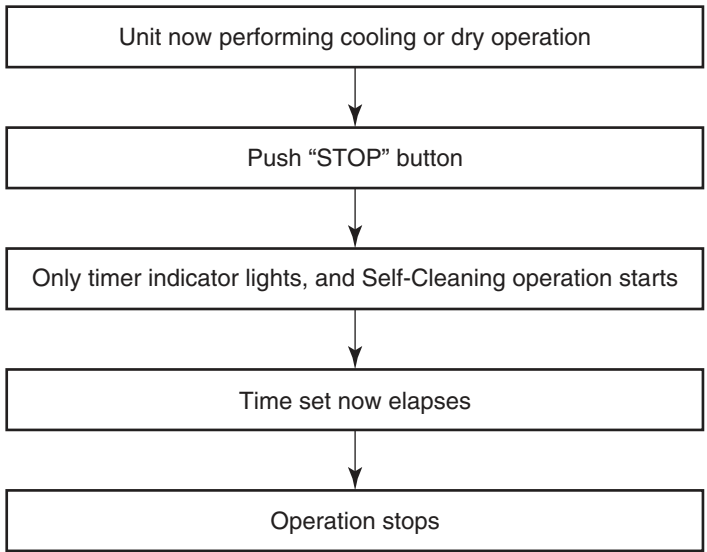
Item	Operation flow and applicable data, etc.	Description													
<p>13. Self-Cleaning function</p>	 <pre> graph TD A[Unit now performing cooling or dry operation] --> B[Push "STOP" button] B --> C[Only timer indicator lights, and Self-Cleaning operation starts] C --> D[Time set now elapses] D --> E[Operation stops] </pre> <ul style="list-style-type: none"> • During Self-Cleaning operations: The louver opens slightly. The indoor fan operates continuously at a speed of 500 rpm. <p>Self-Cleaning operation times</p> <table border="1" data-bbox="406 1137 1316 1422"> <thead> <tr> <th></th> <th>Operation time</th> <th>Self-Cleaning operation time</th> </tr> </thead> <tbody> <tr> <td rowspan="2">Cooling: Auto (cooling) Dry</td> <td>Up to 10 minutes</td> <td>No Self-Cleaning operation performed (0 minutes)</td> </tr> <tr> <td>10 minutes or longer</td> <td>30 minutes</td> </tr> <tr> <td>Heating: Auto (heating)</td> <td colspan="2" rowspan="3">No Self-Cleaning operation performed</td> </tr> <tr> <td>Auto (fan only)</td> </tr> <tr> <td>Shutdown</td> </tr> </tbody> </table> <ul style="list-style-type: none"> • To stop an ongoing Self-Cleaning operation at any time Push the start/stop button on the remote controller twice during the Self-Cleaning operation. (After pushing the button for the first time, push it for the second time without delay (within 10 minutes).) 		Operation time	Self-Cleaning operation time	Cooling: Auto (cooling) Dry	Up to 10 minutes	No Self-Cleaning operation performed (0 minutes)	10 minutes or longer	30 minutes	Heating: Auto (heating)	No Self-Cleaning operation performed		Auto (fan only)	Shutdown	<p>1. Purpose</p> <p>The Self-Cleaning operation is to minimize the growth of mold, bacteria etc. by running the fan and drying so as to keep the inside of the air conditioner clean.</p> <p>Self-Cleaning operation</p> <p>When the cooling or dry operation shuts down, the unit automatically starts the Self-Cleaning operation which is then performed for the specified period based on duration of the operation which was performed prior to the shutdown, after which the Self-Cleaning operation stops. (The Self-Cleaning operation is not performed after a heating operation.)</p> <p>2. Operation</p> <ol style="list-style-type: none"> 1) When the stop signal from the remote controller or timer-off function is received, only the timer indicator light. 2) The period of the Self-Cleaning operation is determined by the duration of the operation performed prior to the reception of the stop code. 3) After the Self-Cleaning operation has been performed for the specified period, the unit stops operating.
	Operation time	Self-Cleaning operation time													
Cooling: Auto (cooling) Dry	Up to 10 minutes	No Self-Cleaning operation performed (0 minutes)													
	10 minutes or longer	30 minutes													
Heating: Auto (heating)	No Self-Cleaning operation performed														
Auto (fan only)															
Shutdown															

Item	Operation flow and applicable data, etc.	Description																								
<p>13. Self-Cleaning function</p>	<ul style="list-style-type: none"> Self-Cleaning diagram <table border="1" data-bbox="169 286 1423 591"> <thead> <tr> <th>Operation display</th> <th>ON</th> <th>OFF</th> <th>OFF</th> </tr> </thead> <tbody> <tr> <td>FCU fan</td> <td>ON rpm is depend on presetting.</td> <td>ON (500RPM)</td> <td>OFF</td> </tr> <tr> <td>FCU louver</td> <td>OPEN</td> <td>OPEN (12.7°)</td> <td>CLOSE</td> </tr> <tr> <td>Timer display</td> <td>ON or OFF depend on presetting of timer function.</td> <td>ON</td> <td>ON or OFF depend on presetting of timer function.</td> </tr> <tr> <td>Compressor</td> <td>ON or OFF depend on presetting per room temperature.</td> <td>OFF</td> <td>OFF</td> </tr> <tr> <td>CDU fan</td> <td>ON or OFF depend on presetting per room temperature.</td> <td>OFF</td> <td>OFF</td> </tr> </tbody> </table> <div data-bbox="389 613 1423 801"> <p style="text-align: center;"> Turn off by remote controller or timer-off function. Automatically turn-off. </p> </div>	Operation display	ON	OFF	OFF	FCU fan	ON rpm is depend on presetting.	ON (500RPM)	OFF	FCU louver	OPEN	OPEN (12.7°)	CLOSE	Timer display	ON or OFF depend on presetting of timer function.	ON	ON or OFF depend on presetting of timer function.	Compressor	ON or OFF depend on presetting per room temperature.	OFF	OFF	CDU fan	ON or OFF depend on presetting per room temperature.	OFF	OFF	
Operation display	ON	OFF	OFF																							
FCU fan	ON rpm is depend on presetting.	ON (500RPM)	OFF																							
FCU louver	OPEN	OPEN (12.7°)	CLOSE																							
Timer display	ON or OFF depend on presetting of timer function.	ON	ON or OFF depend on presetting of timer function.																							
Compressor	ON or OFF depend on presetting per room temperature.	OFF	OFF																							
CDU fan	ON or OFF depend on presetting per room temperature.	OFF	OFF																							
<p>14. Remote Controller-A or B selection</p>	<p>Setting the remote controller</p> <p>To separate using of remote controller for each indoor unit in case of 2 air conditioner are installed nearby.</p> <p>Remote Control B Setup.</p> <ol style="list-style-type: none"> Press [RESET] button on the indoor unit to turn the air conditioner ON. Point the remote control at the indoor unit. Push and hold [CHECK] button on the Remote Control by the tip of the pencil. "00" will be shown on the display (Picture ①). Press [MODE] during pushing [CHECK]. "B" will show on the display and "00" will disappear and the air conditioner will turn OFF. The Remote Control B is memorized (Picture ②). <p>NOTE :</p> <ol style="list-style-type: none"> Repeat above step to reset Remote Control to be A. Remote Control A has not "A" display. Default setting of Remote Control from factory is A. <div data-bbox="437 1621 951 1792"> </div>	<ol style="list-style-type: none"> Purpose This operation is to operate only one indoor unit using one remote controller. Description When operating one indoor unit in a situation where two indoor units have been installed in the same room or nearby rooms, this operation prevents the remote controller signal from being received simultaneously by both units, thus preventing both units from operating. Operation The indoor unit on which the remote controller selection has been set to B receives the signal of the remote controller also set to B. (At the factory the remote controller selection is set to A on all the indoor units. There is no A setting display.) 																								

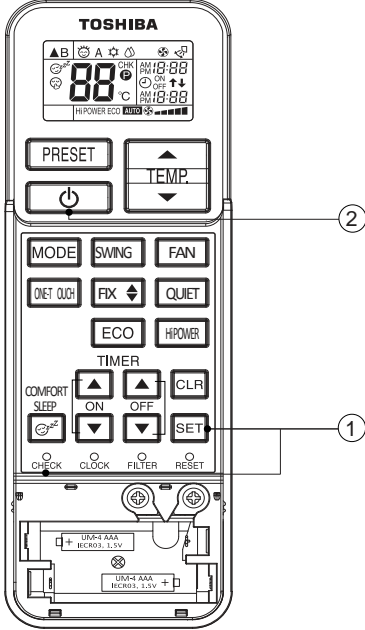
Item	Operation flow and applicable data, etc.	Description
<p>15. QUIET mode</p>	<p>When the [QUIET] button is pushed, the fan of the indoor unit will be restricted the revolving speed at speed L - until the [QUIET] button is pushed once again (cancel Quiet mode).</p>	<p>Quiet mode is the system which, control the revolving speed of indoor fan to work constantly at lower than speed L. In addition, noise level of indoor unit is less than usual.</p> <p>Remarks :</p> <ol style="list-style-type: none"> 1. Quiet mode is unable to work in dry mode. 2. Quiet mode is appropriate to work with less cooling load and less heating load condition. Because of the fan speed L- may cause not enough the cooling capacity or heating capacity.
<p>16. COMFORT SLEEP</p>	<p>Cooling mode</p> <ul style="list-style-type: none"> • The preset temperature will increase as shown on ECO operation (Item No. 9) • Push the [COMFORT SLEEP] button to choose the operating hours. Repeat pushing to select the hours. (1hr, 3hr, 5hr or 9hr) • If the [COMFORT SLEEP] button is pushed again means cancel comfort sleep mode. <p>Heating mode</p> <ul style="list-style-type: none"> • The preset temperature will drop down as shown on ECO operation (Item No. 9) • Push the [COMFORT SLEEP] button to choose the operating hours. Repeat pushing to select the hours. (1hr, 3hr, 5hr or 9hr) • If the [COMFORT SLEEP] button is pushed again means cancel comfort sleep mode. 	<p>The principles of comfort sleep mode are:</p> <ul style="list-style-type: none"> • Quietness for more comfortable. When room temperature reach setting temperature • Save energy by changing room temperature automatically. • The air condition can shut down by itself automatically. <p>Remarks:</p> <ol style="list-style-type: none"> 1. Comfort sleep mode will not operate in dry mode and fan only mode.
<p>17. Short Timer</p>	<p>In the normal condition, after switching one circuit breaker, 3-minute delay time for compressor and 1 hour for plasma air purifier are set for the maintenance of the unit.</p> 	<p>Purpose</p> <p>To start the unit immediately for the purpose of testing, trial...etc, short timer can be used. maintenance of the unit.</p> <p>Short Timer Setting</p> <ol style="list-style-type: none"> ① Push [⏻] button to turn the unit OFF. ② Set the operation mode or plasma air purifier on the remote controller without sending the signal to the unit. ③ Use the tip of the pencil to push the [CHK] button and hold, "00" will show on display, then push [SET] button to make "00" disappear. ④ Push [⏻] button to turn the unit ON. ⑤ When short timer is activated, all setting on the remote controller operates immediately, besides, all indicators on front panel turn ON continuously for 3 seconds.

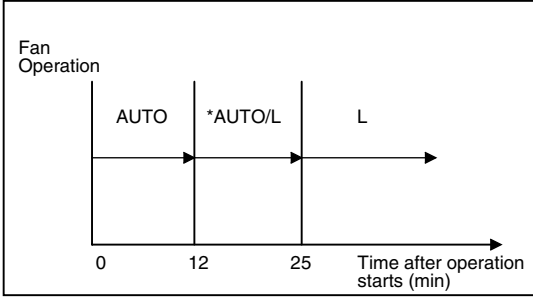
Item	Operation flow and applicable data, etc.	Description
<p>18. One Touch Comfort</p>	<p>One touch comfort is the fully automated operation that is set according to the preferable condition in a region.</p>  <p>* AUTO/L: Fan operates depends on the setting temperature and room temperature.</p> <p>During the One Touch Comfort mode if the indoor unit receives any signal with other operation mode, the unit will cancel the comfort mode and operates according to the signal received.</p>	<p>Operation condition for model to Europe market</p> <p>When an indoor unit receives “One Touch Comfort Signal” from the remote controller, the indoor unit operates as following.</p> <ol style="list-style-type: none"> 1) Air conditioner starts to operation when the signal is received, even if the air conditioner was OFF. 2) Operation mode is set according to room temperature, the same as AUTO mode. 3) Target temperature is 24°C. 4) Louver position is set as stored position of the operating mode. 5) Fan is controlled as followings.
<p>19. Hi POWER Mode</p>	<p>([Hi-POWER] button on the remote controller is pushed)</p> <p>When [Hi-POWER] button is pushed while the indoor unit is in Auto, Cooling or Heating operation, Hi POWER mark is indicated on the display of the remote controller and the unit operates as follows.</p> <ol style="list-style-type: none"> 1. Automatic operation <ul style="list-style-type: none"> • The indoor unit operates in according to the current operation. 2. Cooling operation <ul style="list-style-type: none"> • The preset temperature drops 1 degree (The value of the preset temperature on the remote controller does not change.) The indoor unit's fan speed level increases 1 tap. 3. Heating operation <ul style="list-style-type: none"> • The preset temperature increases 2 degree (The value of the preset temperature on the remote controller does not change.) The indoor unit's fan speed level increases 1 tap 4. The Hi POWER mode can not be set in Dry operation 	
<p>20. FILTER Indicator</p>	<p>When the elapsed time reaches 1000 hours after air conditioner operation, the FILTER indicator lights. After cleaning the filters, turn off the FILTER indicator.</p> <p>How to Turn Off FILTER Indicator</p> <p>Push [RESET] button on the indoor unit.</p> <p>NOTE :</p> <p>If [RESET] button is pushed while the FILTER indicator is not lit, the indoor unit will start the automatic operation.</p> <p>When you want a temporary operation while the FILTER lamp lights, push [RESET] button to turn off the FILTER lamp.</p>	

9-3. Auto Restart Function

This indoor unit is equipped with an automatic restarting function which allows the unit to restart operating with the set operating conditions in the event of a power supply being accidentally shut down.

The operation will resume without warning three minutes after power is restored.

This function is not set to work when shipped from the factory. Therefore it is necessary to set it to work.

9-3-1. How to Set the Auto Restart Function

To set the auto restart function, proceed as follows:

The power supply to the unit must be on; the function will not set if the power is off.

Push the [RESET] button located in the center of the front panel continuously for three seconds.

The unit receives the signal and beeps three times.

The unit then restarts operating automatically in the event of power supply being accidentally shut down.

• When the unit is stand-by (Not operating)

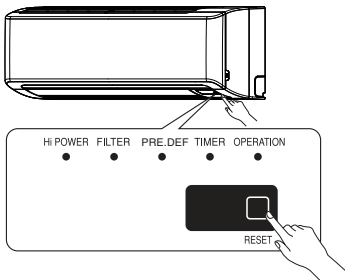
Operation	Motions
<p>Push [RESET] button for more than three seconds. (Less than 10 seconds)</p> 	<p>The unit is on standby.</p> <p style="text-align: center;">↓</p> <p>The unit starts to operate. The green indicator is on.</p> <p style="text-align: center;">↓ After approx. three seconds,</p> <p>The unit beeps three times and continues to operate. The green indicator flashes for 5 seconds.</p> <p>If the unit is not required to operate at this time, push [RESET] button once more or use the remote controller to turn it off.</p>

• When the unit is in operation

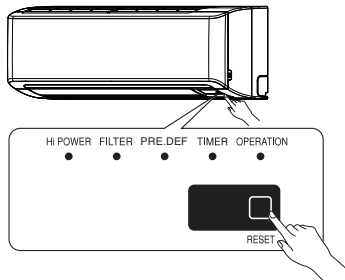
Operation	Motions
<p>Push [RESET] button for more than three seconds. (Less than 10 seconds)</p> 	<p>The unit is in operation. The green indicator is on.</p> <p style="text-align: center;">↓</p> <p>The unit stops operating. The green indicator is turned off.</p> <p style="text-align: center;">↓ After approx. three seconds,</p> <p>The unit beeps three times. The green indicator flashes for 5 seconds.</p> <p>If the unit is required to operate at this time, push [RESET] button once more or use the remote controller to turn it on.</p>

- While the filter check indicator is on, the RESET button has the function of filter reset button.

9-3-2. How to Cancel the Auto Restart Function

To cancel auto restart function, proceed as follows :

Repeat the setting procedure : the unit receives the signal and beeps three times.

The unit will be required to be turned on with the remote controller after the main power supply is turned off.

• **When the system is on stand-by (not operating)**

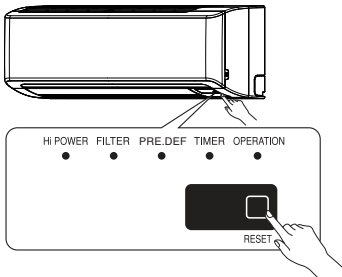
Operation	Motions
<p>Push [RESET] button for more than three seconds. (Less than 10 seconds)</p> 	<p>The unit is on standby.</p> <p>↓</p> <p>The unit starts to operate. The green indicator is on.</p> <p>↓ After approx. three seconds,</p> <p>The unit beeps three times and continues to operate.</p> <p>If the unit is not required to operate at this time, push [RESET] button once more or use the remote controller to turn it off.</p>

• **When the system is operating**

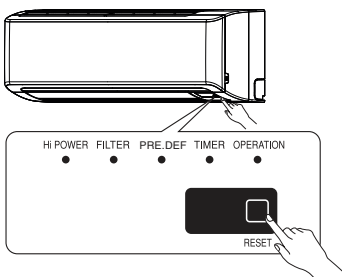
Operation	Motions
<p>Push [RESET] button for more than three seconds. (Less than 10 seconds)</p> 	<p>The unit is in operation. The green indicator is on.</p> <p>↓</p> <p>The unit stops operating. The green indicator is turned off.</p> <p>↓ After approx. three seconds,</p> <p>The unit beeps three times.</p> <p>If the unit is required to operate at this time, push [RESET] button once more or use the remote controller to turn it on.</p>

9-3-3. Power Failure during Timer Operation

When the unit is turned off because of power failure during timer operation, the timer operation is cancelled.

In that case, set the timer operation again.

NOTE :

The Daily Timer is reset while a command signal can be received from the remote controller even if it stopped due to a power failure.

9-4. Remote control

9-4-1. Remote Controller and Its Functions

- ① Infrared signal emitter
- ② Start/Stop button
- ③ Mode select button (MODE)
- ④ Temperature button (TEMP)
- ⑤ Fan speed button (FAN)
- ⑥ Swing louver button (SWING)
- ⑦ Set louver button (FIX)
- ⑧ On timer button (ON)
- ⑨ Off timer button (OFF)
- ⑩ Setup button (SET)
- ⑪ Clear button (CLR)
- ⑫ Memory and Preset button (PRESET)
- ⑬ One-Touch button (ONE-TOUCH)
- ⑭ High power button (Hi-POWER)
- ⑮ Economy button (ECO)
- ⑯ Quiet button (QUIET)
- ⑰ Comfort sleep button (COMFORT SLEEP)
- ⑱ Filter reset button (FILTER)
- ⑲ Set clock button (CLOCK)
- ⑳ Check button (CHECK)
- ㉑ Reset button (RESET)

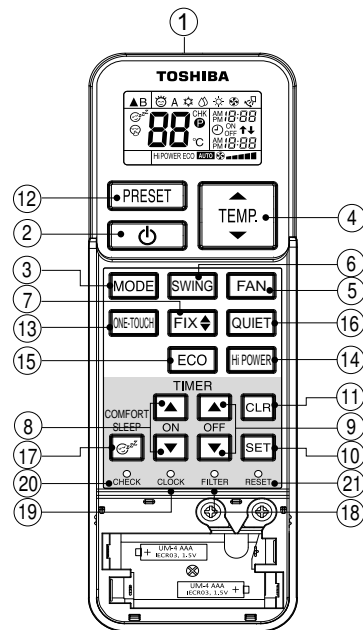

Note:

- The provided Remote Controller is a wireless type, which also can be used as a wire. Please see "How to Connect The Remote Controller for Wired Operation", located in installation instruction, in case of wired control is required.
- In wire operation, remote controller will return to initial condition (PRESET, TIMER and CLOCK will return to initial condition) when user shutdown power supply of Air conditioner.

9-4-2. Operation of remote control

1. ONE-TOUCH

Press the "ONE-TOUCH" button for fully automated operation that is customised to the typical consumer preferences in your region of the world. The customised settings control temperature air flow strength, air flow direction and other settings to provide you alternate contact with "ONE-TOUCH" OF THE BUTTON. If you prefer other settings you can select from the many other operation functions of your Toshiba unit

Press : Start the operation.

2. AUTOMATIC OPERATION

To automatically select cooling, or fan only operation.

1. Press : Select A.
2. Press : Set the desired temperature.



3. COOLING / HEATING / FAN ONLY OPERATION

To automatically select cooling, or fan only operation.

1. Press : Select Cool , Heat , or Fan only .
2. Press : Set the desired temperature.
Cooling / Heating : Min 17°C - Max 30°C, Fan Only: No temperature indication
3. Press : Select AUTO, LOW , LOW+ , MED , MED+ , or HIGH .

4. DRY OPERATION (COOLING ONLY)

For dehumidification, a moderate cooling performance is controlled automatically.

1. Press  : Select Dry .
2. Press  : Set the desired temperature.

5. HI-POWER OPERATION

To automatically control room temperature and airflow for faster cooling operation (except in DRY and FAN ONLY mode).

Press  : Start and stop the operation.

6. ECO OPERATION

To automatically control room to save energy (except in DRY and FAN ONLY mode)

Press  : Start and stop the operation.

Note: Cooling operation; the set temperature will increase automatically 1°C/hour for 2 hours (maximum 2 °C increase).







Heating operation : the set temperature will decrease.

7. TEMPORARY OPERATION

In case of the misplaced or discharged remote control





- Pressing the RESET button, the unit can start or stop without using the remote control.
- Operation mode is set on AUTOMATIC operation, preset temperature is 24°C and fan operation is automatic speed.

8. TIMER OPERATION

	Setting the ON Timer	Setting the OFF Timer
1	Press  : Set the desired ON timer.	Press  : Set the desired OFF timer.
2	Press  : Set the timer	Press  : Set the timer.
3	Press  : Cancel the timer	Press 

Daily timer allows the user to set both the ON & OFF timers and will be activated on a daily basis.

Setting Daily Timer

1	Press  : Set the ON timer .	3	Press  .
2	Press  : Set the OFF timer .	4	Press  button during the (↑ or ↓) mark flashing.



- During the daily timer is activation, both arrows (↑ or ↓) are indicated.

Note:

- Keep the remote control in accessible transmission to the indoor unit; otherwise, the time lag of up to 15 minutes will occur.
- The setting will be saved for the next same operation.

9. PRESET OPERATION

Set your preferred operation for future use. The setting will be memorized by the unit for future operation (except air flow direction).

1. Select your preferred operation.
2. Press and hold  for 3 seconds to memorize the setting. The  mark displays.
3. Press : Operate the preset operation.

10. AUTO RESTART OPERATION

To automatically restart the conditioner after the power failure (Power of the unit must be on.)

Setting

1. Press and hold the RESET button on the indoor unit for 3 seconds to set the operation. (3 beep sound and OPERATION lamp blink 5 time/sec for 5 seconds)
 - Do not operate ON timer and OFF timer.
2. Press and hold the RESET button on the indoor unit for 3 seconds to cancel the operation. (3 beep sound but OPERATION lamp does not blink)

11. QUIET OPERATION

To operate at super low fan speed for quiet operation (except in DRY mode)

Press : Start and stop the operation.

Note: Under certain conditions, QUIET operation may not provide adequate cooling due to low sound features.

12. COMFORT SLEEP OPERATION

To save energy while sleeping, automatically control air flow and automatically turn OFF.











Press : Select 1, 3, 5 or 9 hrs for OFF timer operation.

Note: The cooling operation, the set temperature will increase automatically 0.5 degree/hour for 4 hours (maximum 2 degrees increase).

9-4-3. Names and Functions of Indications on Remote Controller

[Display]

All indications, except for the clock time indicator, are displayed by pushing the  button.

- 1 Transmission mark**
This transmission mark  indicates when the remote controller transmits signals to the indoor unit.
- 2 Mode indicator**
Indicates the current operation mode.
(AUTO : Automatic control, A : Auto changeover control,  : Cool,  : Dry,  : Heat)
- 3 Temperature indicator**
Indicates the temperature setting.
(17°C to 30°C)
- 4 FAN speed indicator**
Indicates the selected fan speed.
AUTO or five fan speed levels (LOW , LOW+ , MED , MED+ , HIGH ) can be shown.
Indicates AUTO when the operating mode is either AUTO or  : Dry.
- 5 TIMER and clock time indicator**
The time setting for timer operation or the clock time is indicated.
The current time is always indicated except during TIMER operation.
- 6 Hi POWER indicator**
Indicates when the Hi POWER operation starts.
Push the Hi-POWER button to start and push it again to stop the operation.
- 7 P (PRESET) indicator**
Flashes for 3 seconds when the PRESET button is pushed during operation.
The  mark is shown when holding down the button for more than 3 seconds while the mark is flashing.
Push another button to turn off the mark.
- 8 ECO indicator**
Indicates when the ECO is in activated.
Push the ECO button to start and push it again to stop operation.
- 9 A, B change indicator remote controller**
When the remote controller switching function is set, "B" appears in the remote controller display.
(When the remote controller setting is "A", there is no indication at this position.)
- 10 Comfort sleep**
Indicates when comfort sleep is activated.
Push comfort sleep button to select.
- 11 Quiet**
Indicates when quiet is activated.
Push quiet button to start and push it again to stop operation.
- 12 One-Touch**
Indicates when one touch comfort is activated.
Push one-touch button to start the operation.
- 13 Swing**
Indicates when louver is swing.
Push swing button to start the swing operation and push it again to stop the swing operation.

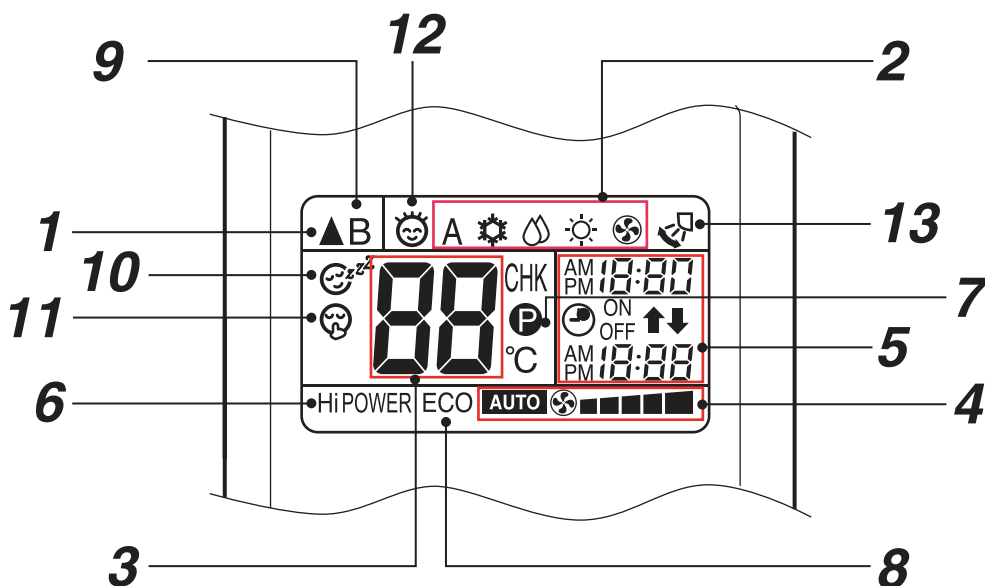

10. INSTALLATION PROCEDURE

10-1. Installation Diagram of Indoor and Outdoor Units

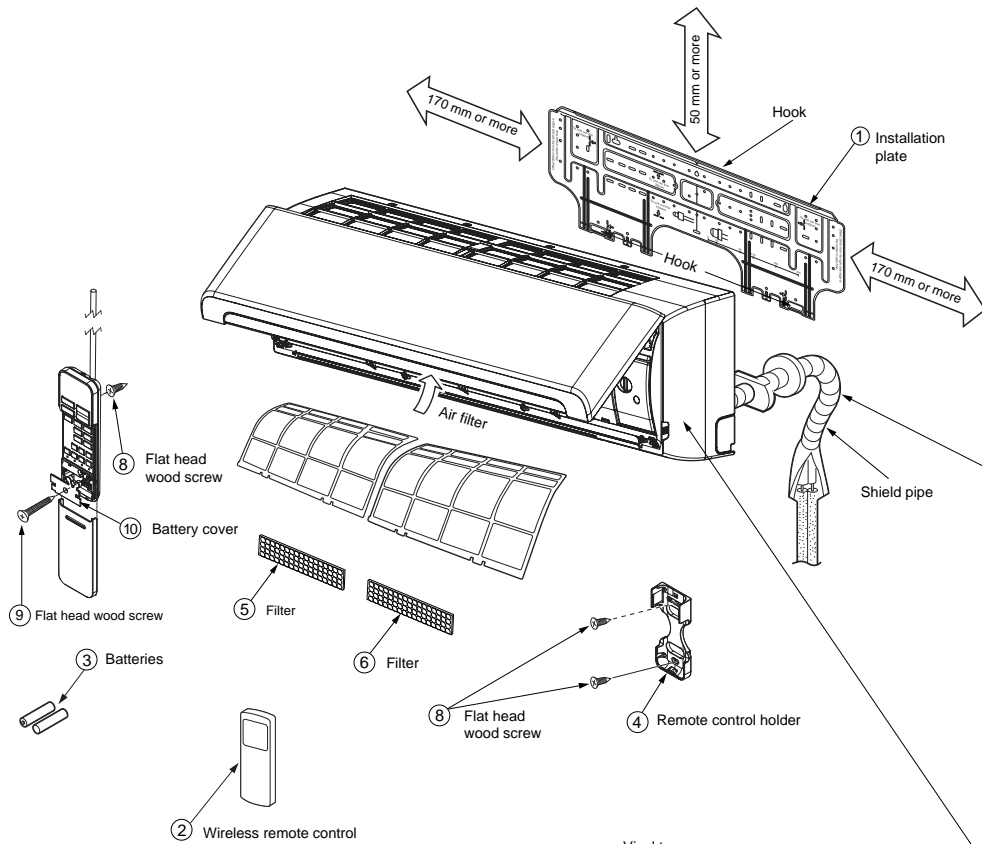

For the rear left and left piping

Insert the cushion between the indoor unit and wall, and tilt the indoor unit for better operation.

Do not allow the drain hose to get slack.

Cut the piping hole sloped slightly.

Make sure to run the drain hose sloped downward.

The auxiliary piping can be connected to the left, rear left, rear right, right, bottom right or bottom left.

Right, Rear right, Bottom right, Rear left, Bottom left, Left

Insulate the refrigerant pipes separately with insulation, not together.

8 mm thick heat resisting polyethylene foam

The provided Remote Controller is a wireless type, which also can be used as a wire.

Please see "How to Connect The Remote Controller for Wired Operation", in case of wired control is required.

When installing the outdoor unit, leave open in at least two of direction (A), (B), (C) and (D) shown in the figure on the right.

Remark :

- Detail of accessory and installation parts can see in the accessory sheet.
- Some pictures might be different from the actual parts.

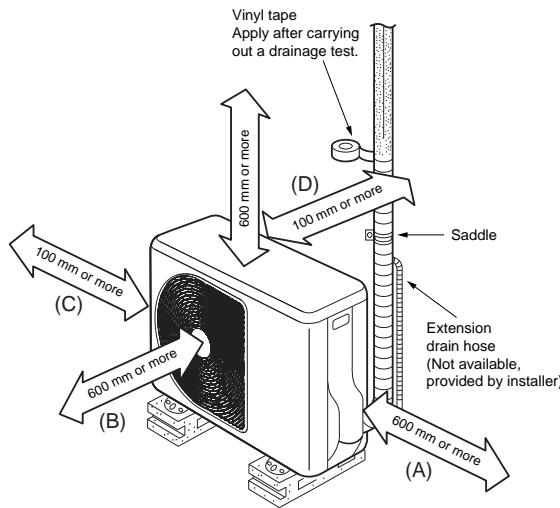

Before installing the wireless remote controller

• Loading Batteries

1. Remove the battery cover.
2. Insert 2 new batteries (AAA type) following the (+) and (-) positions.

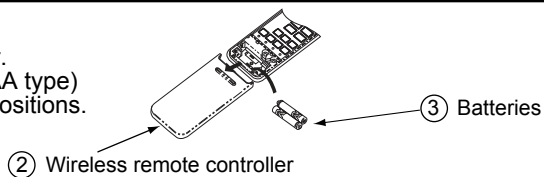

10-2. Optional Parts, Accessories and Tools

10-2-1. Optional installation parts

Part Code	Parts name	Q'ty
Ⓐ	Refrigerant piping Liquid side : $\varnothing 6.35$ mm Gas side : $\varnothing 12.70$ mm	One each
Ⓑ	Pipe insulating material (polyethylene foam, 8 mm thick)	1
Ⓒ	Putty, PVC tapes	One each

<Fixing bolt arrangement of outdoor unit>

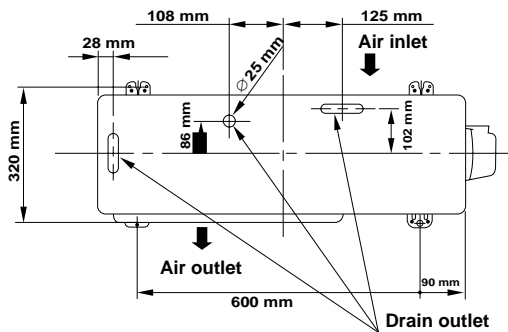
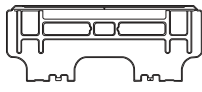





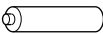





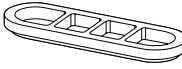

Fig. 10-2-1

- Secure the outdoor unit with fixing bolts and nuts if the unit is likely to be exposed to a strong wind.
- Use $\varnothing 8$ mm or $\varnothing 10$ mm anchor bolts and nuts.
- If it is necessary to drain the defrost water, attach drain nipple ⑨ and cap water proof ⑩ to the bottom plate of the outdoor unit before installing it.

10-2-2. Accessory and installation parts

Part No.	Part name (Q'ty)	Part No.	Part name (Q'ty)	Part No.	Part name (Q'ty)			
①	 Installation plate x 1	④	 Remote control holder x 1	⑨	 Flat head wood screw Ø3.1 x 25 l x 1			
②	 Wireless remote control x 1	⑤	 Filter x 1	⑩	 Battery-cover x 1			
③	 Battery x 2	⑥	 Filter x 1	⑪	 Screw Ø4 x 10 l x 2			
Others	<table border="1"> <thead> <tr> <th>Name</th> </tr> </thead> <tbody> <tr> <td>Owner's manual</td> </tr> <tr> <td>Installation manual</td> </tr> </tbody> </table>	Name	Owner's manual	Installation manual	⑦	 Mounting screw Ø4 x 25 l x 6	⑫	 Drain nipple* x 1
	Name							
	Owner's manual							
Installation manual								
	⑧	 Flat head wood screw Ø3.1 x 16 l x 2	⑬	 Cap water proof* x 2				

The part marked with asterisk (*) is packaged with the outdoor unit.







10-2-3. Installation/Serviceing Tools

Changes in the product and components

In the case of an air conditioner using R410A, in order to prevent any other refrigerant from being charged accidentally, the service port diameter of the outdoor unit control valve (3 way valve) has been changed. (1/2 UNF 20 threads per inch)

- In order to increase the pressure resisting strength of the refrigerant piping flare processing diameter and size of opposite side of flare nuts has been changed. (for copper pipes with nominal dimensions 1/2 and 5/8)

New tools for R410A

New tools for R410A	Applicable to R22 model		Changes
Gauge manifold	×		As pressure is high, it is impossible to measure by means of conventional gauge. In order to prevent any other refrigerant from being charged, each port diameter has been changed.
Charge hose	×		In order to increase pressure resisting strength, hose materials and port size have been changed (to 1/2 UNF 20 threads per inch). When purchasing a charge hose, be sure to confirm the port size.
Electronic balance for refrigerant charging	○		As pressure is high and gasification speed is fast, it is difficult to read the indicated value by means of charging cylinder, as air bubbles occur.
Torque wrench (nominal diam. 1/2, 5/8)	×		The size of opposite sides of flare nuts have been increased. Incidentally, a common wrench is used for nominal diameters 1/4 and 3/8.
Flare tool (clutch type)	○		By increasing the clamp bar's receiving hole, strength of spring in the tool has been improved.
Gauge for projection adjustment	—	—	Used when flare is made by using conventional flare tool.
Vacuum pump adapter	○		Connected to conventional vacuum pump. It is necessary to use an adapter to prevent vacuum pump oil from flowing back to the charge hose. The charge hose connecting part has two ports-one for conventional refrigerant (7/16 UNF 20 threads per inch) and one for R410A. If the vacuum pump oil (mineral) mixes with R410A a sludge may occur and damage the equipment.
Gas leakage detector	×		Exclusive for HFC refrigerant.

- Incidentally, the “refrigerant cylinder” comes with the refrigerant designation (R410A) and protector coating in the U. S.’s ARI specified rose color (ARI color code: PMS 507).
- Also, the “charge port and packing for refrigerant cylinder” require 1/2 UNF 20 threads per inch corresponding to the charge hose’s port size.

10-3. Indoor Unit

10-3-1. Installation Place

- A place which provides the spaces around the indoor unit as shown in the diagram.
- A place where there are no obstacle near the air inlet and outlet.
- A place which allows easy installation of the piping to the outdoor unit.
- A place which allows the front panel to be opened.
- The indoor unit shall be installed as top of the indoor unit comes to at least 2 m height. Also, it must be avoided to put anything on the top of the indoor unit.

- Direct sunlight on the indoor unit's wireless receiver should be avoided.
- The microprocessor in the indoor unit should not be too close to RF noise sources. (For details, see the owner's manual.)

<Remote control>

- A place where there are no obstacles such as a curtain that may block the signal from the remote control.
- Do not install the remote control in a place exposed to direct sunlight or close to a heating source such as a stove.
- Keep the remote control at least 1 m apart from the nearest TV set or stereo equipment. (This is necessary to prevent image disturbances or noise interference.)
- The location of the remote control should be determined as shown below.

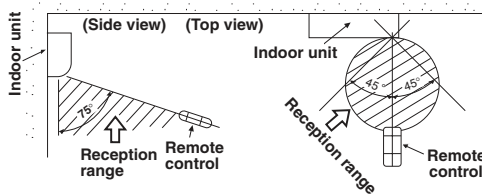

Fig. 10-3-1

10-3-2. Cutting a Hole and Mounting Installation Plate

<Cutting a hole>

When install the refrigerant pipes from the rear.

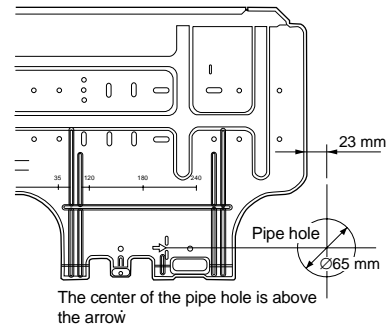

Fig. 10-3-2

1. After determining the pipe hole position on the installation plate (⇔) drill the pipe hole (Ø 65 mm) at a slight downward slant to the outdoor side.

NOTE :

- When drilling a wall that contains a metal lath, wire lath or metal plate, be sure to use a pipe hole brim ring sold separately.

<Mounting the installation plate>

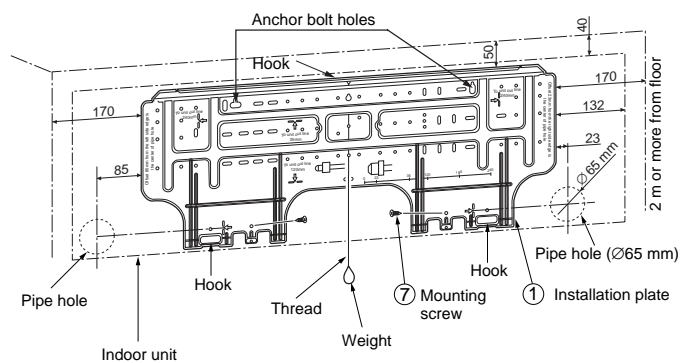

Fig. 10-3-3

<When the installation plate is directly mounted on the wall>

1. Securely fit the installation plate onto the wall by screwing it in the upper and lower parts to hook up the indoor unit.
2. To mount the installation plate on a concrete wall with anchor bolts, use the anchor bolt holes as illustrated in the below figure.
3. Install the installation plate horizontally in the wall.

When installing the installation plate with mounting screw, do not use the anchor bolt holes. Otherwise, the unit may fall down and result in personal injury and property damage.

Installation plate
<Keep horizontal direction>

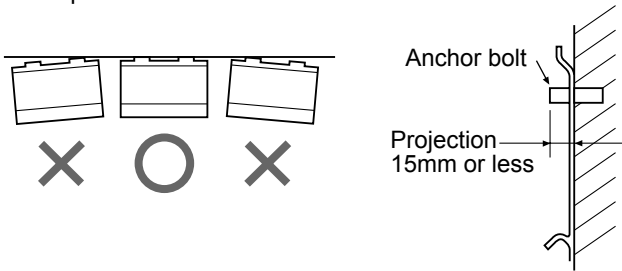

Fig. 10-3-4

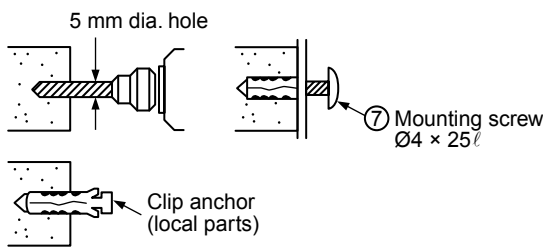

Fig. 10-3-5

Failure to firmly install the unit may result in personal injury and property damage if the unit falls.

- In case of block, brick, concrete or similar type walls, make 5 mm dia. holes in the wall.
- Insert clip anchors for appropriate mounting screws ⑦

NOTE :

- Secure four corners and lower parts of the installation plate with 4 to 6 mounting screws to install it.

10-3-3. Wiring Connection

<How to connect the connecting cable>

Wiring the connecting cable can be carried out without removing the front panel.

1. Remove the air inlet grille. Open the air inlet grille upward and pull it toward you.
2. Remove the terminal cover and cord clamp.
3. Insert the connecting cable (according to the local rule) into the pipe hole on the wall.
4. Take out the connecting cable through the cable slot on the rear panel so that it protrudes about 15 cm from the front.
5. Insert the connecting cable fully into the terminal block and secure it tightly with screws.
6. Tighten firmly but not over 1.2 N·m (0.12 kgf·m)
7. Secure the connecting cable with the cord clamp.
8. Fix the terminal cover, rear plate bushing and air inlet grille on the indoor unit.

CAUTION

- Be sure to refer to the wiring system diagram labeled inside the front panel.
- Check local electrical cords and also any specific wiring instructions or limitations.

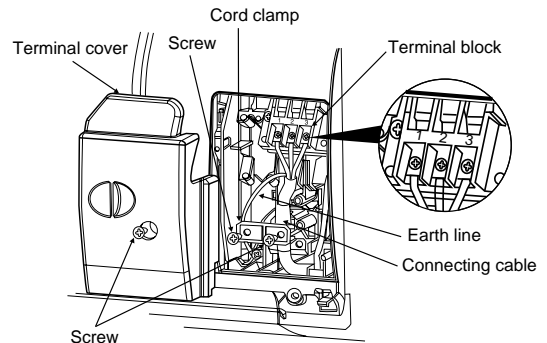

Fig. 10-3-6

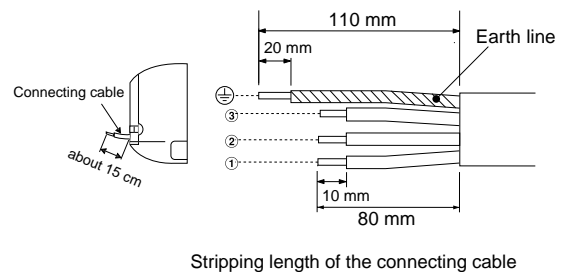

Fig. 10-3-7

NOTE :

- Use stranded wire only.
- Wire type : More than 1.5 mm² (H07RN-F or 60254 IEC66) or 1.3 mm² (AWG-16)

10-3-4. How to Connect Remote Controller for Wire Operation

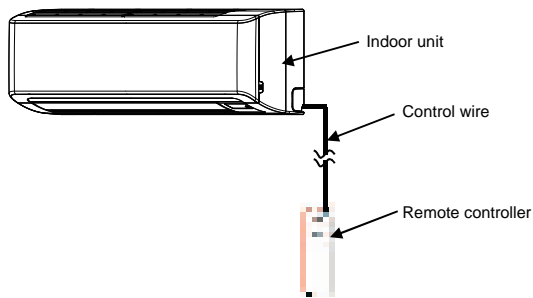

Fig. 10-3-8

<For indoor unit>

1. Open the air inlet grille upward.
2. Securely remove four screws at the front panel.
3. Slightly open the lower part of the front panel then pull the upper part of the front toward you to remove it from the rear plate as shown on figure ①.
4. After removing the front panel, remove the screws and Display unit from the unit as shown on figure ② then open the front cover of Display unit as shown on figure ③.
5. Arrange the control wire as detail and specification as shown on figure ④.
6. Securely connect the control wire to terminal of display unit board as shown on figure ⑤ (tighten firmly but not over : 0.12 N·m (0.01 kgf·m)).
7. Set the control wire throughout at slot on front cover of display unit then reassembly display with main casing by reverse process of figure ② and ③ . Make sure the control wire must not be pressed by front and rear cover of display unit.
8. Set the control wire out from indoor unit same portion as power supply and connecting cable as shown on figure ⑥.
9. Reassembly the indoor unit by reverse process of 1 to 3.

Fig. 10-3-9

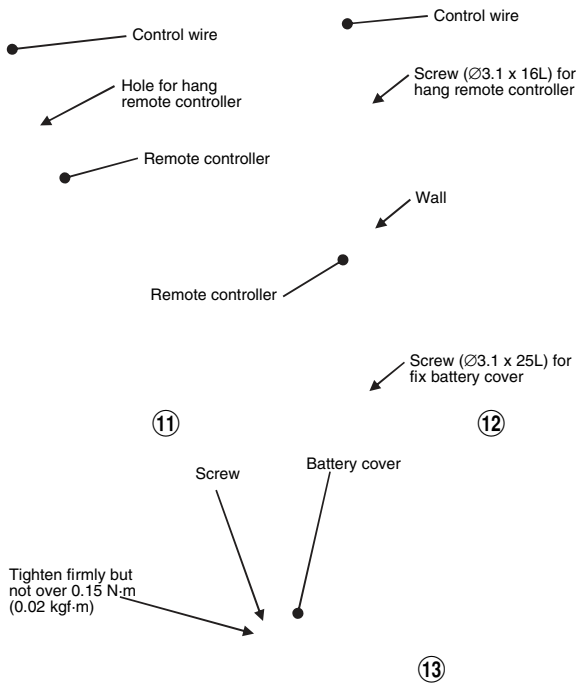

Fig. 10-3-12

***Remark :**

1. Recommend to use double insulation lead wire for connect remote control and air conditioner.
2. For wire operation, 1 remote control can control only 1 indoor unit.
3. In wire operation, remote controller will return to initial condition (PRESET, TIMER and CLOCK will return to initial condition) when user shutdown power supply of air conditioner.

<How to install the air inlet grille on the indoor unit>

- When attaching the air inlet grille, perform the same process as for removal but in reverse order.

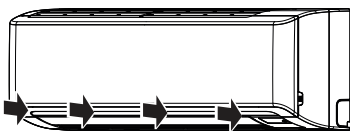

10-3-5. Piping and drain hose installation

<Piping and drain hose forming>

- * Since dewing results in a machine trouble, make sure to insulate both connecting pipes. (Use polyethylene foam as insulating material.)

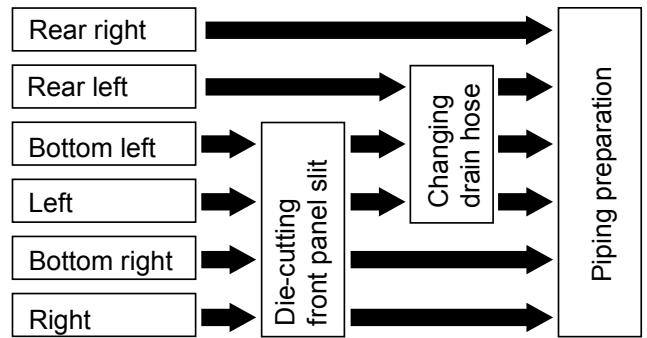

1. Die-cutting front panel slit

Cut out the slit on the left or right side of the front panel for the left or right connection and the slit on the bottom left or right side of the front panel for the bottom left or right connection with a pair of nippers.

2. Changing drain hose

For leftward connection, bottom leftward connection and rear leftward connection's piping, it is necessary to change the drain hose and drain cap.

<How to remove the drain cap>

Clip the drain cap by needle-nose pliers and pull out.

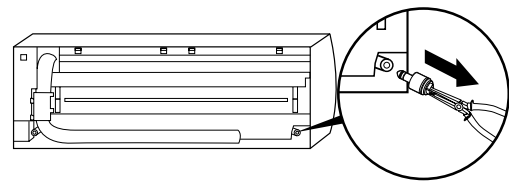

Fig. 10-3-13

<How to install the drain hose>

Firmly insert drain hose connecting part until hitting on a heat insulator and fix it with a screw.

<How to remove the drain hose>

- The drain hose can be removed by removing the screw securing the drain hose and then pulling out the drain hose.
- When removing the drain hose, be careful of any sharp edges of steel plate. The edges can injure.
- To install the drain hose, insert the drain hose firmly until the connection part contacts with heat insulator, and secure it with original screw.

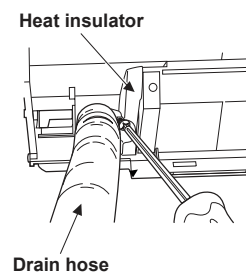

Fig. 10-3-14

<How to attach the drain cap>

1. Insert hexagon wrench (4 mm) in a center head.

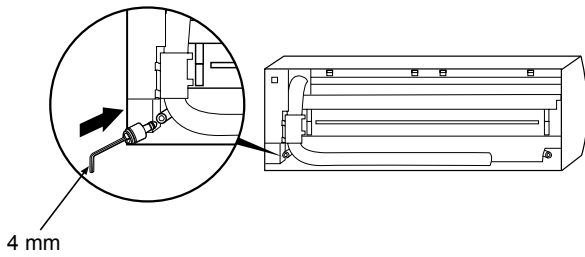

Fig. 10-3-15

2. Firmly insert drain cap.

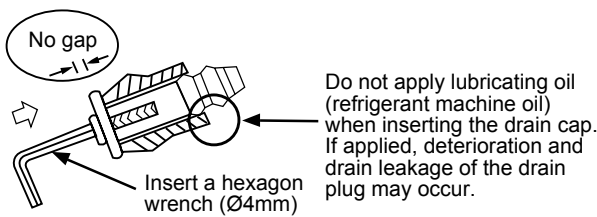

Fig. 10-3-16

<How to attach the drain hose>

Always use the original screw that secured the drain hose to the unit. If using a different screw may cause water to leak.

Insert the drain hose firmly until the connector contacts with the insulation, then secure it in place using the original screw.

Firmly insert the drain hose and drain cap; otherwise, water may leak.

<In case of right or left piping>

- After scribing slits on the front panel with a knife or a making-off pin, cut them with a pair of nippers or an equivalent tool.

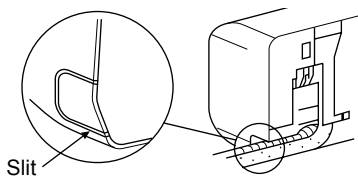

Fig. 10-3-17

<In case of bottom right or bottom left piping>

- After scribing slits of the front panel with a knife or a making-off pin, cut them with a pair of nippers or an equivalent tool.

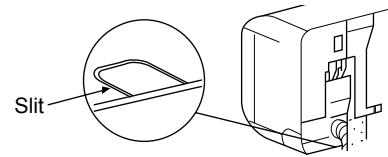

Fig. 10-3-18

<Left-hand connection with piping>

Bend the connecting pipe so that it is laid within 43 mm above the wall surface.

If the connecting pipe is laid exceeding 43 mm above the wall surface, the indoor unit may unstably be set on the wall.

When bending the connecting pipe, make sure to use a spring bender so as not to crush the pipe.

Refer to the table below for the bending radius of each connection pipe.

Outer diameter	Bending radius
Ø6.35 mm	30 mm
Ø12.70 mm, Ø15.88 mm	50 mm

To connect the pipe after installation of the unit (figure)

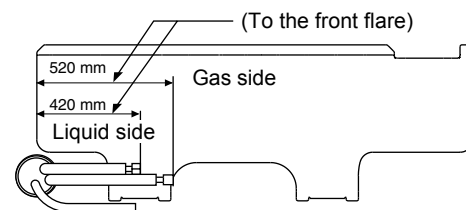

R30 or less (Ø6.35), R50 or less (Ø12.70, Ø15.88)
Use polishing (polyethylene core or the like for bending pipe).

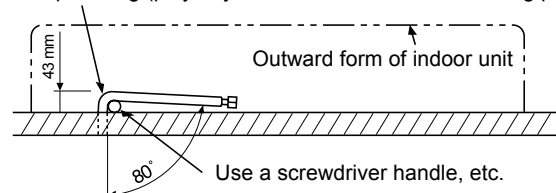

Fig. 10-3-19

NOTE :

If the pipe is bent incorrectly, the indoor unit may unstably be set on the wall.

After passing the connecting pipe through the pipe hole, connect the connecting pipes to the auxiliary pipes and wrap the facing tape around them.

Information

The lower part of indoor unit may float, due to the condition of piping and you cannot fix it to the installation plate. In that case, use the ⑪ screws provided to fix the unit and the installation plate.

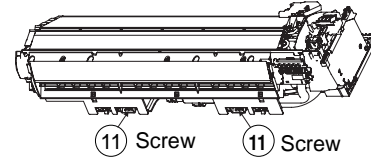

Fig. 10-3-23

- Bind the auxiliary pipes (two) and connecting cable with facing tape tightly.
In case of leftward piping and rear-leftward piping, bind the auxiliary pipes (two) only with facing tape.

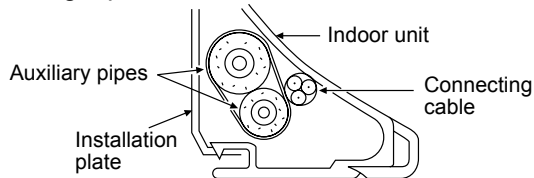

Fig. 10-3-20

- Carefully arrange pipes so that any pipe does not stick out of the rear plate of the indoor unit.
- Carefully connect the auxiliary pipes and connecting pipes to one another and cut off the insulating tape wound on the connecting pipe to avoid double-taping at the joint, moreover, seal the joint with the vinyl tape, etc.
- Since dewing results in a machine trouble, make sure to insulate both connecting pipes. (Use polyethylene foam as insulating material.)
- When bending a pipe, be careful not to crush it.

10-3-6. Indoor Unit Fixing

1. Pass the pipe through the hole in the wall and hook the indoor unit on the installation plate at the upper hook.
2. Swing the indoor unit to right and left to confirm that it is firmly hooked on the installation plate.
3. While pressing the indoor unit onto the wall, hook it at the lower part on the installation plate. Pull the indoor unit toward you to confirm that it is firmly hooked on the installation plate.

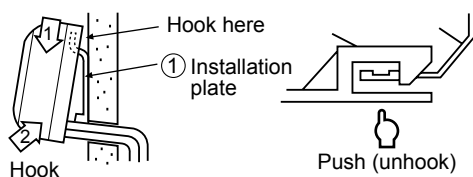

Fig. 10-3-21

- For detaching the indoor unit from the installation plate, pull the indoor unit toward you while pushing its bottom up at the specified parts.

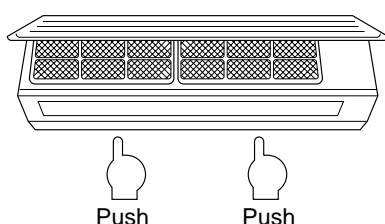

Fig. 10-3-22

10-3-7. Drainage

1. Run the drain hose sloped downwards.

NOTE :

- The hole should be made at a slight downward slant on the outdoor side.

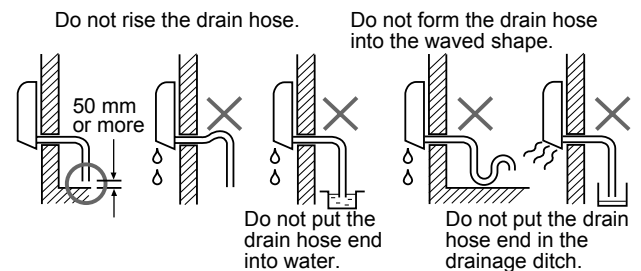

Fig. 10-3-24

2. Put water in the drain pan and make sure that the water is drained out of doors.
3. When connecting extension drain hose, insulate the connection part of extension drain hose with shield pipe.

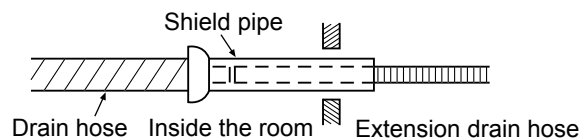

Fig. 10-3-25

Arrange the drain pipe for proper drainage from the unit.
Improper drainage can result in dew-dropping.

This air conditioner has the structure designed to drain water collected from dew, which forms on the back of the indoor unit, to the drain pan.
Therefore, do not store the power cord and other parts at a height above the drain guide.

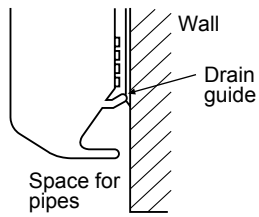

Fig. 10-3-26

10-4. Outdoor Unit

10-4-1. Installation place

- A place which provides the spaces around the outdoor unit as shown in the left diagram.
- A place which can bear the weight of the outdoor unit and does not allow an increase in noise level and vibration.
- A place where the operation noise and discharged air do not disturb your neighbors.
- A place which is not exposed to a strong wind.
- A place free of a leakage of combustible gases.
- A place which does not block a passage.
- When the outdoor unit is to be installed in an elevated position, be sure to secure its feet.
- An allowable length of the connecting pipe up to 20 m.
- There is no need to add refrigerant as long as the length of the connection piping 15 m or less.
- You will need to add 20g of refrigerant per meter of added connection piping for installations requiring connection piping to be between 16 m to 20 m.
- An allowable height level is up to 10 m.
- A place where the drain water does not cause any problems.

10-4-2. Precautions about Installation in Regions with Snowfall and Cold Temperatures

- Do not use the supplied drain nipple for draining water. Drain the water from all the drain holes directly.
- To protect the outdoor unit from snow accumulation, install a holding frame, and attach a snow protection hood and plate.
- Do not use a double-stacked design.

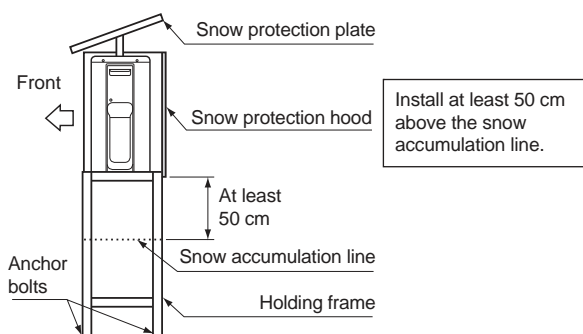

Fig. 10-4-1

1. Install the outdoor unit in a location where there are no obstructions near its air intake or air outlet.
2. When the outdoor unit is installed in a place that is always exposed to strong wind like on the coast or on a high story of a building, secure the normal fan operation using a duct or a wind shield.
3. Especially in windy areas, install the unit to prevent the admission of wind.
4. Installation in the following places may result in trouble.

Do not install the unit in such places.

- A place full of machine oil.
- A saline-place such as the coast.
- A place full of sulfide gas.
- A place where high-frequency waves are likely to be generated, such as from audio equipment, welders, and medical equipment.

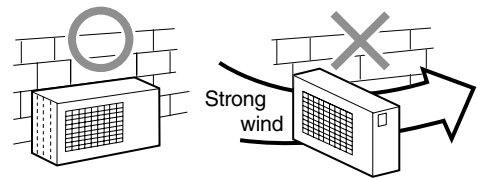

Fig. 10-4-2

10-4-3. Refrigerant piping connection

<Flaring>

1. Cut the pipe with a pipe cutter.

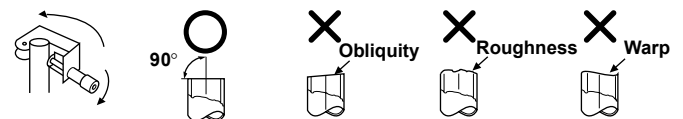

Fig. 10-4-3

2. Insert a flare nut into the pipe, and flare the pipe.
 - Projection margin in flaring : A (Unit : mm)

Rigid (clutch type)

Outer dia. of copper pipe	A	
	Rigid	Imperial
∅ 6.35	0 to 0.5	1.0 to 1.5
∅ 12.70	0 to 0.5	1.0 to 1.5

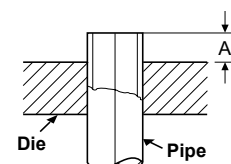

Fig. 10-4-4

Imperial (wing nut type)

Outer dia. of copper pipe	R410A
∅6.35	1.5 to 2.0
CAUTION ∅12.70	2.0 to 2.5

<Tightening connection>

Align the centers of the connecting pipes and tighten the flare nut as far as possible with your fingers. Then tighten the nut with a spanner and torque wrench as shown in the figure.

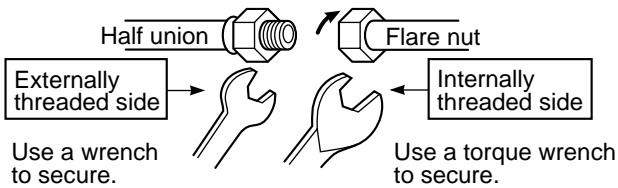

Fig. 10-4-5

- Do not apply excess torque.
- Otherwise, the nut may crack depending on the conditions.

(Unit : N·m)

Outer dia. of copper pipe	Tightening torque
∅6.35	16 to 18 (1.6 to 1.8 kgf·m)
∅12.70	50 to 62 (5.0 to 6.2 kgf·m)

<Tightening orque of flare pipe connections>

The operating oressure of R410A is higher than that of R22 (approx. 1.6 times). It is therefore necessary to firmly tighten the flare pipe connecting sections (which connect the indoor and outdoor units) up to the specified tightening torque. Incorrect connections may cause not only a gas leakage, but also damage to the refrigeration cycle.

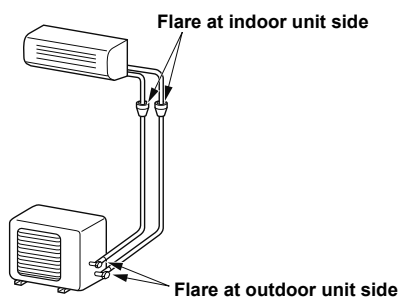

Fig. 10-4-6

10-4-4. Evacuating

After the piping has been connected to the indoor unit, you can perform the air purge together at once.

AIR PURGE
Evacuate the air in the connecting pipes and in the indoor unit using a vacuum pump. Do not use the refrigerant in the outdoor unit.
For details, see the manual of the vacuum pump.

<Using a vacuum pump>

Be sure to use a vacuum pump with counter-flow prevention function so that inside oil of the pump does not flow backward into pipes of the air conditioner when the pump stops.

(If oil inside of the vacuum pump enters the air conditioner, which use R410A, refrigeration cycle trouble may happen.)

1. Connect the charge hose from the manifold valve to the service port of the packed valve at gas side.
2. Connect the charge hose to the port of the vacuum pump.
3. Open fully the low pressure side handle of the gauge manifold valve.
4. Operate the vacuum pump to start evacuating. Perform evacuating for about 15 minutes if the piping length is 20 meters. (15 minutes for 20 meters) (assuming a pump capacity of 27 liters per minute.) Then confirm that the compound pressure gauge reading is -101 kPa (-76 cmHg).
5. Close the low pressure side valve handle of the gauge manifold valve.
6. Open fully the valve stem of the packed valves (both gas and liquid sides).
7. Remove the charging hose from the service port.
8. Securely tighten the caps on the packed valves.

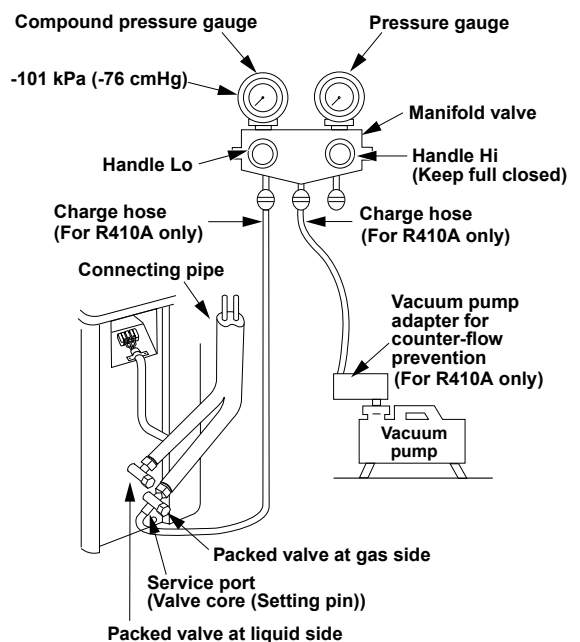

Fig. 10-4-7

KEEP IMPORTANT 5 POINTS FOR PIPING WORK

- (1) Take away dust and moisture (Inside of the connecting pipes.)
- (2) Tight the connection (between pipes and unit)
- (3) Evacuate the air in the connecting pipes using a VACUUM PUMP.
- (4) Check gas leak (connected points)
- (5) Be sure to fully open the packed valves before operation.

<Packed valve handling precautions>

- Open the valve stem all the way out, but do not try to open it beyond the stopper.

Pipe size of Packed Valve	Size of Hexagon wrench
12.70 mm and smaller	A = 4 mm
15.88 mm	A = 5 mm

- Securely tighten the valve cap with torque in the following table

Cap	Cap Size (H)	Torque
Valve Rod Cap	H17 - H19	14~18 N.m (1.4 to 1.8 kgf·m)
	H22 - H30	33~42 N.m (3.3 to 4.2 kgf·m)
Service Port Cap	H14	8~12 N.m (0.8 to 1.2 kgf·m)
	H17	14~18 N.m (1.4 to 1.8 kgf·m)

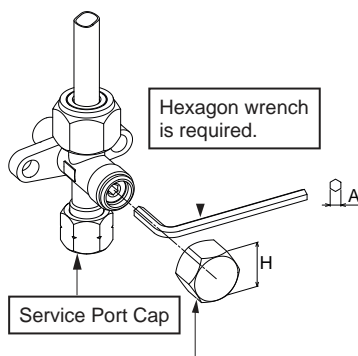

Fig. 10-4-8

10-4-5. Wiring connection

1. Remove the valve cover, the electric parts cover and the cord clamp from the outdoor unit.
2. Connect the connecting cable to the terminal as identified by the matching numbers on the terminal block of indoor and outdoor unit.
3. Insert the power cord and the connecting cable carefully into the terminal block and secure it tightly with screws.
4. Use vinyl tape, etc. to insulate the cords which are no going to be used. Locate them so that they do not touch any electrical or metal parts.
5. Secure the power cord and the connecting cable with the cord clamp.
6. Attach the electric parts cover and the valve cover on the outdoor unit.

10-4-5. Electrical Work

1. The supply voltage must be the same as the rated voltage of the air conditioner.
2. Prepare the power source for exclusive use with the air conditioner.

NOTE

- Wire type : More than H07RN-F or 60245 IEC66 (1.5 mm² or more)

<Stripping length of the connecting cable>

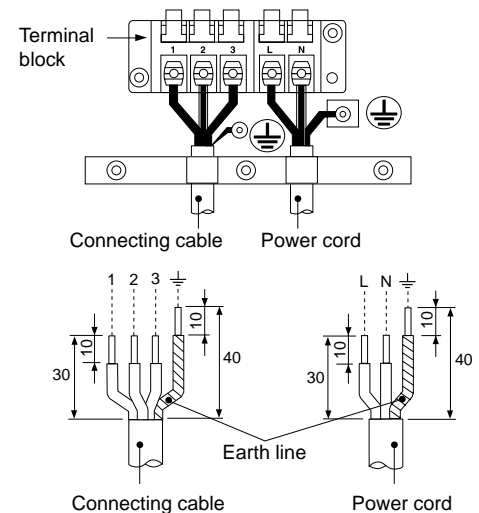

Fig. 10-4-9

Model	18 Class	22 Class
Power source	220 - 240V Single phase, 50Hz 220V Single phase, 60Hz	
Maximum running current	10.0A	13.5A
Plug socket & fuse rating	16A	16A
Power cord	H07RN-F or 60245 IEC66 (1.5 mm ²)	
Connecting cable	H07RN-F or 60245 IEC66 (1.0 mm ²)	

CAUTION

- Wrong wiring connection may cause some electrical parts burn out.
- Be sure to comply with local cords on running the wire from indoor unit to outdoor unit (size of wire and wiring method, etc.).
- Every wire must be connected firmly.
- This installation circuit breaker must be used specified for the power supply line of this air conditioner.
- If incorrect or incomplete wiring is carried out, it will cause an ignition or smoke.
- Prepare the power supply for exclusive use with the air conditioner.
- This product can be connected to the mains.
Connection to fixed wiring: A switch which disconnects all poles and has a contact separation of at least 3 mm must be incorporated in the fixed wiring

10-5. Others

10-5-1. Gas leak test

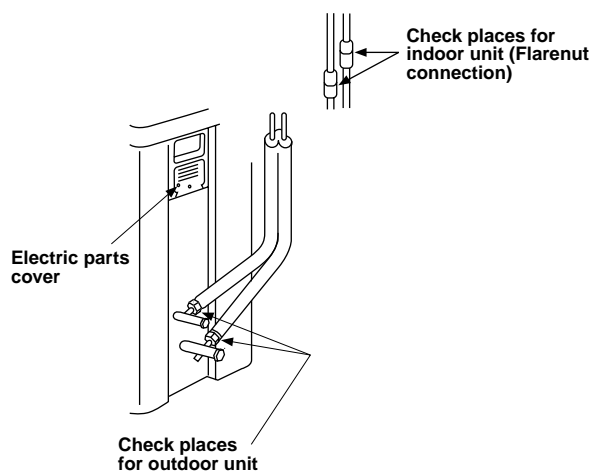

Fig. 10-5-1

- Check the flare nut connections for the gas leak with a gas leak detector or soap water.

10-5-2. Remote Control A-B Selection

- When two indoor units are installed in the same room or adjacent two rooms, if operating a unit, two units may receive the remote control signal simultaneously and operate. In this case, the operation can be preserved by setting either one remote control to B setting. (Both are set to A setting in factory shipment.)
- The remote control signal is not received when the settings of indoor unit and remote control are different.
- There is no relation between A setting/B setting and A room/B room when connecting the piping and cables.

<Remote control A-B selection>

To separate using of remote control for each indoor unit in case of 2 air conditioners are installed nearby.

<Remote Control B Setup>

1. Press [RESET] button on the indoor unit to turn the air conditioner ON.
2. Point the remote control at the indoor unit.
3. Push and hold [CHECK] button on the Remote Control by the tip of the pencil. "00" will be shown on the display (Picture ①).
4. Press [MODE] during pushing [CHECK]. "B" will show on the display and "00" will disappear and the air conditioner will turn OFF. The Remote Control B is memorized (Picture ②).

- NOTE :**
1. Repeat above step to reset Remote Control to be A.
 2. Remote Control A has not "A" display.
 3. Default setting of Remote Control from factory is A.

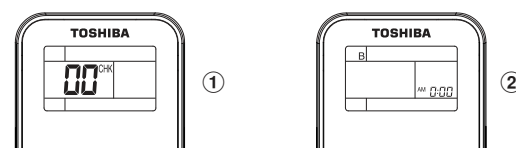

Fig. 10-5-2

10-5-3. Test operation

To switch the TEST RUN (COOL) mode, press [RESET] button for 10 sec.
(The beeper will make a short beep.)

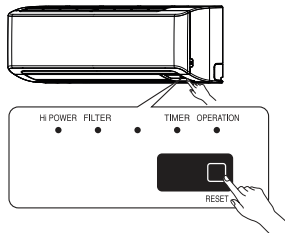

Fig. 10-5-3

10-5-4. Auto restart setting

This product is designed so that, after a power failure, it can restart automatically in the same operating mode as before the power failure.

The product was shipped with Auto Restart function in the off position. Turn it on as required.

<How to set the auto restart>

1. Press and hold the [RESET] button on the indoor unit 3 seconds to set the operation. (3 beep sound and OPERATION lamp blink 5 time/sec for 5 seconds)
2. Press and hold the [RESET] button on the indoor unit for 3 seconds to cancel the operation. (3 beep sound but OPERATION lamp does not blink)
 - In case of ON timer or OFF timer are set, AUTO RESTART OPERATION dose not activate.

11. HOW TO DIAGNOSE THE TROUBLE

The pulse motor circuits are mounted to both indoor and outdoor units.

Therefore, diagnose troubles according to the trouble diagnosis procedure as described below.

(Refer to the check points in servicing written on the wiring diagrams attached to the indoor/outdoor units.)

Table 11-1

No.	Troubleshooting Procedure
1	First Confirmation
2	Primary Judgment
3	Judgment by Flashing LED of Indoor Unit
4	Self-Diagnosis by Remote Controller (Check Code)
5	Judgment of Trouble by Every Symptom
6	Check Code 18 and 1E
7	Troubleshooting
8	How to Diagnose Trouble in Outdoor Unit
9	How to Check Simply the Main Parts
10	How to Simply Judge Whether Outdoor Fan Motor is Good or Bad

◆ Precautions when handling the new inverter (3DV Inverter)

⚠ CAUTION: HIGH VOLTAGE

The high voltage circuit is incorporated.

Be careful to do the check service, as the electric shock may be caused in case of touching parts on the P.C. board by hand.

The new inverter (3DV inverter) will be incorporated starting with this unit.

(3DV: 3-shunt Discrete Vector control)

◆ The control circuitry has an uninsulated construction.

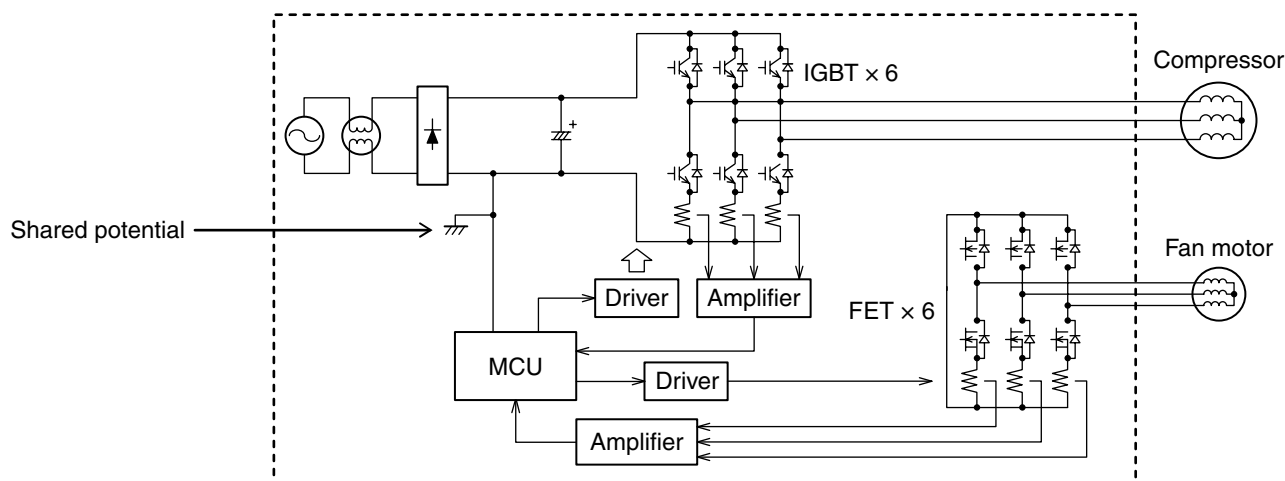

Fig. 11-1

⚠ CAUTION

A high voltage (equivalent to the supply voltage) is also energized to ground through the sensors, PMV and other low-voltage circuits.

The sensor leads and other wires are covered with insulated tubes for protection.

Nevertheless, care must be taken to ensure that these wires are not pinched.

Take sufficient care to avoid directly touching any of the circuit parts without first turning off the power. At times such as when the circuit board is to be replaced, place the circuit board assembly in a vertical position.

Laying the board flat on an electrically conductive object (such as the top panel of the air conditioner's outdoor unit) while a charge is still retained by the electrolytic capacitors of the inverter's main circuit may cause short-circuiting between the electrolytic capacitors and secondary circuit components and result in damage to the components.

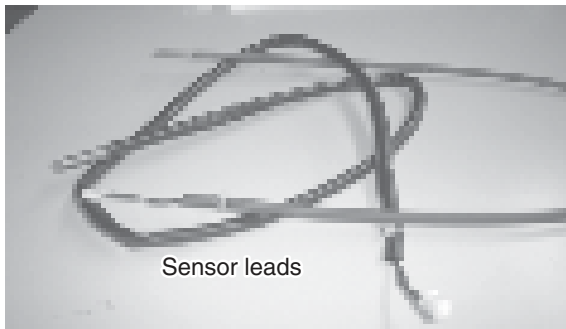

Sensor leads

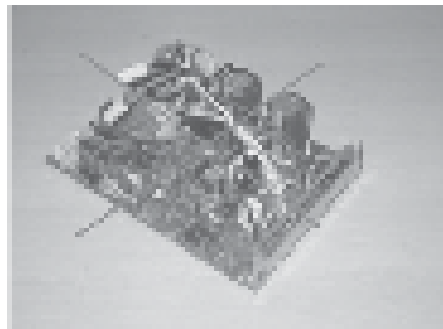

Fig. 11-2

Do NOT lay the circuit board assembly flat.

◆ Precautions when inspecting the control section of the outdoor unit

NOTE :

A large-capacity electrolytic capacitor is used in the outdoor unit controller (inverter). Therefore, if the power supply is turned off, charge (charging voltage DC280 to 380V) remains and discharging takes a lot of time.

After turning off the power source, if touching the charging section before discharging, an electrical shock may be caused. Discharge the electrolytic capacitor completely by using soldering iron, etc.

< Discharging method >

1. Remove the inverter cover (plating) by opening 4 mounting claws.
2. As shown below, connect the discharge resistance (approx. 100Ω, 40W) or plug of the soldering iron to voltage between + – terminals of the C14 ("CAUTION HIGH VOLTAGE" is indicated.) electrolytic capacitor (500μF / 400V) or (760μF / 400V) on P.C. board, and then perform discharging.

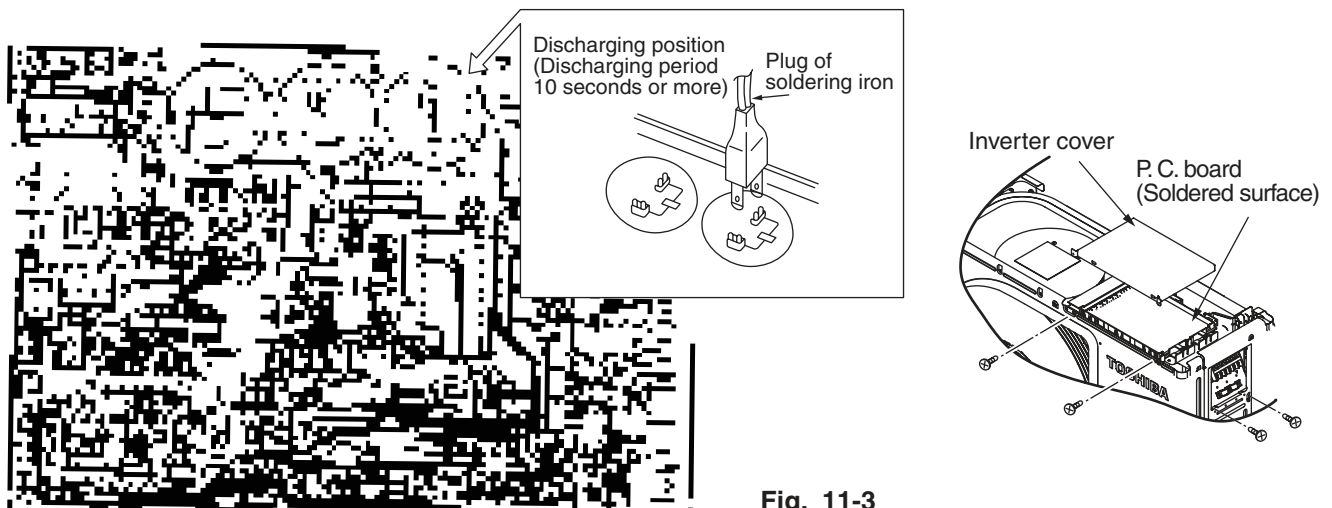

Fig. 11-3

11-1. First Confirmation

11-1-1. Confirmation of Power Supply

Confirm that the power breaker operates (ON) normally.

11-1-2. Confirmation of Power Voltage

Confirm that power voltage is AC 220–230–240 ± 10%.

If power voltage is not in this range, the unit may not operate normally.

11-1-3. Operation Which is not a Trouble (Program Operation)

For controlling the air conditioner, the program operations are built in the microcomputer as described in the following table.

If a claim is made for running operation, check whether or not it meets to the contents in the following table.

When it does, we inform you that it is not trouble of equipment, but it is indispensable for controlling and maintaining of air conditioner.

Table 11-1-1

No.	Operation of air conditioner	Description
1	When power breaker is turned "ON", the operation indicator (Green) of the indoor unit flashes.	The OPERATION lamp of the indoor unit flashes when power source is turned on. If [⏻] button is operated once, flashing stops. (Flashes also in power failure)
2	Compressor may not operate even if the room temperature is within range of compressor-ON.	The compressor does not operate while compressor restart delay timer (3-minutes timer) operates. The same phenomenon is found after power source has been turned on because 3-minutes timer operates.
3	In Dry and ECO mode, FAN (air flow) display does not change even though FAN (air flow select) button is operated.	The air flow indication is fixed to [AUTO].
4	Increasing of compressor motor speed stops approx. 30 seconds after operation started, and then compressor motor speed increases again approx. 30 seconds after.	For smooth operation of the compressor, the compressor motor speed is restricted to Max. 41 rps for 2 minutes, and Max.91 rps for 2 minutes to 3 minutes, respectively after the operation has started.
5	In AUTO mode, the operation mode is changed.	After selecting Cool or Heat mode, select an operation mode again if the compressor keeps stop status for 15 minutes.
6	In HEAT mode, the compressor motor speed does not increase up to the maximum speed or decreases before the temperature arrives at the set temperature.	The compressor motor speed may decrease by hightemp. release control (Release protective operation by temp.-up of the indoor heat exchanger) or current release control.

11-2. Primary Judgment

To diagnose the troubles, use the following methods.

- 1) Judgment by flashing LED of indoor unit
- 2) Self-diagnosis by service check remote controller
- 3) Judgment of trouble by every symptom

Firstly use the method 1) for diagnosis. Then, use the method 2) or 3) to diagnose the details of troubles.

11-3. Judgment by Flashing LED of Indoor Unit

While the indoor unit monitors the operation status of the air conditioner, if the protective circuit operates, the contents of self-diagnosis are displayed with block on the indoor unit indication section.

Table 11-3-1

	Item	Check code	Block display	Description for self-diagnosis
<div style="border: 1px solid black; padding: 5px; width: fit-content;">Indoor indication lamp flashes.</div> <div style="margin: 5px 0;">↓</div> <div style="border: 1px solid black; padding: 5px; width: fit-content;">Which lamp does flash?</div> <div style="margin: 5px 0;">↓</div> <div style="border: 1px solid black; padding: 5px; width: fit-content;">C</div>	A	—	OPERATION (Green) Flashing display (1 Hz)	<ul style="list-style-type: none"> When turn ON power supply. Power supply ON after failure or OFF. This flashing display is not air conditioner failure.
	B	00	OPERATION (Green) Flashing display (5 Hz)	Protective circuit operation for indoor P.C. board
	C	01	OPERATION (Green) TIMER (Yellow) Flashing display (5 Hz)	Protective circuit operation for connecting cable and serial signal system
	D	02	OPERATION (Green) FILTER (Orange) Flashing display (5 Hz)	Protective circuit operation for outdoor P.C. board
	E	03	OPERATION (Green) TIMER (Yellow) FILTER (Orange) Flashing display (5 Hz)	Protective circuit operation for others (including compressor)

NOTES :

1. Some check code will flash display of the indoor unit, when the air conditioner operates with some limitation.
2. Some check code will flash display of the indoor unit and stop operation of the air conditioner.
3. When item B and C or item B and apart of item E occur concurrently, priority is given to the block of item B.
4. The check codes can be confirmed on the remote controller for servicing.

11-4. Self-Diagnosis by Remote Controller (Check Code)

1. If the lamps are indicated as shown B to E in Table 11-3-1, execute the self-diagnosis by the remote controller.
2. When the remote controller is set to the service mode, the indoor controller diagnoses the operation condition and indicates the information of the self-diagnosis on the display of the remote controller with the check codes. If a fault is detected, all lamps on the indoor unit will flash at 5Hz and it will beep for 10 seconds (Beep, Beep, Beep ...). The timer lamp usually flashes (5Hz) during self-diagnosis.

11-4-1. How to Use Remote Controller in Service Mode

1 Press [CHECK] button with a tip of pencil to set the remote controller to the service mode.

- "00" is indicated on the display of the remote controller.

2 Press [ON ▲] or [OFF ▲] button

If there is no fault with a code, the indoor unit will beep once (Beep) and the display of the remote controller will change as follows :

00 → 01 → 02 ... 1d → 1E → 33

- The TIMER indicator of the indoor unit flashes continuously. (5 times per 1 sec.)
- Check the unit with all 52 check codes (00 to 33) as shown in Table-11-3-1.
- Press [ON ▼] or [OFF ▼] button to change the check code backward.

If there is a fault, the indoor unit will beep for 10 seconds (Beep, Beep, Beep...).

Note the check code on the display of the remote controller.

- 2-digits alphanumeric will be indicated on the display.
- All indicators on the indoor unit will flash. (5 times per 1 sec.)

3 Press [CLR] button. After service finish for clear service code in memory.

- "7F" is indicated on the display of the remote control.

4 Press [⏻] button to release the service mode.

- The display of the remote controller returns to as it was before service mode was engaged.

Alphanumeric characters are used for the check codes.

5 is 5.	6 is 6.
A is A.	B is B.
C is C.	D is D.

Fig. 9-4-1

11-4-2 Caution at Servicing

1. After using the service mode of remote controller finished, press the [\odot] button to reset the remote controller to normal function.
2. After finished the diagnosis by the remote controller, turn OFF power supply and turn its ON again to reset the air conditioner to normal operation. However, the check codes are not deleted from memory of the microcomputer.
3. After servicing finished, press [CLR] button of remote controller under service mode status to send code "7F" to the indoor unit. The check code stored in memory is cleared.

Table 11-4-1

Block distinction		Operation of diagnosis function				Action and Judgment
Check code	Block	Check code	Cause of operation	Air conditioner status	Display flashing error	
00	Indoor P.C. board.	0C	TA sensor ; The room temperature sensor is short-Circuit or disconnection.	Operation continues.	Flashes when error is detected.	1. Check the sensor TA and connection. 2. In case of the sensor and its connection is normal, check the P.C. board.
		0d	TC sensor ; The heat exchanger temperature sensor of the indoor unit is out of place, disconnection, short-circuit or migration.	Operation continues.	Flashes when error is detected.	1. Check the sensor TC and connection. 2. In case of the sensor and its connection is normal, check the P.C. board.
		11	Fan motor of the indoor unit is failure, lock-rotor, short-circuit, disconnection, etc. Or its circuit on P.C. board has problem.	All OFF	Flashes when error is detected.	1. Check the fan motor and connection. 2. In case of the motor and its connection is normal, check the P.C. board.
		12	Other trouble on the indoor P.C. board.	Depend on cause of failure.	Depend on cause of failure.	Replace P.C. board.

Block distinction		Operation of diagnosis function				Action and Judgment
Check code	Block	Check code	Cause of operation	Air conditioner status	Display flashing error	
01	Serial signal and connecting cable.	04	1) Defective wiring of the connecting cable or miss-wiring. 2) Operation signal has not send from the indoor unit when operation start. 3) Outdoor unit has not send return signal to the indoor unit when operation started. 4) Return signal from the outdoor unit is stop during operation. <ul style="list-style-type: none"> • Some protector (hardware, if exist) of the outdoor unit open circuit of signal. • Signal circuit of indoor P.C. board or outdoor P.C. board is failure in some period. 	Indoor unit operates continue. Outdoor unit stop.	Flashes when error is detected. Flashing stop and outdoor unit start to operate when the return signal from the outdoor unit is normal.	1) to 3) The outdoor unit never operate. <ul style="list-style-type: none"> • Check connecting cable and correct if defective wiring. • Check 25A fuse of inverter P.C. board. • Check 3.15A fuse of inverter P.C. board. • Check operation signal of the indoor unit by using diode. Measure voltage at terminal block of the indoor unit between No.2 and No.3 (or L2 and S) If signal is varied 15-60V continuously, replace inverter P.C. board. If signal is not varied, replace indoor P.C. board. 4) The outdoor unit abnormal stop at some time. <ul style="list-style-type: none"> • If the other check codes are found concurrently, check them together. • Check protector (hardware) such as Hi-Pressure switch, Thermal-Relay, etc. • Check refrigerant amount or any possibility case which may caused high temperature or high pressure. • Check operation signal of the indoor unit by using diode. Measure voltage at terminal block of the indoor unit between No.2 and No.3 (or L2 and S) If signal is varied 15-60V continuously, replace inverter P.C. board. If signal is not varied, replace indoor P.C. board.

Note : Operation signal of the indoor unit shall be measured in the sending period as picture below.

Sending signal of the indoor unit when have not return signal from the outdoor unit.

* Signal send only 1 minute and stop. Because of return signal from outdoor unit has not received.
 ** Signal resend again after 3 minutes stop. And the signal will send continuously.
 *** 1 minute after resending, the indoor unit display flashes error.

Block distinction		Operation of diagnosis function				Judgment and action
Check code	Block	Check code	Cause of operation	Air conditioner status	Remarks	
02	Outdoor P.C. board	14	Inverter over-current protective circuit operates. (Short time)	All off	Displayed when error is detected.	Even if trying operation again, all operations stop immediately. : Replace P.C. board.
		16	Position-detect circuit error or short-circuit between windings of compressor	All off	Displayed when error is detected.	1. Even if connecting lead wire of compressor is removed, position-detect circuit error occurred. : Replace P.C. board. 2. Measure resistance between wires of compressor, and perform short-circuit. : Replace compressor.
		17	Current-detect circuit error	All off	Displayed when error is detected.	Even if trying operation again, all operations stop immediately. : Replace P.C. board.
		18	Being out of place, disconnection or shortcircuit of the outdoor heat exchanger sensor (TE) or suction temp. sensor (Ts)	All off	Displayed when error is detected.	1. Check sensors (TE, TS). 2. Check P.C. board.
		19	Disconnection or shortcircuit of discharge temp. sensor	All off	Displayed when error is detected.	1. Check discharge temp. sensor (TD). 2. Check P.C. board
		1A	Outdoor fan drive system error	All off	Displayed when error is detected.	Position-detect error, over-current protective operation of outdoor fan drive system, fan lock, etc. : Replace P.C. board or fan motor.
	Not displayed	1D	Outdoor heat exchanger temp. sensor error	Operation continues	—	1. Check outdoor temp. sensor (TO). 2. Check P.C. board.
Outdoor P.C. board	1E	Compressor drive output error, Compressor error (lock, missing, etc.)	All off	Displayed when error is detected.	When 20 seconds passed after start-up, position-detect circuit error occurred. : Replace compressor. Trouble on PMV	
03	Others (including compressor)	07	Return serial signal has been sent when operation started, but it is not sent from halfway. 1) Compressor thermo. operation Gas shortage Gas leak 2) Instantaneous power failure	Operation continues	Flashes when trouble is detected on return serial signal, and normal status when signal is reset.	1. Repeat Start and Stop with interval of approx. 10 to 40 minutes. (Code is not displayed during operation.) Supply gas. (Check also gas leak). 2. Unit operates normally during check. If return serial signal does not stop between indoor terminal block 2 and 3, replace inverter P.C. board. If signal stops between indoor terminal block 2 and 3, replace indoor P.C. board.
		1D	Compressor does not rotate.(Current protective circuit does not operate when a specified time passed after compressor had been activated.)	All off	Displayed when error is detected.	1. Trouble on compressor 2. Trouble on wiring of compressor (Missed phase)
		1E	Discharge temp. exceeded 117°C	All off	Displayed when error is detected.	1. Check discharge temp. sensor (TD). 2. Gas leakage 3. Trouble on PMV
		1F	Break down of compressor	All off	Displayed when error is detected.	1. Check power voltage. (220–230–240 V +10%) 2. Overload operation of refrigeration cycle Check installation condition (Short-circuit of outdoor diffuser).
		08	4-way valve inverse error (TC sensor value lowered during heating operation.)	Operation continues	—	1. Check 4-way valve operation.

11-5. Judgement of Trouble by Every Symptom

11-5-1. Indoor unit (Including remote controller)

(1) Indoor unit is not operated.

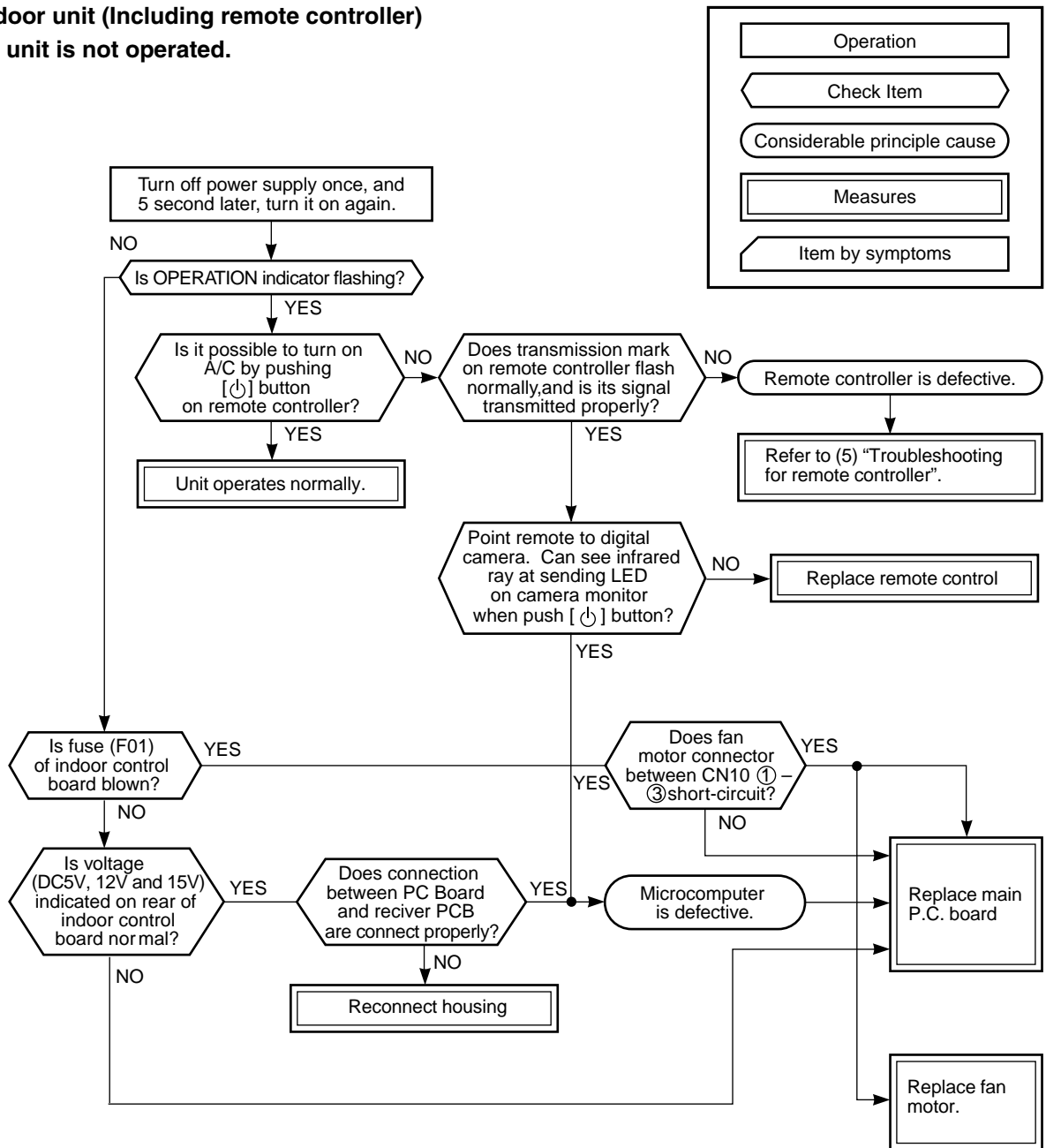

(2) Operation is not turned on though Indoor P.C. board is replaced

<Confirmation procedure>

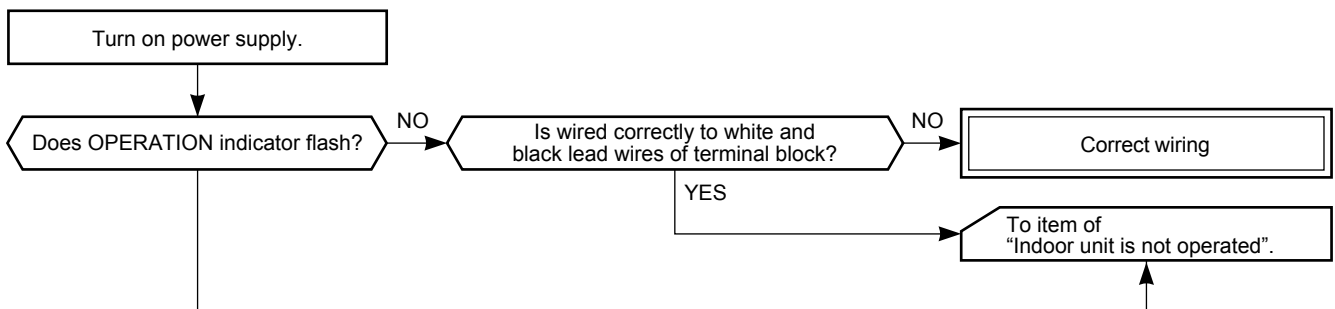

(3) Only the indoor motor fan does not operate

<Primary check>

1. Is it possible to detect the power supply voltage (AC220–240V) between ① and ② on the terminal block?
2. Does the indoor fan motor operate in cooling operation?
(In heating operation, the indoor fan motor does not operate for approximately 10 minutes after it is turned on, to prevent a cold air from blowing in.)

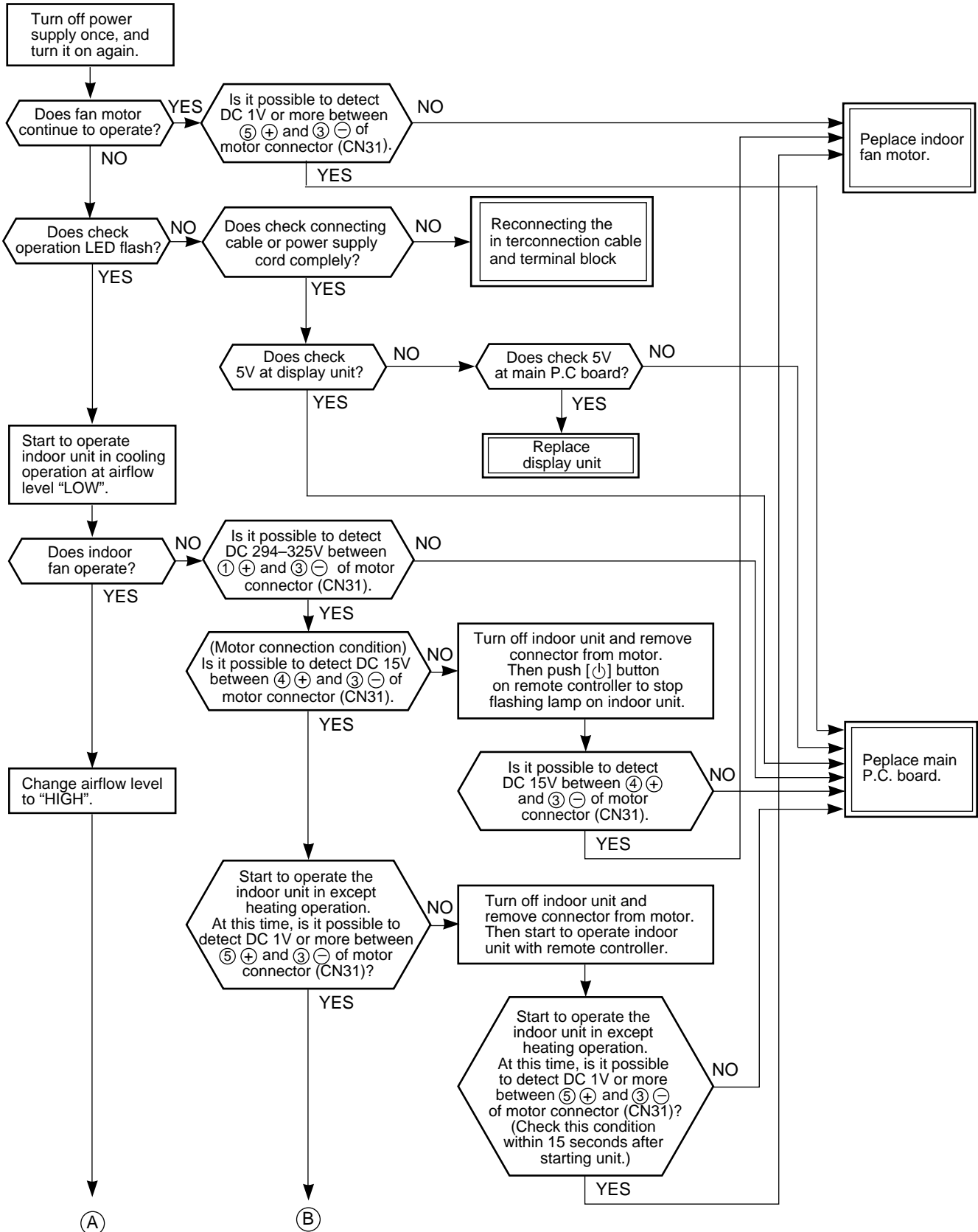

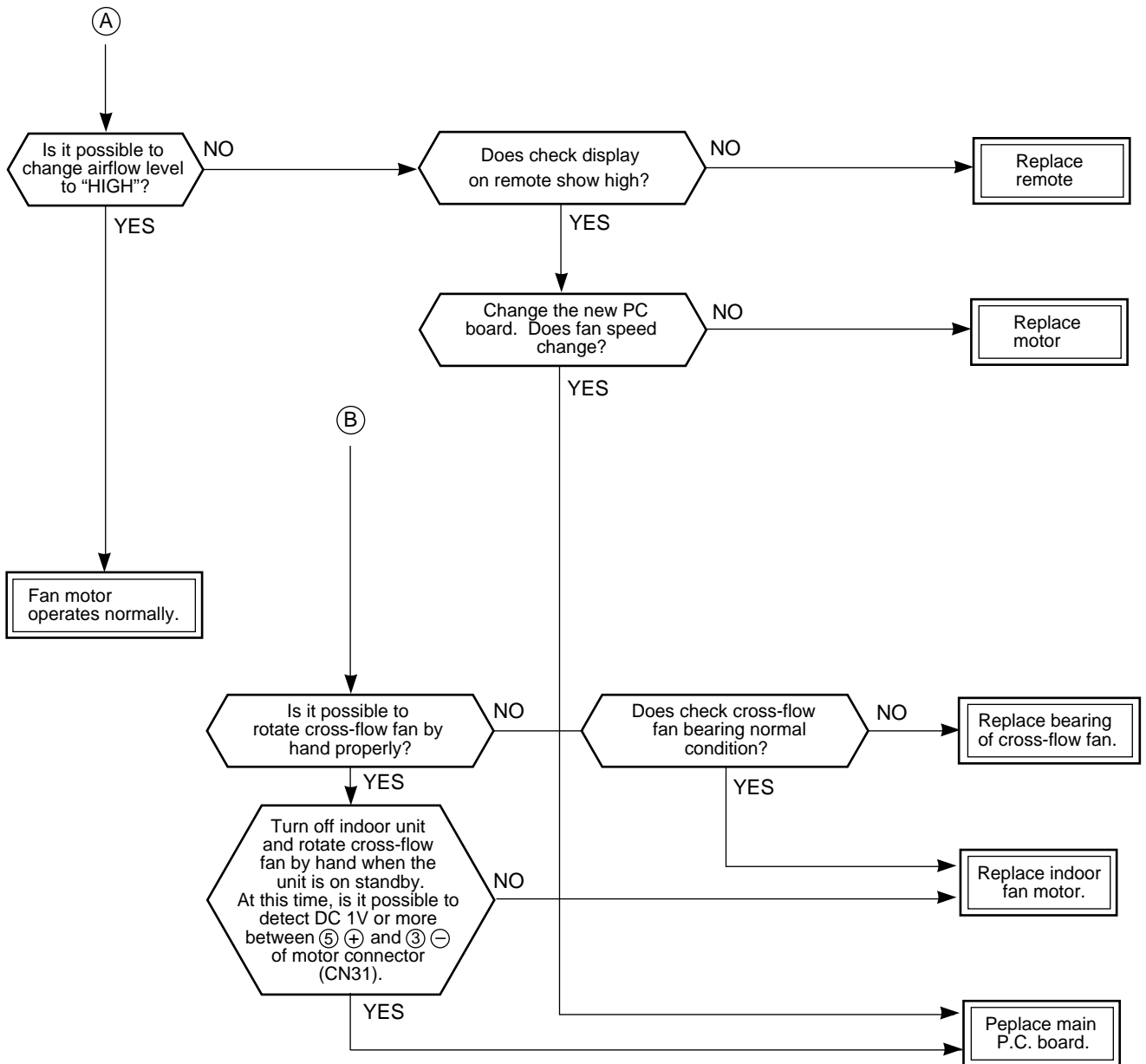

(4) Indoor fan motor automatically starts to rotate by turning on power supply

<Cause>

The IC is built in the indoor fan motor. Therefore the P.C. board is also mounted to inside of the motor.

If the P.C. board is soldered imperfectly or the IC is defective, the fan motor may automatically rotate by turning on power supply.

<Inspection procedure>

1. Turn on breaker.
2. After Fan motor operate, off A/C by remote controller.
3. Turn off breaker for a while, then turn it ON.
 - 3.1. If fan motor not operate, it means an unit in Auto-restart operation. (see more detail in P. 50-51)
 - 3.2. If Fan motor still operate, follow the below.
 - 3.2.1. Remove the grille.
 - 3.2.2. Remove the cover terminal by release one screw.
 - 3.2.3. Check DC voltage with CN31 connector while the fan motor is rotating.

NOTE :

- Do not disconnect the connector while the fan motor is rotating.
- Use a thin test rod.

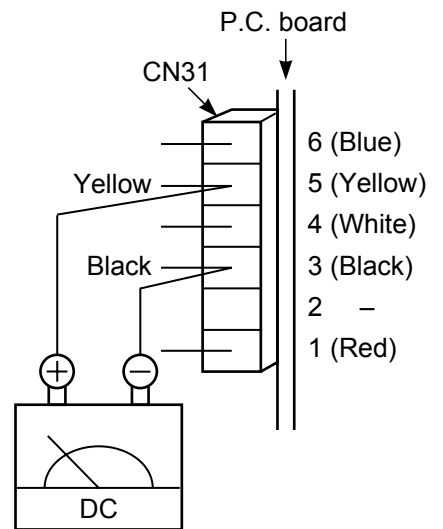
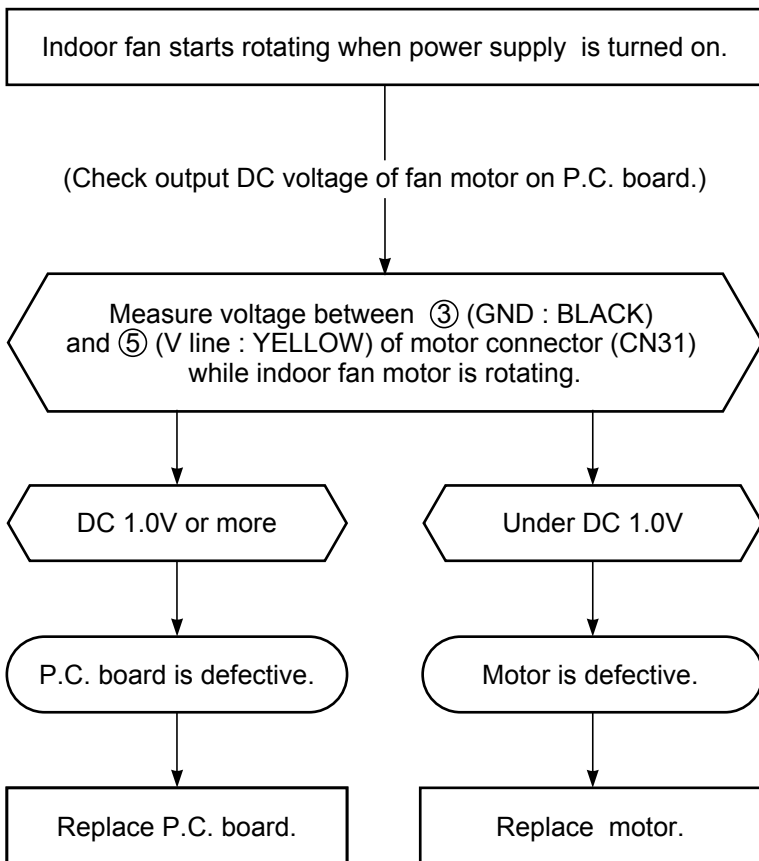

(5) Troubleshooting for remote controller

<Primary check>

Check that A or B selected on the main unit is matched with A or B selected on the remote controller.

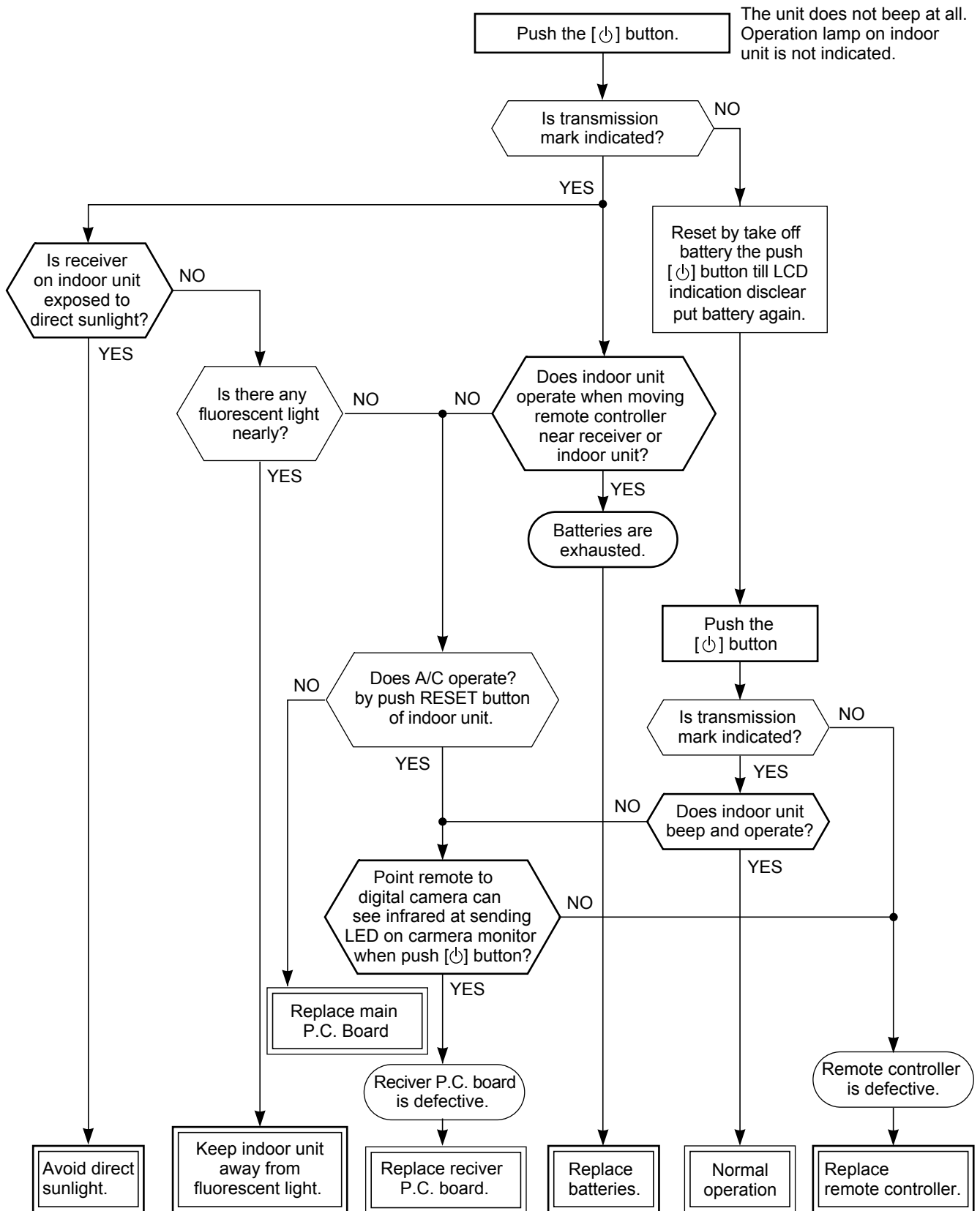

11-5-2. Wiring Failure (Interconnecting and Serial Signal Wire)

(1) Outdoor unit does not operate

1) Is the voltage between ② and ③ of the indoor terminal block varied?

Confirm that transmission from indoor unit to outdoor unit is correctly performed based upon the following diagram.

NOTE:

- Measurement should be performed 2 minutes and 30 seconds after starting of the operation.
- Be sure to prepare a diode for judgment.

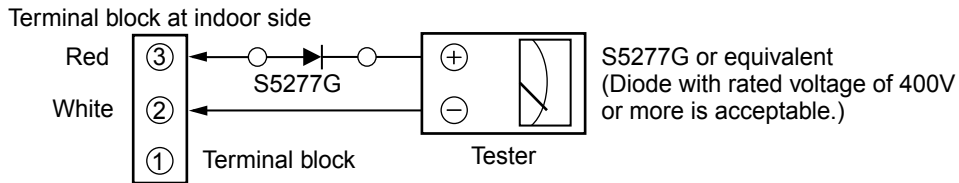

Normal time : Voltage swings between DC15 and 60V. Inverter Assembly check (11-5-1.)

Abnormal time : Voltage does not vary.

(2) Outdoor unit stops in a little while after operation started

<Check procedure> Select phenomena described below.

1) The outdoor unit stops 10 to 20 minutes after operation started, and 10 minutes or more are required to restart the unit.

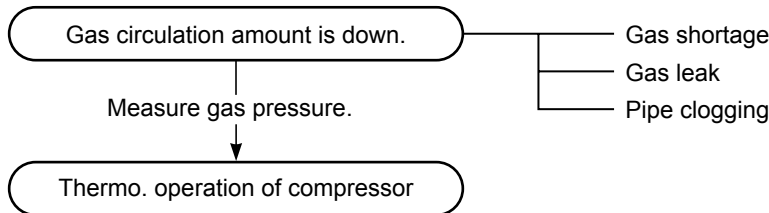

2) If the unit stops once, it does not operate until the power will be turned on again.

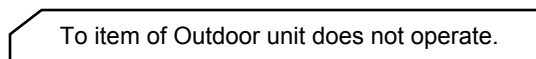

3) The outdoor unit stops 10 minutes to 1 hour after operation started, and an alarm is displayed. (Discharge temp. error check code 03, 1E Sensor temp. error check code 02, 1C)

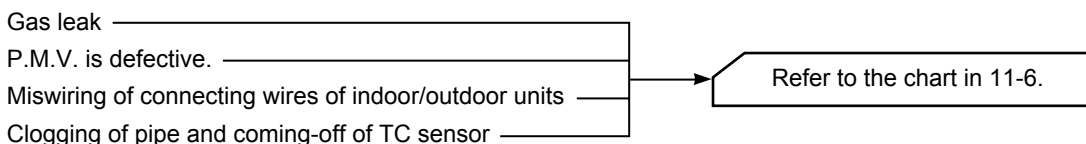

11-6. Check Code 1C (Miswiring in indoor/outdoor units) and 1E

<Check procedure>

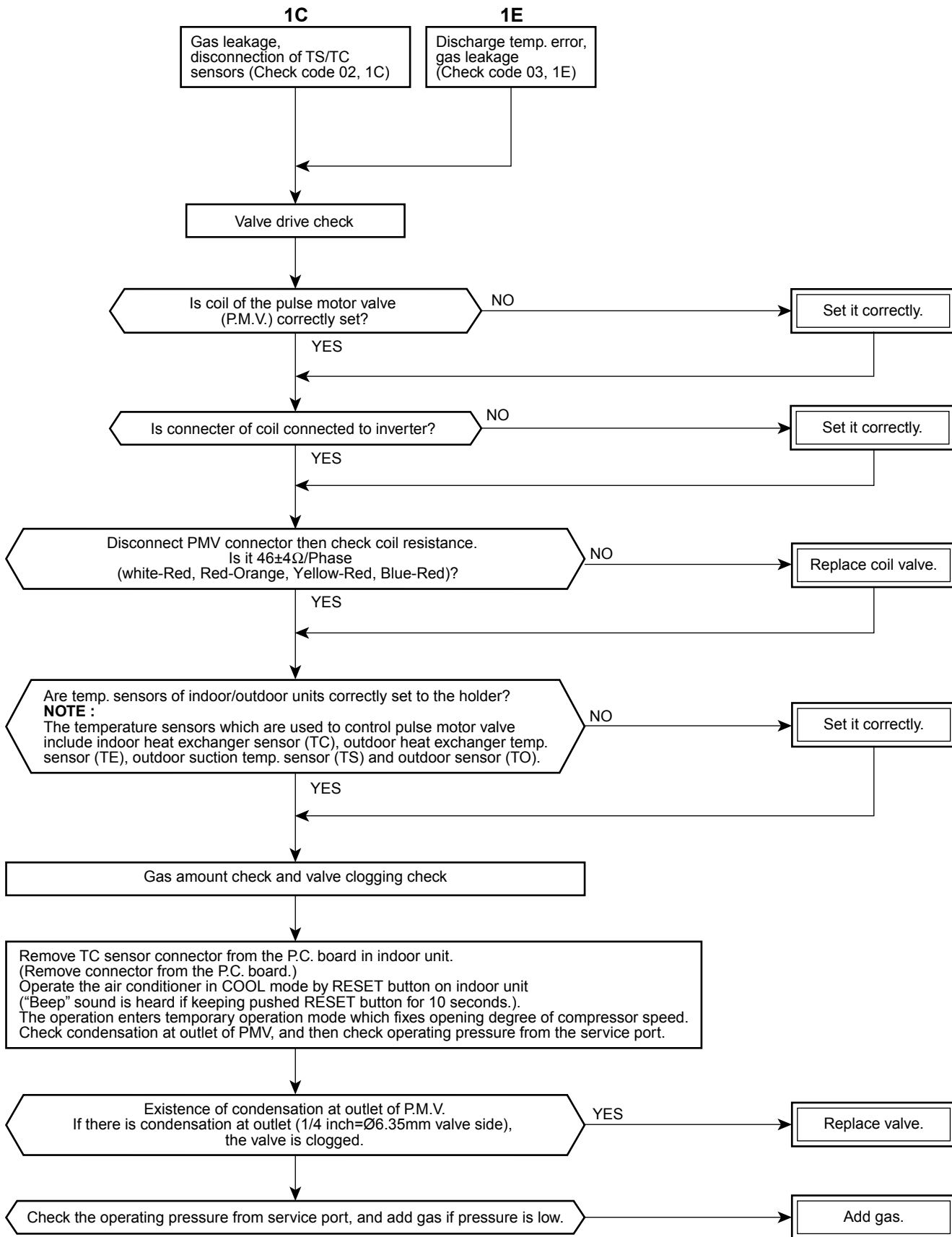

11-7. How to Diagnose Trouble in Outdoor Unit

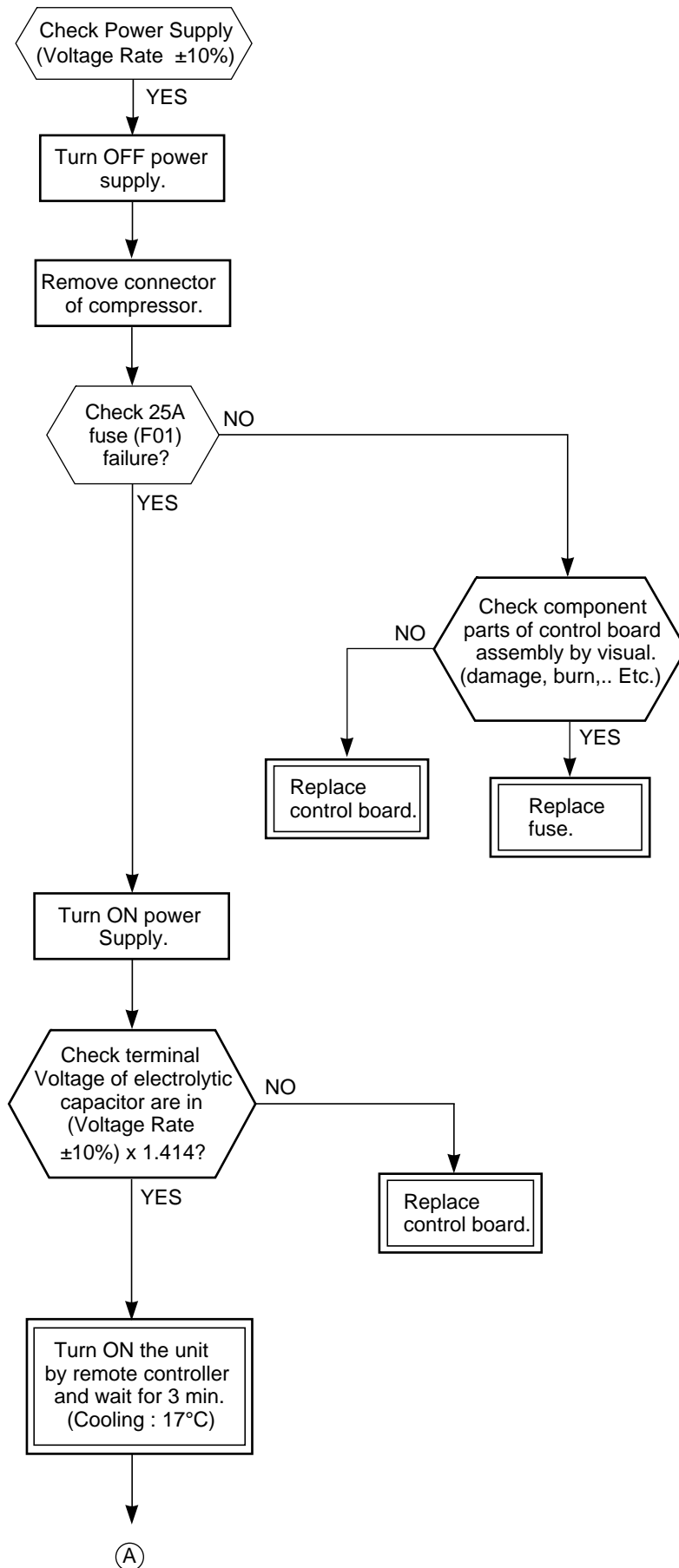

- Connect discharge resistance (approx. 100Ω 40W) or soldering iron (plug) between +, - terminals of the electrolytic capacitor (500μF) of C14 (with printed CAUTION HIGH VOLTAGE) on P.C. board.

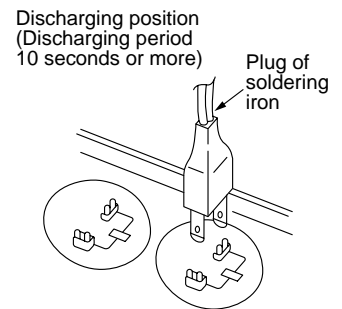

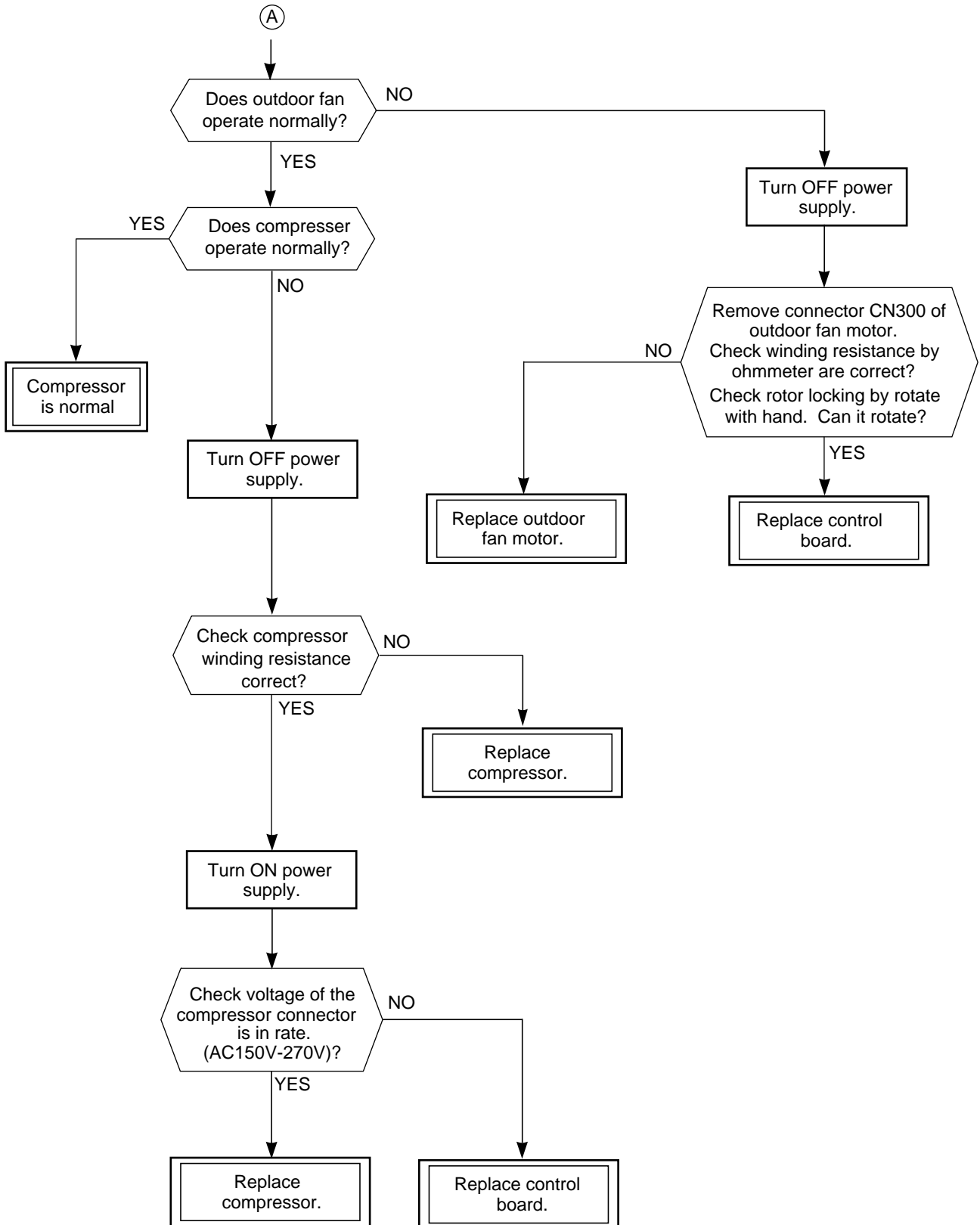

11-8. How to Check Simply the Main Parts

11-8-1. How to check the P.C. board (Indoor unit)

(1) Operating precautions

- 1) When removing the front panel or the P.C. board, be sure to shut off the power supply breaker.
- 2) When removing the P.C. board, hold the edge of the P.C. board and do not apply force to the parts.
- 3) When connecting or disconnecting the connectors on the P.C. board, hold the whole housing. Do not pull at the lead wire.

(2) Inspection procedures

- 1) When a P.C. board is judged to be defective, check for disconnection, burning, or discoloration of the copper foil pattern or this P.C. board.
- 2) The P.C. board consists of the following 2 parts
 - a. **Main P.C. board part:**
DC power supply circuit (5 V, 12 V), Indoor fan motor control circuit, CPU and peripheral circuits, buzzer, and Driving circuit of louver.
 - b. **Indication unit of infrared ray receiving**
Infrared ray receiving circuit, LED:

11-8-2. How to shorten time for start the compressor.

1. Turn on remote.
2. Setting requirement operation.
3. Push off remote.
4. Press [SET] button while pressing [CHECK] button with a tip of a pencil.
5. Then press [ON] button to transmit the signal to the indoor unit.

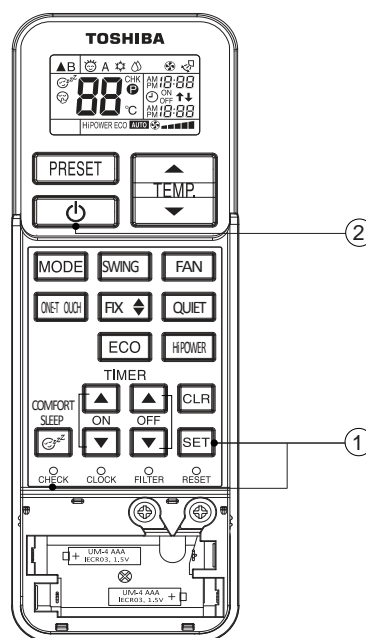

This setting helps to shorten a compressor waiting period when operate cool, heat or dry mode. A compressor suddenly starts one order of Remote controller is received.

11-8-2. P.C. Board Layout

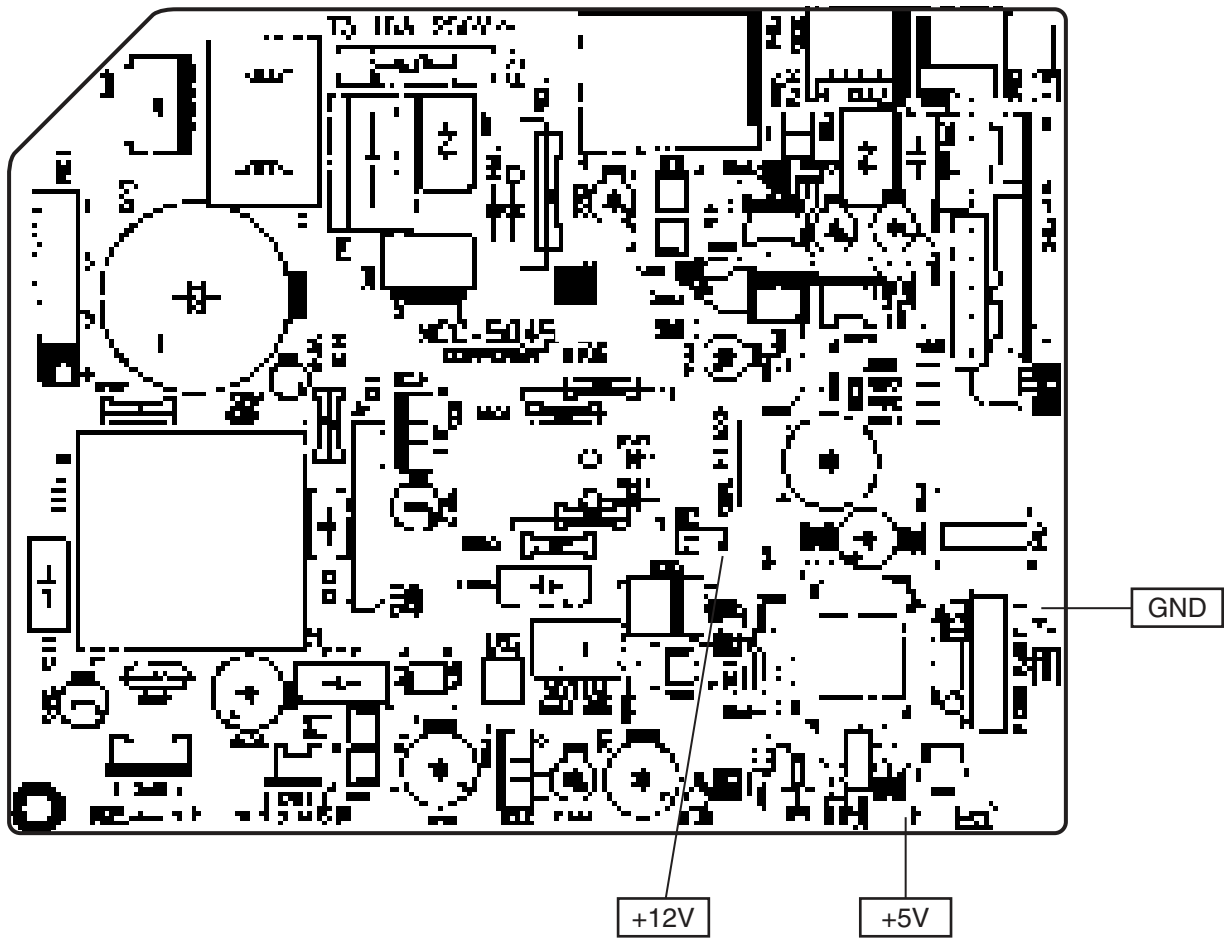

[1] Sensor characteristic table

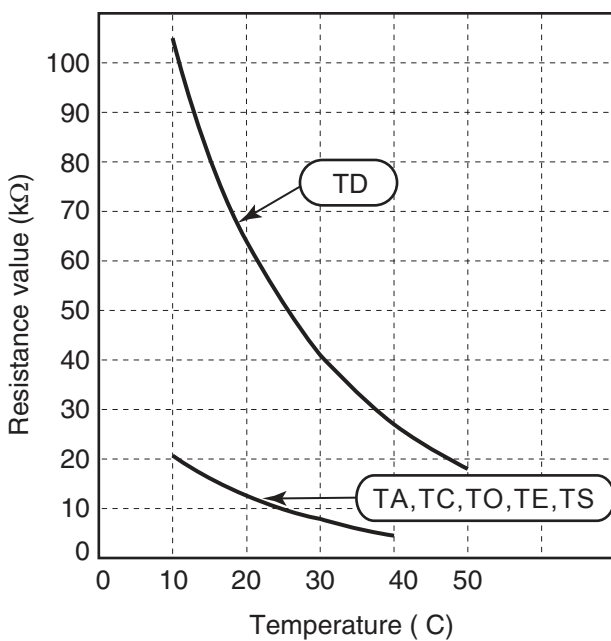

- TD : Discharge temp. sensor
- TA : Room temp. sensor
- TC : Heat exchanger temp. sensor
- TO : Outdoor temp. sensor
- TE : Outdoor heat exchanger temp. sensor
- TS : Suction temp. sensor

11-8-3. Indoor Unit (Other Parts)

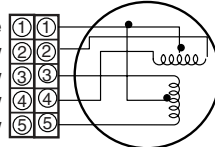
No.	Part name	Checking procedure																		
1	Room temp. (TA) sensor Heat exchanger (TC) sensor	Disconnect the connector and measure the resistance value with tester. (Normal temp.) <table border="1" style="margin-left: 20px;"> <thead> <tr> <th style="text-align: center;">Temperature</th> <th>10°C</th> <th>20°C</th> <th>25°C</th> <th>30°C</th> <th>40°C</th> </tr> </thead> <tbody> <tr> <td style="text-align: center;">Sensor</td> <td></td> <td></td> <td></td> <td></td> <td></td> </tr> <tr> <td style="text-align: center;">TA, TC (kΩ)</td> <td>20.7</td> <td>12.6</td> <td>10.0</td> <td>7.9</td> <td>4.5</td> </tr> </tbody> </table>	Temperature	10°C	20°C	25°C	30°C	40°C	Sensor						TA, TC (kΩ)	20.7	12.6	10.0	7.9	4.5
Temperature	10°C	20°C	25°C	30°C	40°C															
Sensor																				
TA, TC (kΩ)	20.7	12.6	10.0	7.9	4.5															
2	Remote controller	Refer to 11-5-1. (5).																		
3	Louver motor MSBPC20F04	Measure the resistance value of each winding coil by using the tester. (Under normal temp. 25°C) <div style="display: flex; align-items: center; margin-left: 20px;"> <div style="margin-right: 10px;"> White ①① Yellow ②② Yellow ③③ Yellow ④④ Yellow ⑤⑤ </div>  <table border="1" style="margin-left: 20px;"> <thead> <tr> <th>Position</th> <th>Resistance value</th> </tr> </thead> <tbody> <tr> <td>1 to 2</td> <td rowspan="5" style="text-align: center;">250 ± 20Ω</td> </tr> <tr> <td>1 to 3</td> </tr> <tr> <td>1 to 4</td> </tr> <tr> <td>1 to 5</td> </tr> <tr> <td>1 to 5</td> </tr> </tbody> </table> </div>	Position	Resistance value	1 to 2	250 ± 20Ω	1 to 3	1 to 4	1 to 5	1 to 5										
Position	Resistance value																			
1 to 2	250 ± 20Ω																			
1 to 3																				
1 to 4																				
1 to 5																				
1 to 5																				
4	Indoor fan motor	Refer to 11-5-1. (3) and (4).																		

11-8-4. Outdoor Unit

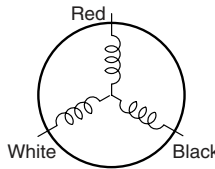
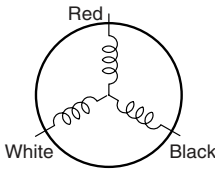
No.	Part name	Checking procedure																												
1	Compressor (Model : DA131S1B-31FZ) (RAS-18N3AV-E) (Model : DA150A1F-20F) (RAS-22N3AV-E)	Measure the resistance value of each winding by using the tester.  <table border="1" style="margin-left: 20px;"> <thead> <tr> <th rowspan="2">Position</th> <th colspan="2">Resistance value</th> </tr> <tr> <th>DA131S1B-31FZ</th> <th>DA150A1F-20F</th> </tr> </thead> <tbody> <tr> <td>Red - White</td> <td rowspan="3" style="text-align: center;">1.70Ω</td> <td rowspan="3" style="text-align: center;">0.93Ω</td> </tr> <tr> <td>White - Black</td> </tr> <tr> <td>Black - Red</td> </tr> </tbody> </table> <p style="text-align: right; margin-right: 20px;">Under 20°C</p>	Position	Resistance value		DA131S1B-31FZ	DA150A1F-20F	Red - White	1.70Ω	0.93Ω	White - Black	Black - Red																		
Position	Resistance value																													
	DA131S1B-31FZ	DA150A1F-20F																												
Red - White	1.70Ω	0.93Ω																												
White - Black																														
Black - Red																														
2	Outdoor fan motor (Model : ICF-140-43-4R)	Measure the resistance value of winding by using the tester.  <table border="1" style="margin-left: 20px;"> <thead> <tr> <th>Position</th> <th>Resistance value</th> </tr> </thead> <tbody> <tr> <td>Red - White</td> <td>20 to 22Ω</td> </tr> <tr> <td>White - Black</td> <td>20 to 22Ω</td> </tr> <tr> <td>Black- Red</td> <td>20 to 22Ω</td> </tr> </tbody> </table> <p style="text-align: right; margin-right: 20px;">Under 20°C</p>	Position	Resistance value	Red - White	20 to 22Ω	White - Black	20 to 22Ω	Black- Red	20 to 22Ω																				
Position	Resistance value																													
Red - White	20 to 22Ω																													
White - Black	20 to 22Ω																													
Black- Red	20 to 22Ω																													
3	4-way valve coil (Model : STF-01AJ646A1) (RAS-18N3AV-E) (Model : STF-01AJ503K1) (RAS-22N3AV-E)	Measure the resistance value of winding by using the tester. <table border="1" style="margin-left: 20px;"> <thead> <tr> <th>Resistance value</th> </tr> </thead> <tbody> <tr> <td style="text-align: center;">1435 ± 144Ω</td> </tr> </tbody> </table> <p style="text-align: right; margin-right: 20px;">Under 20°C</p>	Resistance value	1435 ± 144Ω																										
Resistance value																														
1435 ± 144Ω																														
4	Pulse motor valve coil (Model : CAM-MD12TCTH-5)	Measure the resistance value of winding by using the tester. <table border="1" style="margin-left: 20px;"> <thead> <tr> <th>Position</th> <th>Resistance value</th> </tr> </thead> <tbody> <tr> <td>Red - White</td> <td>42 to 50Ω</td> </tr> <tr> <td>White - Orange</td> <td>42 to 50Ω</td> </tr> <tr> <td>Brown- Yellow</td> <td>42 to 50Ω</td> </tr> <tr> <td>Brown- Blue</td> <td>42 to 50Ω</td> </tr> </tbody> </table> <p style="text-align: right; margin-right: 20px;">Under 20°C</p>	Position	Resistance value	Red - White	42 to 50Ω	White - Orange	42 to 50Ω	Brown- Yellow	42 to 50Ω	Brown- Blue	42 to 50Ω																		
Position	Resistance value																													
Red - White	42 to 50Ω																													
White - Orange	42 to 50Ω																													
Brown- Yellow	42 to 50Ω																													
Brown- Blue	42 to 50Ω																													
5	Outdoor temperature sensor (TO), discharge temperature sensor (TD), suction temperature sensor (TS), outdoor heat exchanger temperature sensor (TE)	Disconnect the connector, and measure resistance value with the tester. (Normal temperature) <table border="1" style="margin-left: 20px;"> <thead> <tr> <th style="text-align: center;">Temperature</th> <th>10°C</th> <th>20°C</th> <th>25°C</th> <th>30°C</th> <th>40°C</th> <th>50°C</th> </tr> </thead> <tbody> <tr> <td style="text-align: center;">Sensor</td> <td></td> <td></td> <td></td> <td></td> <td></td> <td></td> </tr> <tr> <td style="text-align: center;">TD (kΩ)</td> <td>100</td> <td>62</td> <td>50</td> <td>41</td> <td>27</td> <td>18</td> </tr> <tr> <td style="text-align: center;">TO,TS,TE (kΩ)</td> <td>20.7</td> <td>12.6</td> <td>10.0</td> <td>7.9</td> <td>4.5</td> <td>—</td> </tr> </tbody> </table>	Temperature	10°C	20°C	25°C	30°C	40°C	50°C	Sensor							TD (kΩ)	100	62	50	41	27	18	TO,TS,TE (kΩ)	20.7	12.6	10.0	7.9	4.5	—
Temperature	10°C	20°C	25°C	30°C	40°C	50°C																								
Sensor																														
TD (kΩ)	100	62	50	41	27	18																								
TO,TS,TE (kΩ)	20.7	12.6	10.0	7.9	4.5	—																								

11-8-5. Checking Method for Each Part

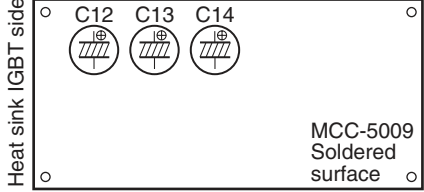
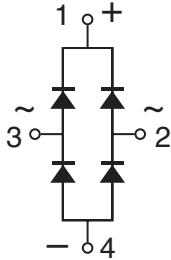
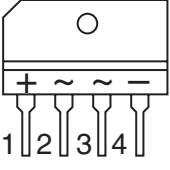
No.	Part name	Checking procedure												
1	Electrolytic capacitor (For boost, smoothing)	<p>1. Turn OFF the power supply breaker. 2. Discharge all three capacitors completely. 3. Check that safety valve at the bottom of capacitor is not broken. 4. Check that vessel is not swollen or exploded. 5. Check that electrolytic liquid does not blow off. 6. Check that the normal charging characteristics are shown in continuity test by the tester.</p> <div style="display: flex; align-items: center;"> <div style="border: 1px solid black; padding: 5px; margin-right: 20px;"> <p style="writing-mode: vertical-rl; transform: rotate(180deg); font-size: small;">Heat sink (GBT side)</p>  </div> <div style="border: 1px solid black; padding: 5px; margin-right: 20px;"> <p style="text-align: center; font-weight: bold; font-size: small;">Case that product is good</p> <p style="font-size: x-small;">Pointer swings once, and returns slowly. When performing test once again under another polarity, the pointer should return.</p> </div> </div> <p style="font-size: small;">C12, C13, C14 → 500μF/400V or 760μF/400V</p>												
2	Diode block	<p>1. Turn OFF the power supply breaker. 2. Completely discharge the four electrolytic capacitors. 3. Remove the diode block from the P.C. board (which is soldered in place). 4. Use a multimeter with a pointer to test the continuity, and check that the diode block has the proper rectification characteristics.</p> <div style="display: flex; align-items: center; justify-content: space-around;"> <div style="text-align: center;">  </div> <div style="text-align: center;">  <p>(DB01)</p> </div> <div style="border: 1px solid black; padding: 5px;"> <table border="1" style="font-size: x-small; border-collapse: collapse;"> <thead> <tr> <th colspan="2" style="text-align: center;">Tester rod</th> <th style="text-align: center;">Resistance value in good product</th> </tr> </thead> <tbody> <tr> <td style="text-align: center;">⊕</td> <td style="text-align: center;">⊖</td> <td rowspan="4" style="text-align: center; vertical-align: middle;">∞</td> </tr> <tr> <td style="text-align: center;">~ 2</td> <td style="text-align: center;">+ 1</td> </tr> <tr> <td style="text-align: center;">~ 3</td> <td style="text-align: center;">~ 2</td> </tr> <tr> <td style="text-align: center;">- 4</td> <td style="text-align: center;">~ 3</td> </tr> </tbody> </table> <p style="font-size: x-small; margin-top: 5px;">10 to 20 Ω when the multimeter probe is reversed</p> </div> </div>	Tester rod		Resistance value in good product	⊕	⊖	∞	~ 2	+ 1	~ 3	~ 2	- 4	~ 3
Tester rod		Resistance value in good product												
⊕	⊖	∞												
~ 2	+ 1													
~ 3	~ 2													
- 4	~ 3													

11-9. How to Simply Judge Whether Outdoor Fan Motor is Good or Bad

1. Symptom

- Outdoor fan motor does not rotate.
 - Outdoor fan motor stops within several 10 seconds though it started rotating.
 - Outdoor fan motor rotates or does not rotate according to the position where the fan stopped, etc.
- Remote controller check code “02 : Outdoor block, 1A : Outdoor fan drive system error”

2. Cause

The following causes are considered when the outdoor fan motor does not normally rotate.

- 1) Mechanical lock of the outdoor fan motor
- 2) Winding failure of the outdoor fan motor
- 3) Position-detect circuit failure inside of the outdoor fan motor
- 4) Motor drive circuit failure of the outdoor P.C. board

3. How to simply judge whether outdoor fan motor is good or bad

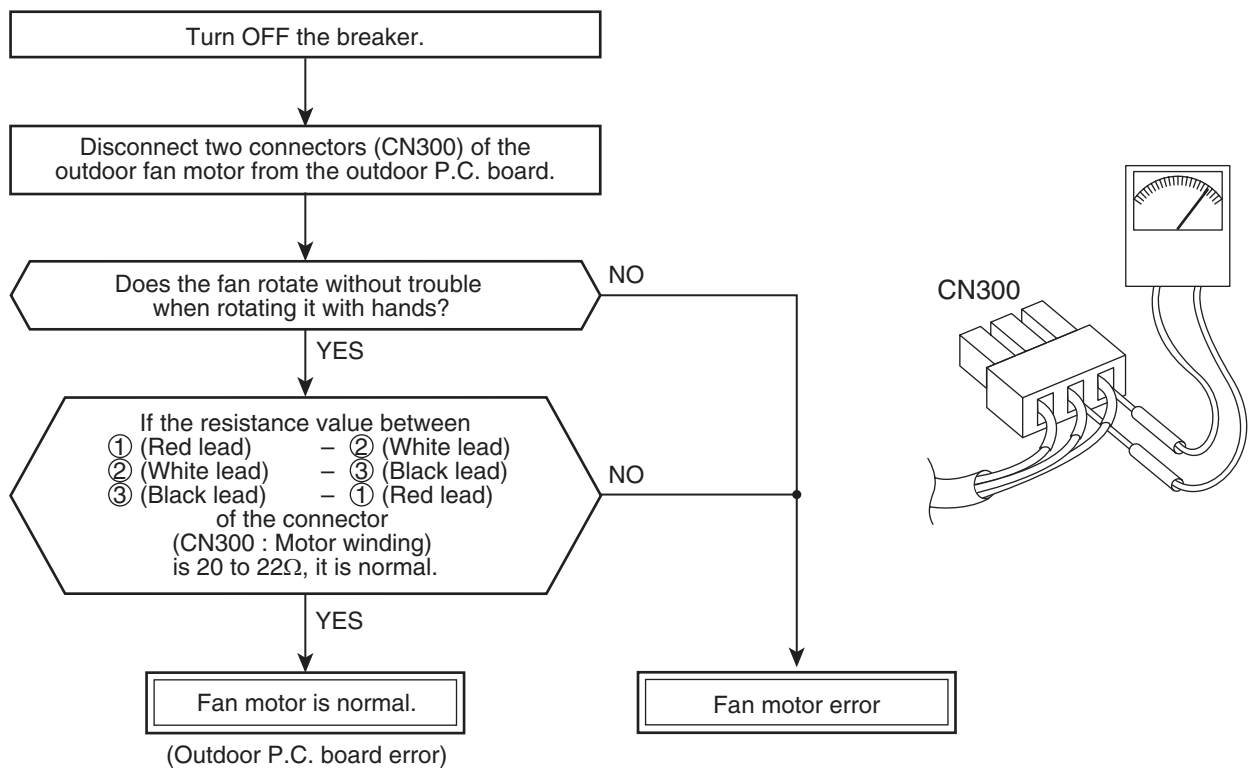

NOTE :



However, GND circuit error inside of the motor may be accepted in some cases when the above check is performed.

When the fan motor does not become normal even if P.C. board is replaced, replace the outdoor fan motor.

12. HOW TO REPLACE THE MAIN PARTS



- Since high voltages pass through the electrical parts, turn off the power without fail before proceeding with the repairs.
Electric shocks may occur if the power plug is not disconnected.
- After the repairs have been completed (after the front panel and cabinet have been installed), perform a test run, and check for smoking, unusual sounds and other abnormalities.
If this check is omitted, a fire and/or electric shocks may occur.
Before proceeding with the test run, install the front panel and cabinet.
- Ensure that the following steps are taken when doing repairs on the refrigerating cycle.
 1. Do not allow any naked flames in the surrounding area.
If a gas stove or other appliance is being used, extinguish the flames before proceeding.
If the flames are not extinguished, they may ignite any oil mixed with the refrigerant gas.
 2. Do not use welding equipment in an airtight room.
Carbon monoxide poisoning may result if the room is not properly ventilated.
 3. Do not bring welding equipment near flammable objects.
Flames from the equipment may cause the flammable objects to catch fire.
- **If keeping the power on is absolutely unavoidable while doing a job such as inspecting the circuitry, wear rubber gloves to avoid contact with the live parts.**
Electric shocks may be received if the live parts are touched.
High-voltage circuits are contained inside this unit.
Proceed very carefully when conducting checks since directly touching the parts on the control circuit board may result in electric shocks.

12-1. Indoor Unit

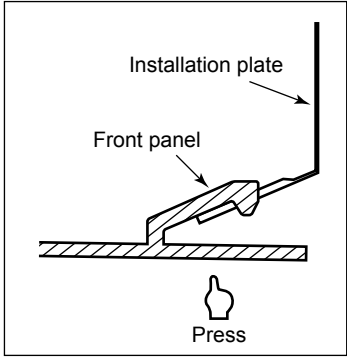
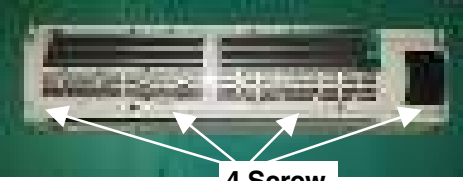
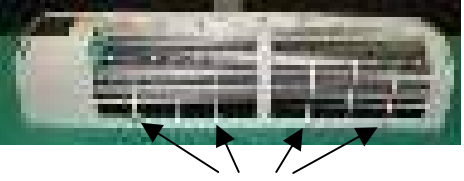
No.	Part name	Procedures	Remarks
①	Front panel	1) Stop operation of the air conditioner and turn off its main power supply. 2) Open the air inlet grille, push the arm toward the outside, and remove the grille. 3) Remove the left and right air filters.	 

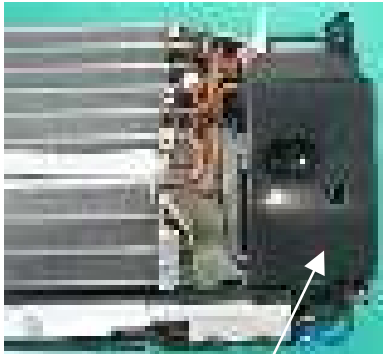
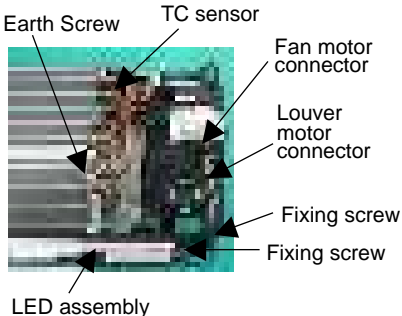
No.	Part name	Procedures	Remarks
①	Front panel	<p>4) Press "PUSH" part under the front panel and remove hooks of the front panel from the installation plate.</p> <p>5) Remove the front panel fixing screws. (4 pcs.)</p> <p>6) Take off four hooks of panel from rear side.</p> 	  
<p><How to assemble the front panel></p> <p>1) Press three center positions and two lower center positions of the air outlet, and then hang the hanging hooks (4 pcs.) at the top side of the front panel to the rear plate.</p> <p>2) Tighten four screws.</p> <ul style="list-style-type: none"> • Incomplete hanging or incomplete pressing may cause a dewdrops or generation of a fluttering sound. 			

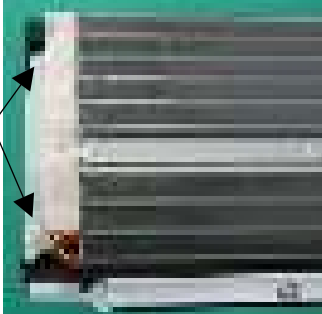
No.	Part name	Procedures	Remarks
②	Electric parts box assembly	<p>1) Follow the procedure up to 6) in ① above.</p> <p>2) Remove screw of earth lead attached to the end plate of the evaporator.</p> <p>3) Remove the lead wire cover, and remove connector for the fan motor and connector for the louver motor from the electric parts box assembly.</p> <p>4) Pull out TC sensor from sensor holder of the evaporator.</p> <p>5) Disengage the display unit by simply pushing at the top of the display unit.</p> <p>6) Remove the fixing screw that secures the electric parts box assembly, LED assembly and remove the assembly.</p> <p><How to assemble the electric parts box></p> <p>1) Hook the top part of the electric parts box assembly onto the claws on the back body, and secure it using the fixing screw. Now attach the display unit. Connect the connectors for the fan motor and louver motor.</p> <p>2) Secure the grounding wire using the fixing screw. Insert the TC sensor into the sensor holder.</p> <p>* Be absolutely sure to loop the grounding wire and TC sensor leads once at the bottom.</p>	 <p>Electric part box cover</p>  <p>Earth Screw TC sensor Fan motor connector Louver motor connector Fixing screw Fixing screw LED assembly</p>

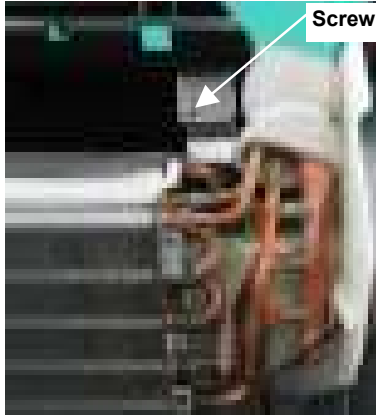
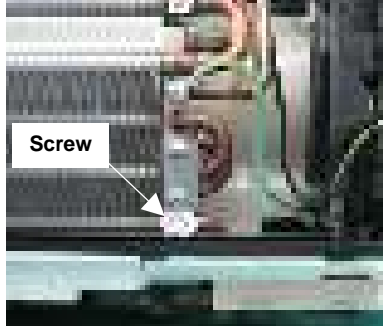
No.	Part name	Procedures	Remarks
③	Horizontal louver	1) Remove shaft of the horizontal louver from the back body. (First remove the left shaft, and then remove other shafts while sliding the horizontal louver leftward.)	
④	Evaporator (Heat exchanger)	1) Follow to the procedure in the item ② . 2) Remove the pipe holder from the rear side of the main unit. 3) Remove two fixing screws at the left side of the end plate of the heat exchanger.  2 Screws 4) Remove two fixing screw on the heat exchange fixing holder to separate the heat exchange from the back body.	  Screw  Screw

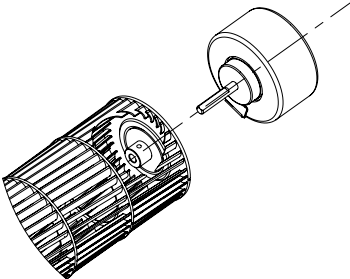
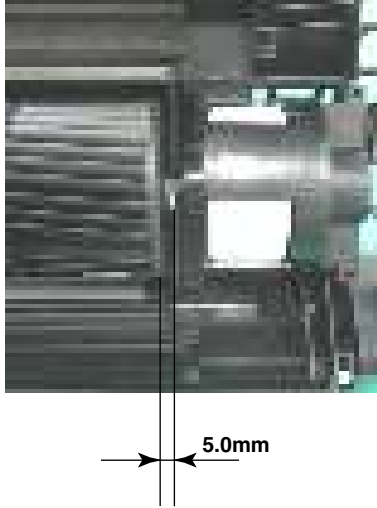

No.	Part name	Procedures	Remarks
⑤	Bearing	<p>1) Follow to the procedure in the item ④ .</p> <p>2) Remove the two screws used to secure the bearing base.</p> <p>3) Remove the bearing base.</p> <p><Caution at assembling></p> <ul style="list-style-type: none"> • If the bearing is out from the housing, push it into the specified position and then incorporate it in the main body. 	 <p>The top photograph shows a close-up of the bearing base with two screws being removed. An arrow points to the screws with the label 'Two screws'.</p> <p>The bottom photograph shows the bearing base and the bearing. An arrow points to the bearing base with the label 'Bearing base', and another arrow points to the bearing with the label 'Bearing'.</p>

No.	Part name	Procedures	Remarks
⑦	Cross flow fan	<p><Caution at reassembling></p> <p>1) To incorporate the fan motor, remove the fan motor rubber (at shaft core side), incorporate the motor into the position in the following figure, and then install the fan motor.</p> <ul style="list-style-type: none"> • Install the cross flow fan so that the right end of the 1st joint from the right of the cross flow fan is set keeping 5 mm from wall of rear plate of the main unit. • Holding the set screw, install the cross flow fan so that U-groove of the fan motor comes to the mounting hole of the set screw.  <ul style="list-style-type: none"> • Perform positioning of the fan motor as follows: • When assembling the fan motor, the fan motor must be installed in such a way that the fan motor leads will be taken out is positioned at the bottom front. • After assembling the two fixing screw of the motor band (right) into the main body, position the fan motor, insert it, and then secure the motor band (right) using the two fixing screws. 	

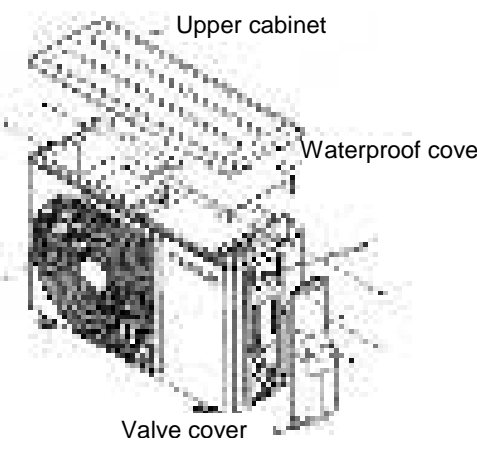
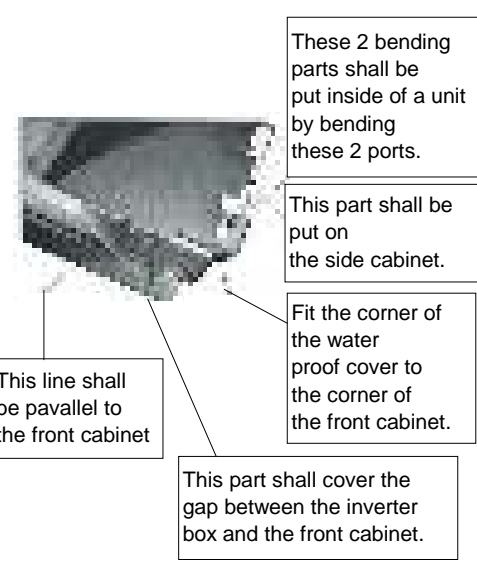
12-3. Outdoor Unit

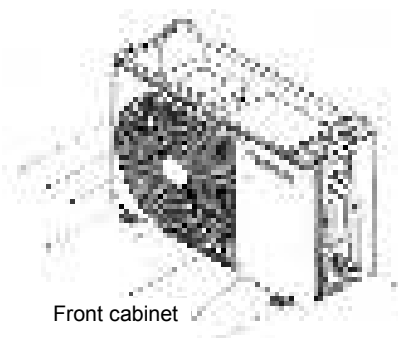
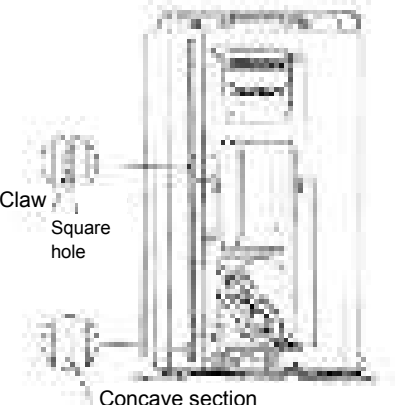
No.	Part name	Procedure	Remarks
①	Common procedure	<p>1. Detachment</p> <div style="border: 1px solid black; padding: 5px; margin-bottom: 10px;"> <p>Wear gloves for this job. Otherwise, you may injure your hands on the parts, etc.</p> </div> <ol style="list-style-type: none"> 1) Stop operation of the air conditioner, and turn off the main switch of the breaker for air conditioner. 2) Remove the valve cover. (ST1TØ4 × 10L 2 pcs.) <ul style="list-style-type: none"> • After removing screw, remove the valve cover pulling it downward. 3) Remove cord clamp (ST2TØ4 × 14L 3 pcs.), and then remove connecting cable. 4) Remove the upper cabinet. (ST1TØ4 × 10L 5 pcs.) <ul style="list-style-type: none"> • After removing screws, remove the upper cabinet pulling it upward. <p>2. Attachment</p> <ol style="list-style-type: none"> 1) Attach the water-proof cover. <div style="border: 1px solid black; padding: 5px; margin-bottom: 10px;"> <p>The water-proof cover must be attached without fail in order to prevent rain water, etc. from entering inside the indoor unit.</p> </div> <ol style="list-style-type: none"> 2) Attach the upper cabinet. (ST1TØ4 × 10L 5 pcs.) 3) Perform cabling of connecting cable, and attach the cord clamp. <ul style="list-style-type: none"> • Fix the cord clamp by tightening the screws (ST2TØ 4 x 14L 3 pcs.), fitting 2 concave parts of the cord clamp to each connecting cables. 4) Attach the valve cover. (ST1TØ 4 x 10L 2 pcs.) <ul style="list-style-type: none"> • Insert the upper part into the square hole of the side cabinet, set hook claws of the valve cover to square holes (at three positions) of the main unit, and attach it pushing upward, 	 <p>Upper cabinet Waterproof cover Valve cover</p>  <p>These 2 bending parts shall be put inside of a unit by bending these 2 ports. This part shall be put on the side cabinet. Fit the corner of the water proof cover to the corner of the front cabinet. This part shall cover the gap between the inverter box and the front cabinet. This line shall be pavallel to the front cabinet</p> <div style="border: 1px solid black; padding: 5px; margin-top: 10px;"> <p>How to mount the water-proof cover</p> </div>

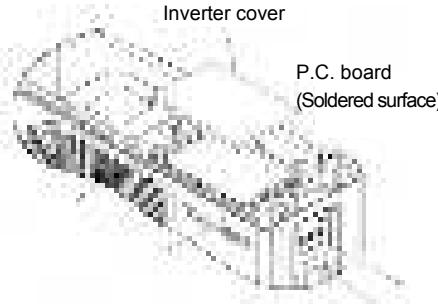
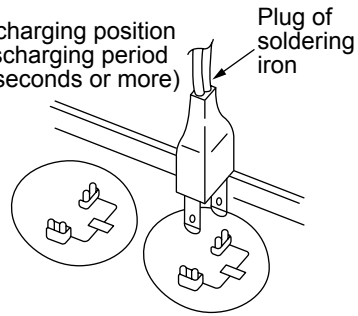
No.	Part name	Procedure	Remarks
②	Front cabinet	<p>1. Detachment</p> <ol style="list-style-type: none"> 1) Perform step 1 in ①. 2) Remove the fixing screws (ST1TØ4 × 10L 2 pcs.) used to secure the front cabinet and inverter cover, the screws (ST1TØ4 × 10L 4 pcs.) used to secure the front cabinet at the bottom, and the fixing screws (ST1TØ4 × 10L 2 pcs.) used to secure the motor base. <ul style="list-style-type: none"> • The front cabinet is fitted into the side cabinet (left) at the front left side so pull up the top of the front cabinet to remove it. <p>2. Attachment</p> <ol style="list-style-type: none"> 1) Insert the claw on the front left side into the side cabinet (left). 2) Hook the bottom part of the front right side onto the concave section of the bottom plate. Insert the claw of the side cabinet (right) into the square hole in the front cabinet. 3) Return the screws that were removed above to their original positions and attach them. 	 <p>Front cabinet</p>  <p>Claw Square hole Concave section</p>

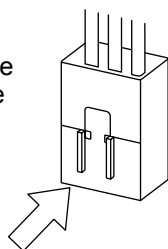
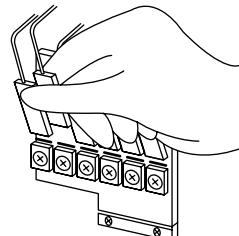
No.	Part name	Procedure	Remarks
③	Inverter assembly	<p>1) Perform work of item 1 in ①.</p> <p>2) Remove screw (ST1TØ4 × 10L 2 pcs.) of the upper part of the front cabinet.</p> <ul style="list-style-type: none"> • If removing the inverter cover in this condition, P.C. board can be checked. • If there is no space above the unit, perform work of 1 in ②. <div style="border: 1px solid black; padding: 5px; margin: 10px 0;"> <p>Be careful to check the inverter because high-voltage circuit is incorporated in it.</p> </div> <p>3) Perform discharging by connecting ⊕, ⊖ polarity by discharging resistance (approx. 100Ω40W) or plug of soldering iron to ⊕, ⊖ terminals a of the C14 (printed "CAUTION HIGH VOLTAGE" is attached.) electrolytic capacitor (760μF or 500μF) on P.C. board.</p> <div style="border: 1px solid black; padding: 5px; margin: 10px 0;"> <p>Be careful to discharge the capacitor because the electrolytic capacitor cannot naturally discharge and voltage remains according to trouble type in some cases.</p> </div> <div style="border: 1px solid black; padding: 5px; margin: 10px 0;"> <p>This capacitor is one with mass capacity. Therefore, it is dangerous that a large spark generates if short-circuiting between ⊕, ⊖</p> </div> <p>4) Remove screw (ST1TØ4 x 10L 4pcs.) fixing the terminal part of inverter box to the main body.</p> <p>5) Remove the front cabinet by performing step 1 in ② , and remove the fixing screws (ST1TØ4 x 10L) for securing the main body and inverter box.</p> <p>6) Remove various lead wires from the holder at upper part of the inverter box.</p> <p>7) Pull the inverter box upward.</p> <p>8) Disconnect connectors of various lead wires.</p> <div style="border: 1px solid black; padding: 5px; margin: 10px 0;"> <p>As each connector has a lock mechanism, avoid to remove the connector by holding the lead wire, but by holding the connector.</p> </div>	<p style="text-align: center;">Inverter cover</p>  <p style="text-align: right;">P.C. board (Soldered surface)</p> <p>Discharging position (Discharging period 10 seconds or more)</p> <p>Plug of soldering iron</p>   <p>The connector is one with lock, so remove it while pushing the part indicated by an arrow.</p>   <p>Be sure to remove the connector by holding the connector, not by pulling the lead wire.</p>

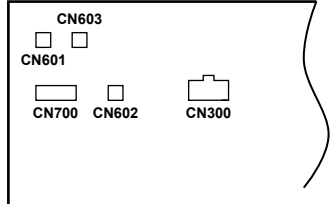
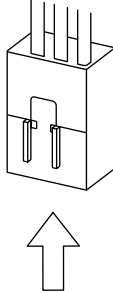
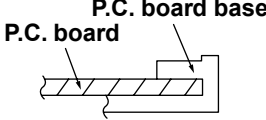
No.	Part name	Procedure	Remarks
④	Control board assembly	<p>1. Disconnect the leads and connectors connected to the other parts from the control board assembly.</p> <p>1) Leads</p> <ul style="list-style-type: none"> • 3 leads (black, white, orange) connected to terminal block. • Lead connected to compressor : Disconnect the connector (3P). • Lead connected to reactor : Disconnect the two connectors (2P). <p>2) Connectors (×8)</p> <p>CN300 : Outdoor fan motor (3P: white)* (* : See Note)</p> <p>CN700 : PMV (6P: white)</p> <p>CN603 : TS sensor (3P: white)*</p> <p>CN601 : TD sensor (3P: white)*</p> <p>CN602 : TO sensor (2P: white)</p> <div style="border: 1px solid black; padding: 5px; margin: 10px 0;"> <p>These connectors have a disconnect prevention mechanism: as such, the lock on their housing must be released before they are disconnected.</p> </div> <p>2. Remove the control board assembly from the P.C. board base. (Remove the heat sink and control board assembly while keeping them screwed together.)</p> <div style="border: 1px solid black; padding: 5px; margin: 10px 0;"> <p>Disengage the four claws of the P.C. board base, hold the heat sink, and lift to remove it.</p> </div> <p>3. Remove the two fixing screws used to secure the heat sink and control board assembly.</p> <p>4. Mount the new control board assembly.</p> <div style="border: 1px solid black; padding: 5px; margin: 10px 0;"> <p>When mounting the new control board assembly, ensure that the P.C. board is inserted properly into the P.C. board support groove.</p> </div>	 <p>CN300 and CN603 are connectors with locking mechanisms: as such, to disconnect them, they must be pressed in the direction of the arrow while pulling them out.</p>  

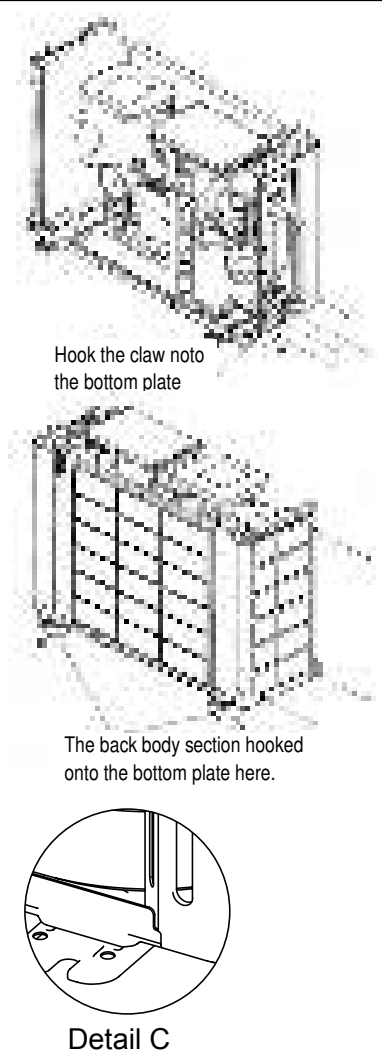
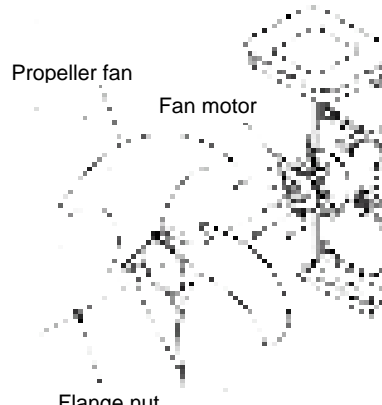
No.	Part name	Procedure	Remarks
⑤	Side cabinet	<p>1. Side cabinet (right)</p> <ol style="list-style-type: none"> 1) Perform step 1 in ② and all the steps in ③. 2) Remove the fixing screw (ST1TØ4 × 10L 4 pcs.) used for securing the side cabinet to the bottom plate and valve fixing panel. <p>2. Side cabinet (left)</p> <ol style="list-style-type: none"> 1) Perform step 1 in ②. 2) Remove the fixing screw (ST1TØ4 × 10L 1 pc.) used to secure the side cabinet (left) onto the heat exchanger. 3) Remove the fixing screw (ST1TØ4 × 10L 2 pcs.) used for securing the side cabinet to the bottom plate and heat exchanger. 	 <p>Hook the claw onto the bottom plate</p> <p>The back body section hooked onto the bottom plate here.</p> <p>Detail A Detail B Detail C</p>
⑥	Fan motor	<ol style="list-style-type: none"> 1) Perform work of item 1 of ① and ②. 2) Remove the flange nut fixing the fan motor and the propeller. <ul style="list-style-type: none"> • Flange nut is loosened by turning clockwise. (To tighten the flange nut, turn counterclockwise.) 3) Remove the propeller fan. 4) Disconnect the connector for fan motor from the inverter. 5) Remove the fixing screws (4 pcs.) holding by hands so that the fan motor does not fall. <p>* Precautions when assembling the fan motor Tighten the flange nut using a tightening torque of 4.9 N•m.</p>	 <p>Propeller fan Fan motor</p> <p>Flange nut</p>

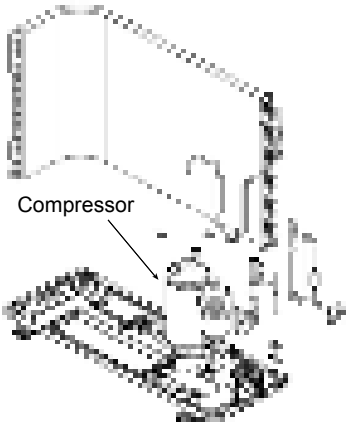
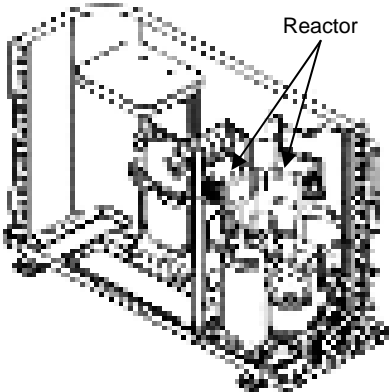
No.	Part name	Procedure	Remarks
⑦	Compressor	<ol style="list-style-type: none"> 1) Perform work of item 1 of ① and ②, ③, ④, ⑤. 2) Extract refrigerant gas. 3) Remove the partition board. (ST1TØ4 × 10L 3 pcs.) 4) Remove the sound-insulation material. 5) Remove terminal cover of the compressor, and disconnect lead wire of the compressor from the terminal. 6) Remove pipe connected to the compressor with a burner. 7) Remove the fixing screw of the bottom plate and heat exchanger. (ST1TØ4 × 10L 1 pc.) 8) Remove the fixing screw of the bottom plate and valve fixing plate. (ST1TØ4 × 10L 1 pc.) 9) Pull upward the refrigeration cycle. 10) Remove NUT (3 pcs.) fixing the compressor to the bottom plate. 	
⑧	Reactor	<ol style="list-style-type: none"> 1) Perform work of item 1 of ②, and ③. 2) Remove screws fixing the reactors. 	

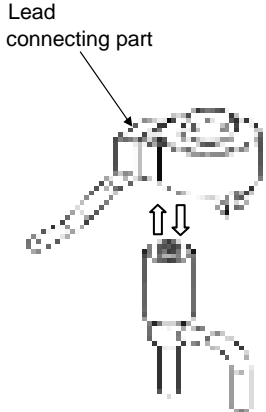
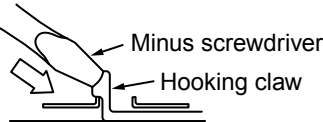
No.	Part name	Procedure	Remarks
⑨	Electronic expansion valve coil	<p>1. Detachment</p> <ol style="list-style-type: none"> 1) Perform step 1 in ②, all the steps in ③ and 1 in ⑤. 2) Remove the coil by rotating it at 90° toward either direction. <p>2. Attachment</p> <ol style="list-style-type: none"> 1) Insert a valve coil in a valve body to the bottom, and fix it by rotating at 90° toward either direction. And confirm to fix it surely. 	
⑩	Fan guard	<p>1. Detachment</p> <ol style="list-style-type: none"> 1) Perform work of item 1 of ②. 2) Remove the front cabinet, and put it down so that fan guard side directs downward. <div style="border: 1px solid black; padding: 5px; margin: 10px 0;"> <p>Perform work on a corrugated cardboard, cloth, etc. to prevent flaw to the product.</p> </div> <ol style="list-style-type: none"> 3) Remove the hooking claws by pushing minus screwdriver according to the arrow mark in the right figure, and remove the fan guard. <p>2. Attachment</p> <ol style="list-style-type: none"> 1) Insert claws of the fan guard in the holes of the front cabinet. Push the hooking claws (9 positions) by hands and fix the claws. <div style="border: 1px solid black; padding: 5px; margin: 10px 0;"> <p>Check that all the hooking claws are fixed to the specified positions.</p> </div>	

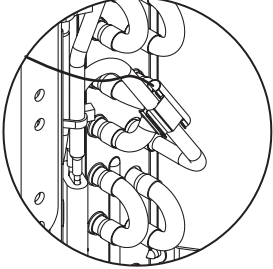
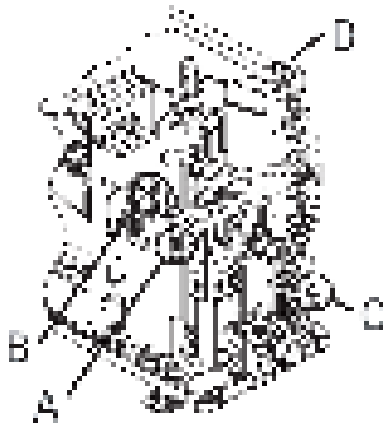
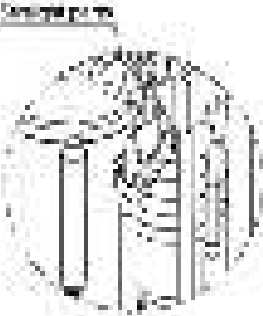
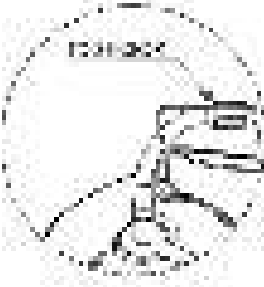
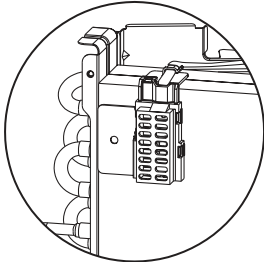
No.	Part name	Procedure	Remarks
⑪	TE sensor (Outdoor heat exchanging temperature sensor) • Attachment With the leads pointing downward and the sensor leads pointing in the direction shown in the figure, install the sensor onto the straight pipe part of the condenser output pipe.	 <p style="text-align: center;">Detail C</p>	
⑫	TS sensor (Suction pipe temperature sensor) • Attachment With its leads pointing downward, point the sensor in the direction of the packed valve, and install it onto the straight pipe part of the suction pipe.		
⑬	TD sensor (Discharge pipe temperature sensor) • Attachment With its leads pointed downward, install the sensor onto the vertical straight pipe part of the discharge pipe.		
⑭	TO sensor (Outside air temperature sensor) • Attachment Insert the outdoor air temperature sensor into the holder and install the holder onto the heat exchanger.	 <p style="text-align: center;">Detail A TS sensor</p>  <p style="text-align: center;">Detail B TD sensor</p>  <p style="text-align: center;">Arrow D TO sensor</p>	
<p>During the installation work (and on its completion), take care not to damage the coverings of the sensor leads on the edges of the metal plates or other parts. It is dangerous for these coverings to be damaged since damage may cause electric shocks and/or a fire.</p>			
<p>After replacing the parts, check whether the positions where the sensors were installed are the proper positions as instructed. The product will not be controlled properly and trouble will result if the sensors have not been installed in their proper positions.</p>			

No.	Part name	Procedure	Remarks																												
⑭	<p>Replacement of temperature sensor for servicing only</p> <p>Common service parts of sensor TO, TS</p> <p>These are parts for servicing sensors. Please check that the accessories shown in the right table are packed.</p>	<ol style="list-style-type: none"> 1) Cut the sensor 100 mm longer than old one. 2) Cut the protective tube after pulling out it (200 mm). 3) Move the protective tube toward the thermal sensor side and tear the tip of lead wire in two then strip the covering part. 4) Pass the stripped part through the thermal constringent tube. 5) Cut the old sensor 100 mm length on the connector side, and recycle that connector. 6) Tear the lead wire in two on the connector side and strip the covering part. 7) Twist the leads on the connector and sensor sides, and solder them. 8) Move the thermal constringent tubes toward the soldered parts and heat them with the dryer and constring them. 9) Wind the attached color tape round the both terminals of the protective tube when colored protective tube is used. 10) Fix the sensor again. <div style="border: 1px solid black; padding: 5px; margin: 10px 0;"> <ol style="list-style-type: none"> 1) Store the joint part of the sensor and the connector in the electric parts box. 2) Never joint them near the thermal sensor part. Otherwise it would cause insulation inferiority because of dew drops. 3) When replacing the sensor using the colored protective tube, wind the color tape matching the color of that tube. </div> <table border="1" style="width: 100%; border-collapse: collapse; margin-top: 10px;"> <thead> <tr> <th style="width: 5%;">Q'ty</th> <th style="width: 65%;">Parts name</th> <th style="width: 10%;">Q'ty</th> <th style="width: 20%;">Remarks</th> </tr> </thead> <tbody> <tr> <td style="text-align: center;">1</td> <td>Sensor</td> <td style="text-align: center;">1</td> <td>Length : 3m</td> </tr> <tr> <td style="text-align: center;">2</td> <td>Sensor Spring (A)</td> <td style="text-align: center;">1</td> <td>For spare</td> </tr> <tr> <td style="text-align: center;">3</td> <td>Sensor Spring (B)</td> <td style="text-align: center;">1</td> <td>For spare</td> </tr> <tr> <td style="text-align: center;">4</td> <td>Thermal constringent tube</td> <td style="text-align: center;">3</td> <td>Including one spare</td> </tr> <tr> <td style="text-align: center;">5</td> <td>Color tape</td> <td style="text-align: center;">1</td> <td>9 colors</td> </tr> <tr> <td style="text-align: center;">6</td> <td>Terminal</td> <td style="text-align: center;">3</td> <td></td> </tr> </tbody> </table>	Q'ty	Parts name	Q'ty	Remarks	1	Sensor	1	Length : 3m	2	Sensor Spring (A)	1	For spare	3	Sensor Spring (B)	1	For spare	4	Thermal constringent tube	3	Including one spare	5	Color tape	1	9 colors	6	Terminal	3		
Q'ty	Parts name	Q'ty	Remarks																												
1	Sensor	1	Length : 3m																												
2	Sensor Spring (A)	1	For spare																												
3	Sensor Spring (B)	1	For spare																												
4	Thermal constringent tube	3	Including one spare																												
5	Color tape	1	9 colors																												
6	Terminal	3																													

13. EXPLODED VIEWS AND PARTS LIST

13-1. Indoor Unit (Part-E)

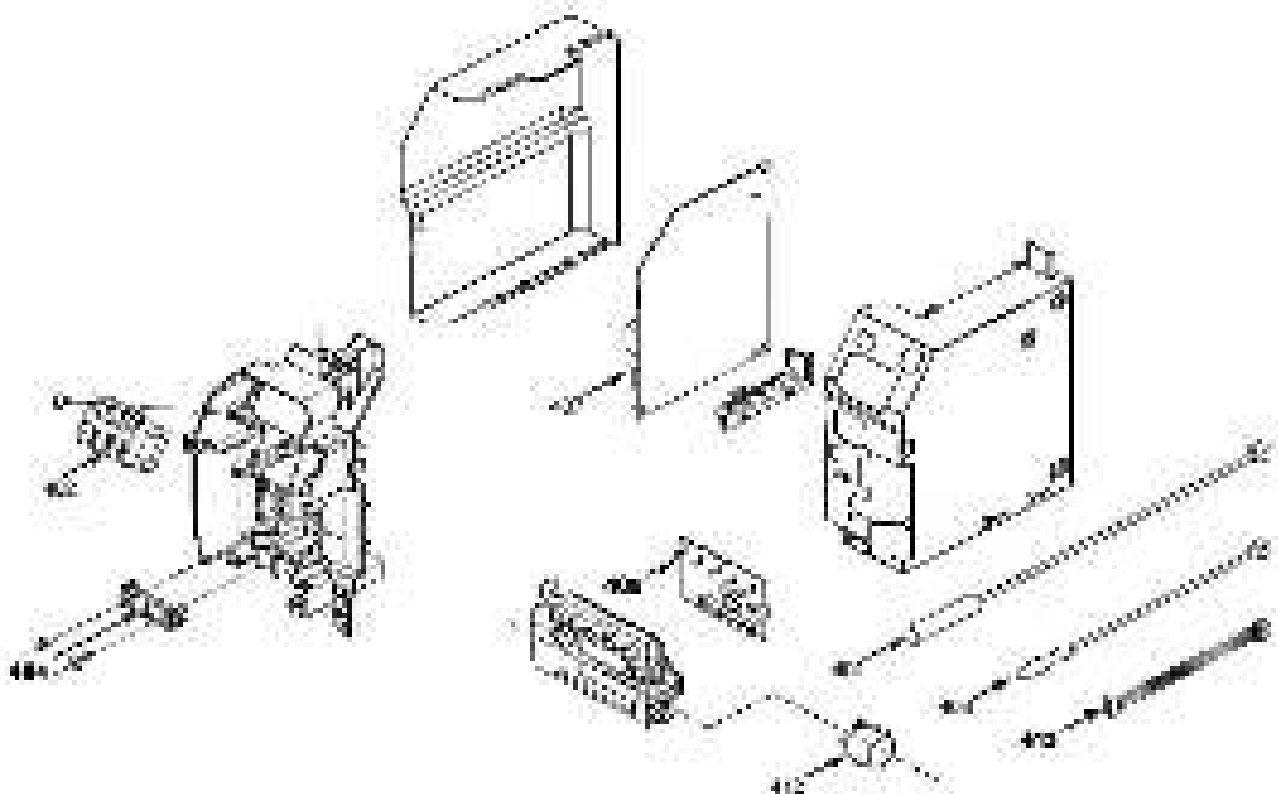

Location No.	Part No.	Description	Location No.	Part No.	Description
401	43T50308	SENSOR HEAT EXCHANGER	407	43T69721	PC BOARD ASSY (For RAS-18N3KV-E)
402	43T60331	TERMINAL; 3P	407	43T69722	PC BOARD ASSY (For RAS-22N3KV-E)
403	43T69320	TEMPERATURE SENSOR	412	43T21434	STEPPING-MOTOR
404	43T62003	CORD CLAMP	413	43T60386	MOTOR CORD
405	43T6V316	PC BOARD ASSY;WRS-LED			

13-2. Indoor Unit

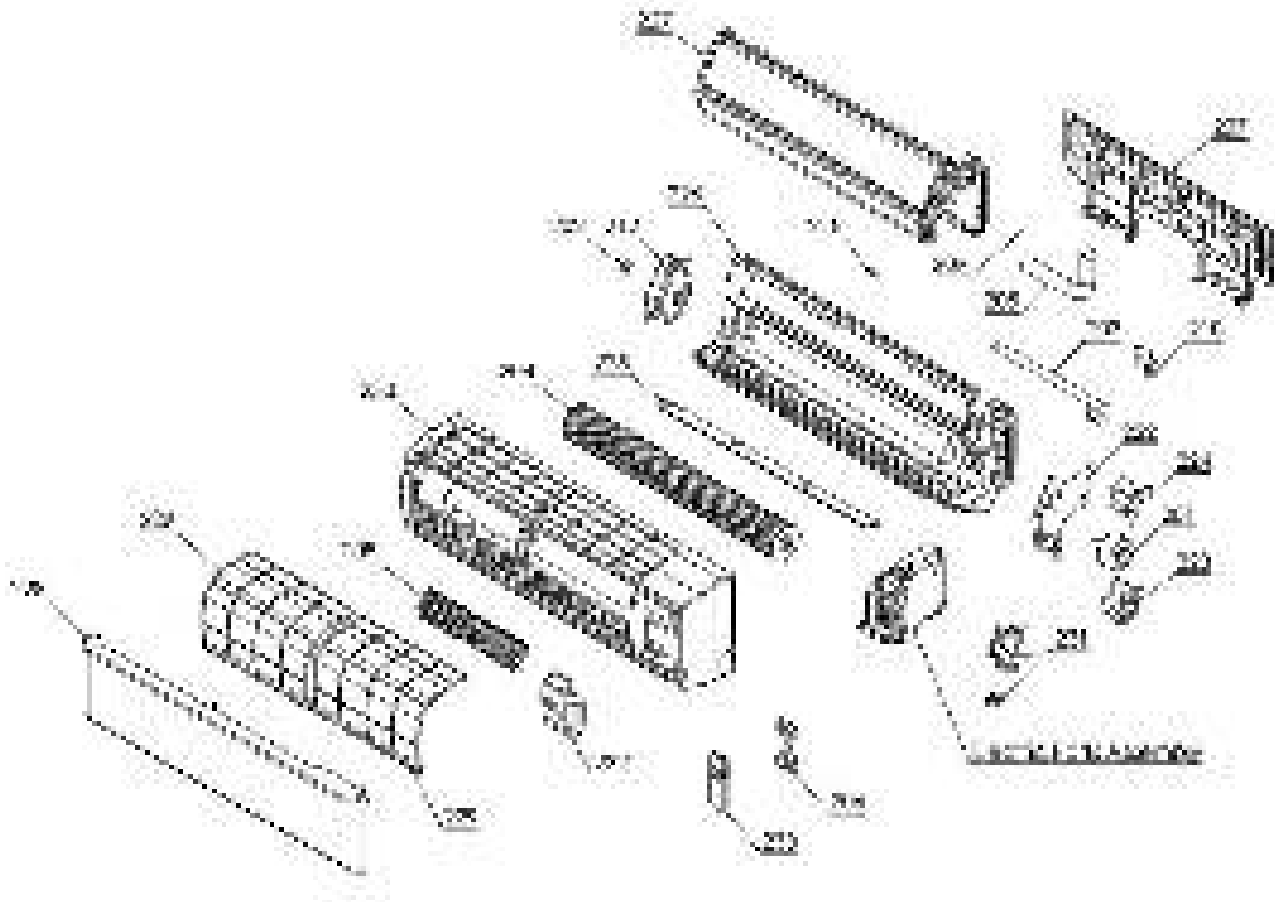

Location No.	Part No.	Description	Location No.	Part No.	Description
201	43T21428	FAN-MOTOR	224	43T39022	BAND, MOTOR, RIGHT UP
202	43T22312	BEARING ASSY, MOLD	225	43T09040	LOUVER, HORIZONTAL
203	43T70313	HOSE, DRAIN	226	43T03014	BODY ASSY, BACK
204	43T20016	FAN, ASSY, CROSS FLOW	227	43T44030	EVAPORATOR ASSY
205	43T49010	PIPE, SHIELD			(For RAS-18N3KV-E)
206	43T83305	HOLDER, REMOTE CONTROL	227	43T44031	EVAPORATOR ASSY
207	43T82008	PLATE, INSTALLATION			(For RAS-22N3KV-E)
209	43T19333	HOLDER, SENSOR	228	43T09471	GRILLE OF AIR INLET ASSY
210	43T49043	HOLDER, PIPE	229	43T80331	FILTER-AIR
212	43T39021	BASE, BEARING	230	43T00586	FRONT PANEL ASSY
218	43T79313	CAP, DRAIN	232	43T62031	COVER, TERMINAL
222	43T39020	BAND, MOTOR, LEFT	233	43T66315	WIRELESS REMOTE CONTROLLER
223	43T39023	BAND,MOTOR, RIGHT DOWN			

13-3. Outdoor Unit

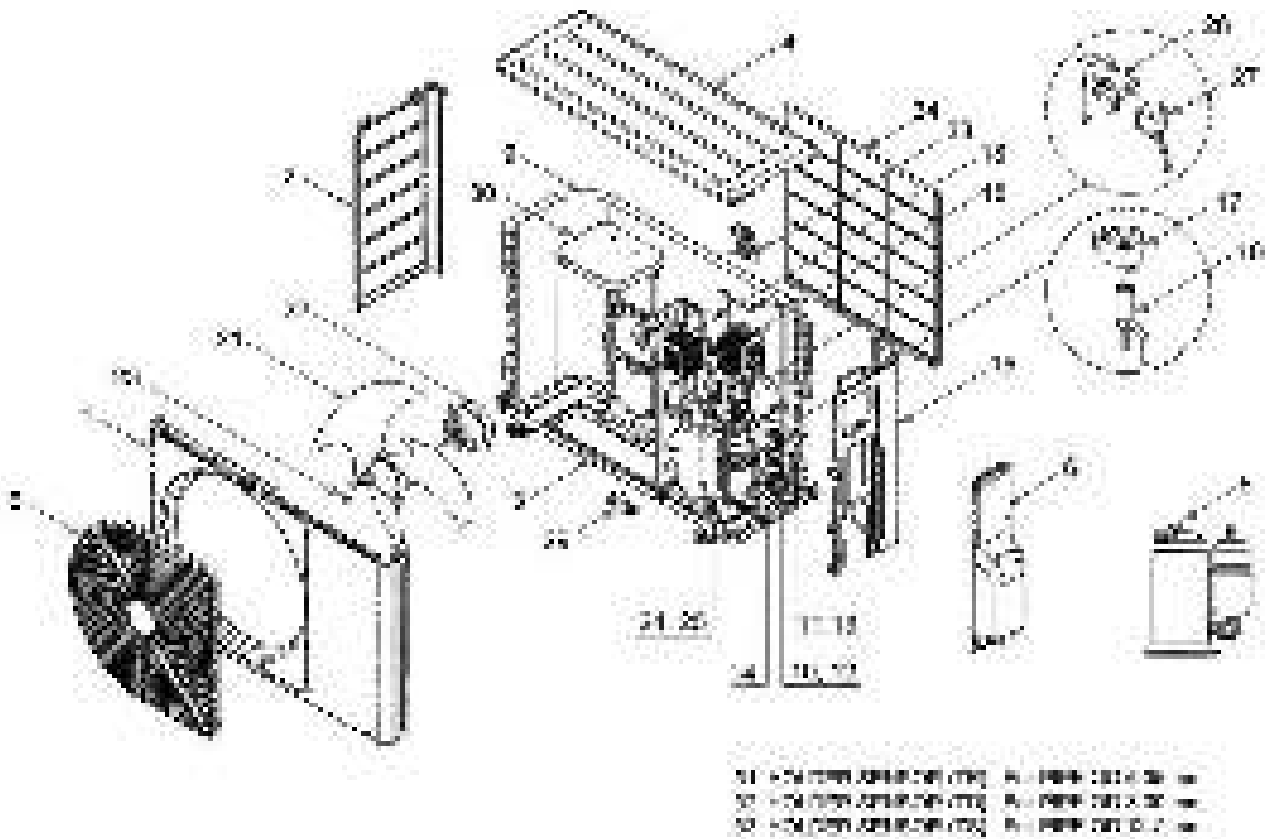

Location No.	Part No.	Description	Location No.	Part No.	Description
1	43T00468	FRONT CABINET	16	43T46347	BODY PMV
2	43T00459	LEFT CABINET	17	43T63329	COIL PMV
3	43T42327	BASE PLATE ASSEMBLY	18	43T58306	REACTOR
4	43T00452	UPPER CABINET	21	43T20319	PROPELLER FAN
5	43T19329	FAN GUARD	22	43T21375	FAN MOTOR
6	43T19348	PACKED VALVE COVER	23	43T47001	NUT FLANGE
8	43T41446	COMPRESSOR (For RAS-18N3AV-E)	24	43T97001	NUT
8	43041627	COMPRESSOR, ASSY (For RAS-22N3AV-E)	25	43T49335	RUBBER CUSHION
9	43T43451	CONDENSER ASSEMBLY (For RAS-18N3AV-E)	26	43T46343	4 WAY VALVE (For RAS-18N3AV-E)
9	43T43452	CONDENSER ASSEMBLY (For RAS-22N3AV-E)	27	43T63320	4 WAY VALVE COIL ASSEMBLY ASSEMBLY (For RAS-18N3AV-E)
10	43T46358	VALVE;PACKED 6.35 DIA	28	43T63319	HOLDER,SENSOR
11	43T46355	VALVE;PACKED 12.7 DIA (H4)	29	43T79305	DRAIN NIPPLE
12	43T47331	BONNET, 6.35 DIA	30	43T39333	MOTOR BASE CONNECTION PLATE
13	43T47333	BONNET, 12.70 DIA	31	43T63318	HOLDER SENSOR
14	43T00448	FIXING PLATE VALVE	32	43T63317	HOLDER,SENSOR
15	43T00451	RIGHT CABINET ASSEMBLY	33	43T63323	HOLDER,SENSOR
			34	43T19331	FIN GUARD

**13-4. P.C. Board Layout (Outdoor)
RAS-18N3AV-E**

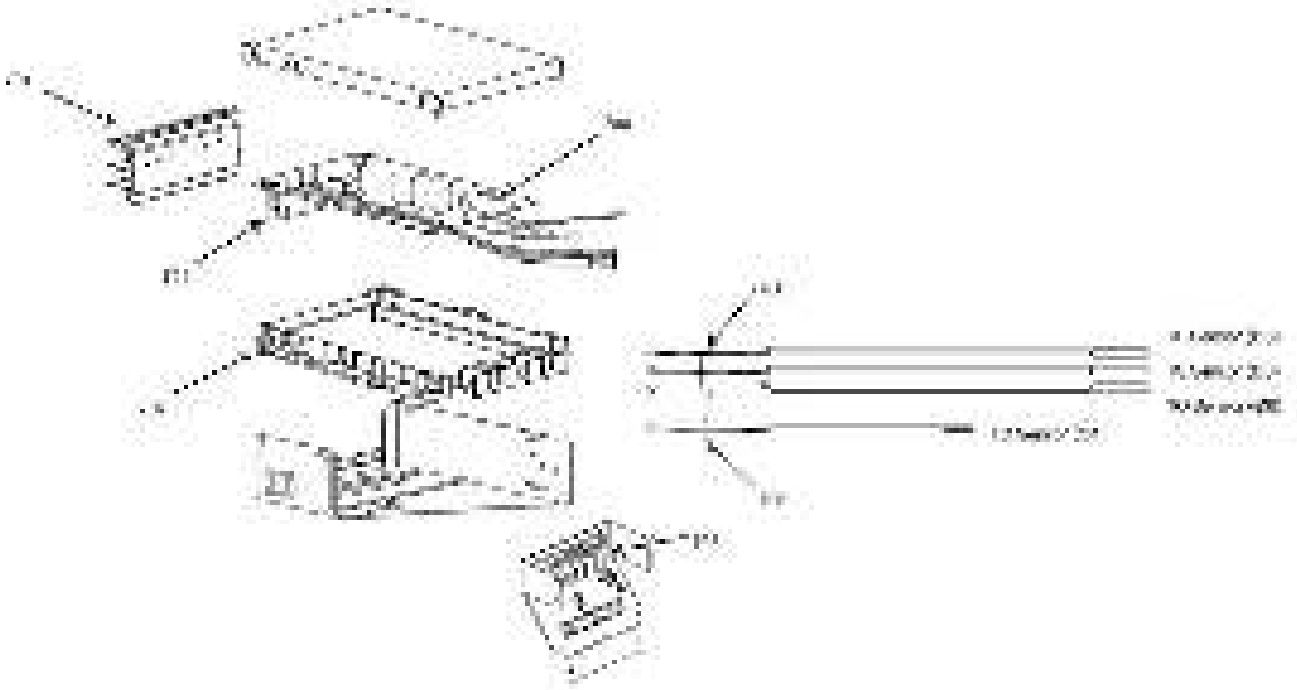

Location No.	Part No.	Description
701	43T62320	HEATSINK
702	43T69943	PC BOARD
703	43T60392	TERMINAL-5P
704	43T60326	FUSE

Location No.	Part No.	Description
705	43T60377	TEMPERATURE SENSOR
706	43T50304	SENSOR;HEAT EXCHANGER
707	43T62313	BASE-PLATE-PC

**13-5. P.C. Board Layout (Outdoor)
RAS-22N3AV-E**

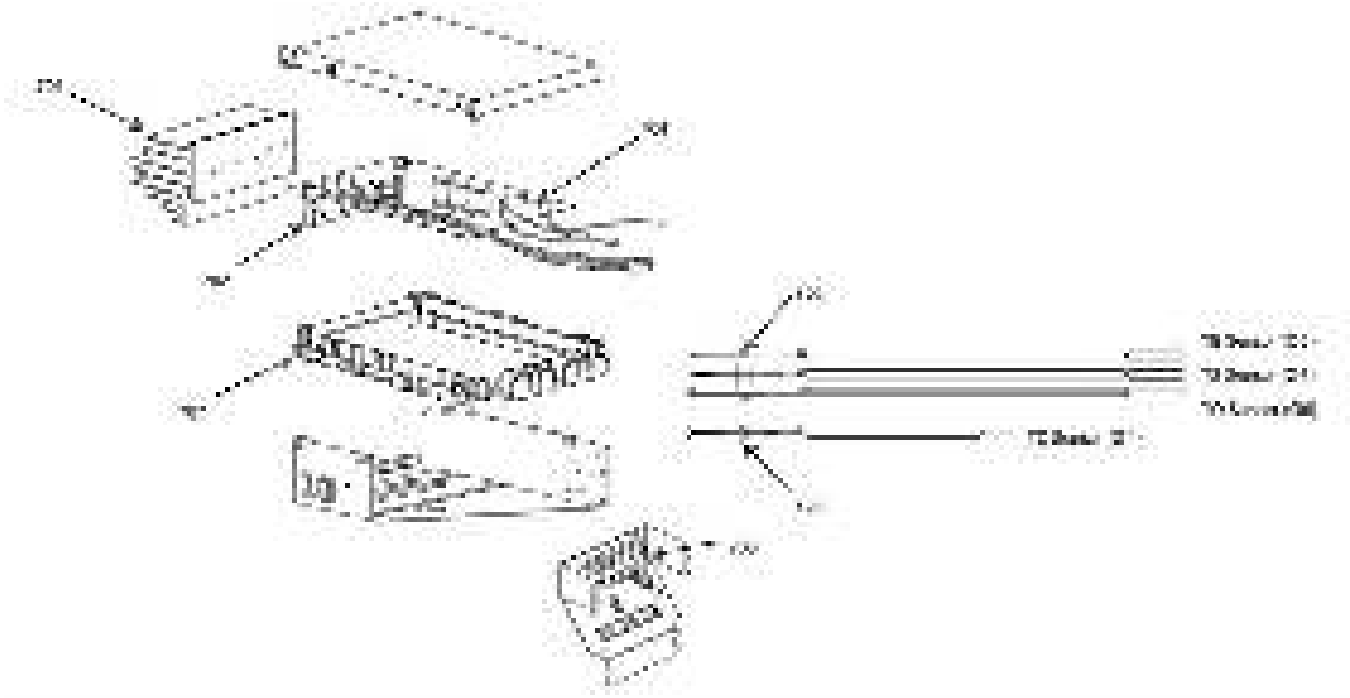

Location No.	Part No.	Description
701	43T62331	HEATSINK
702	43T69881	PC BOARD
703	43T60392	TERMINAL-5P
704	43T60326	FUSE

Location No.	Part No.	Description
705	43T60377	TEMPERATURE SENSOR
706	43T50304	SENSOR;HEAT EXCHANGER
707	43T62313	BASE-PLATE-PC

TOSHIBA CARRIER (THAILAND) CO.,LTD.