

TOSHIBA

SERVICE MANUAL

FILE NO. SVM-12029

AIR CONDITIONER

SPLIT WALL TYPE

RAS-10N3KV-E / RAS-10N3AV-E

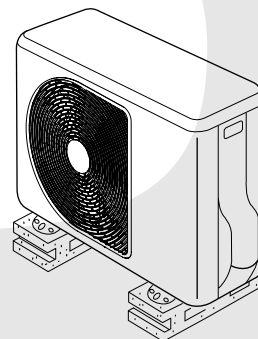
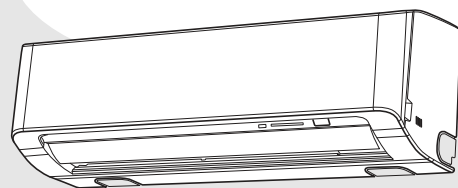

August, 2012

CONTENTS

1. SAFETY PRECAUTIONS	2
2. SPECIFICATIONS	4
3. REFRIGERANT R410A	6
4. CONSTRUCTION VIEWS	14
5. WIRING DIAGRAM	16
6. SPECIFICATIONS OF ELECTRICAL PARTS	18
7. REFRIGERANT CYCLE DIAGRAM	19
8. CONTROL BLOCK DIAGRAM	21
9. OPERATION DESCRIPTION	23
10. INSTALLATION PROCEDURE	46
11. HOW TO DIAGNOSE THE TROUBLE	59
12. HOW TO REPLACE THE MAIN PARTS	79
13. EXPLODED VIEWS AND PARTS LIST	88

1. PRECAUTIONS FOR SAFETY

For general public use

Power supply cord of parts of appliance for outdoor use shall be at least polychloroprene sheathed flexible cord (design H07RN-F) or cord designation 60245 IEC66 (1.5 mm² or more). (Shall be installed in accordance with national wiring regulations.)

CAUTION

New Refrigerant Air Conditioner Installation

- THIS AIR CONDITIONER ADOPTS THE NEW HFC REFRIGERANT (R410A) WHICH DOES NOT DESTROY OZONE LAYER.

R410A refrigerant is apt to be affected by impurities such as water, oxidizing membranes, and oils because the pressure of R410A refrigerant is approx. 1.6 times of refrigerant R22. As well as the adoption of this new refrigerant, refrigerating machine oil has also been changed. Therefore, during installation work, be sure that water, dust, former refrigerant, or refrigerating machine oil does not enter the refrigeration cycle of a new-refrigerant air conditioner. To avoid mixing refrigerant and refrigerating machine oil, the sizes of charging port connecting port connecting sections on the main unit are different from those for the conventional refrigerant, and different size tools are also required. For connecting pipes, use new and clean piping materials with highpressure withstand capabilities, designed for R410A only, and ensure that water or dust does not enter. Moreover, do not use any existing piping as its pressure withstand may be insufficient and may contain impurities.

CAUTION

To disconnect the appliance from the main power supply

This appliance must be connected to the main power supply by means of a circuit breaker or a switch with a contact separation of at least 3 mm in all poles.

The installation circuit breaker must be used specified for the power supply line of this air conditioner.

DANGER

- FOR USE BY QUALIFIED PERSONS ONLY.
- TURN OFF MAIN POWER SUPPLY BEFORE ATTEMPTING ANY ELECTRICAL WORK. MAKE SURE ALL POWER SWITCHES ARE OFF FAILURE TO DO SO MAY CAUSE ELECTRIC SHOCK.
- CONNECT THE CONNECTING CABLE CORRECTLY. IF THE CONNECTING CABLE IS CONNECTED WRONGLY, ELECTRIC PARTS MAY BE DAMAGED.
- CHECK THE EARTH WIRE THAT IT IS NOT BROKEN OR DISCONNECTED BEFORE INSTALLATION.
- DO NOT INSTALL NEAR CONCENTRATIONS OF COMBUSTIBLE GAS OR GAS VAPORS. FAILURE TO FOLLOW THIS INSTRUCTION CAN RESULT IN FIRE OR EXPLOSION.
- TO PREVENT OVERHEATING THE INDOOR UNIT AND CAUSING A FIRE HAZARD, PLACE THE UNIT WELL AWAY (MORE THAN 2 M) FROM HEAT SOURCES SUCH AS RADIATORS, HEATERS, FURNACE, STOVES, ETC.
- WHEN MOVING THE AIR CONDITIONER FOR INSTALLING IT IN ANOTHER PLACE AGAIN, BE VERY CAREFUL NOT TO GET THE SPECIFIED REFRIGERANT (R410A) WITH ANY OTHER GASEOUS BODY INTO THE REFRIGERATION CYCLE. IF AIR OR ANY OTHER GAS IS MIXED IN THE REFRIGERANT, THE GAS PRESSURE IN THE REFRIGERATION CYCLE BECOMES ABNORMALLY HIGH AND IT RESULTINGLY CAUSES BURST OF THE PIPE AND INJURIES ON PERSONS.
- IN THE EVENT THAT THE REFRIGERANT GAS LEAKS OUT OF THE PIPE DURING THE INSTALLATION WORK, IMMEDIATELY LET FRESH AIR INTO THE ROOM. IF THE REFRIGERANT GAS IS HEATED BY FIRE OR SOMETHING ELSE, IT CAUSES GENERATION OF POISONOUS GAS.

WARNING

- Never modify this unit by removing any of the safety guards or bypass or bypass any of the safety interlock switches.
- Do not install in a place which cannot bear the weight of the unit. Personal injury and property damage can result if the unit falls.
- Before doing the electrical work, attach an approved plug to the power supply cord. Also, make sure the equipment is properly earthed.
- Appliance shall be installed in accordance with national wiring regulations. If you detect any damage, do not install the unit. Contact your TOSHIBA dealer immediately.
- Do not use any refrigerant different from the one specified for complement or replacement. Otherwise, abnormally high pressure may be generated in the refrigeration cycle, which may result in a failure or explosion of the product or an injury to your body.

CAUTION

- Exposure of unit to water or other moisture before installation could result in electric shock. Do not store it in a wet basement or expose to rain or water.
- After unpacking the unit, examine it carefully for possible damage.
- Do not install in a place that can increase the vibration of the unit. Do not install in a place that can amplify the noise level of the unit or where noise and discharged air might disturb neighbors.
- To avoid personal injury, be careful when handling parts with sharp edges.
- Please read this installation manual carefully before installing the unit. It contains further important instructions for proper installation.
- The manufacturer shall not assume any liability for the damage caused by not observing the description of this manual.

2. SPECIFICATIONS

2-1. Specifications

Unit model	Indoor		RAS-10N3KV-E			
	Outdoor		RAS-10N3AV-E			
Cooling capacity			(kW)	2.5		
Cooling capacity range			(kW)	1.1 - 3.0		
Heating capacity			(kW)	3.2		
Heating capacity range			(kW)	0.9 - 4.1		
Power supply	1Ph/50Hz/220-240V, 1Ph/60Hz/220V					
Electric characteristic	Indoor	Operation mode		Cooling	Heating	
		Running current	(A)	0.16 - 0.14	0.16 - 0.14	
		Power consumption	(W)	30	30	
		Power factor	(%)	87	87	
	Outdoor	Operation mode		Cooling	Heating	
		Running current	(A)	3.44 - 3.16	3.96 - 3.63	
		Power consumption	(W)	720	830	
		Power factor	(%)	95	95	
Starting current	(A)	4.12				
COP (Cooling / Heating)				3.33/3.72		
Operating noise	Indoor	High	(Cooling / Heating)	(dB-A)	38/40	
		Medium	(Cooling / Heating)	(dB-A)	33/35	
		Low	(Cooling / Heating)	(dB-A)	29/30	
	Outdoor	(Cooling / Heating)		(dB-A)	48/50	
Indoor unit	Unit model		RAS-10N3KV-E			
	Dimension	Height	(mm)	250		
		Width	(mm)	740		
		Depth	(mm)	195		
	Net weight			(kg)	8	
	Fan motor output			(W)	20	
Air flow rate	(Cooling / Heating)		(m ³ / min)	8.7/9.6		
Outdoor unit	Unit model		RAS-10N3AV-E			
	Dimension	Height	(mm)	530		
		Width	(mm)	660		
		Depth	(mm)	240		
	Net weight			(kg)	27	
	Compressor	Motor output			(W)	750
		Type	Single rotary type with DC-inverter variable speed control			
		Model	DA89X1C-23EZ			
Fan motor output			(W)	20		
Air flow rate	(Cooling / Heating)		(m ³ / min)	27/27		
Piping connection	Type		Flare connection			
	Indoor unit	Liquid side	(mm)	Ø6.35		
		Gas side	(mm)	Ø9.52		
	Outdoor unit	Liquid side	(mm)	Ø6.35		
		Gas side	(mm)	Ø9.52		
	Maximum length			(m)	10	
	Maximum charge-less length			(m)	10	
Maximum height difference			(m)	8		
Refrigerant	Name of refrigerant		R410A			
	Weight		(kg)		0.63	
Wiring connection	Power supply		3 Wires: Includes earth (Outdoor)			
	Interconnection		4 Wires: Includes earth			
Usable temperature range	Indoor	(Cooling / Heating)	(°C)	21 - 32/Up to 27		
	Outdoor	(Cooling / Heating)	(°C)	15 - 43/-10 - 24		
Accessory	Indoor unit	Installation plate		1		
		Wireless remote controller		1		
		batteries		2		
		Remote controller holder		1		
		Toshiba New IAQ filter		2		
		Mounting screw		6 (Ø4 x 25L)		
		Flat head wood screw		2 (Ø3.1 x 16L)		
		Installation manual		1		
	Owner's manual		1			
	Outdoor unit	Drain nipple		1		
Water proof rubber cap		2				

* The specification may be subject to change without notice for purpose of improvement.

2-2. Operation Characteristic Curve

< Cooling >

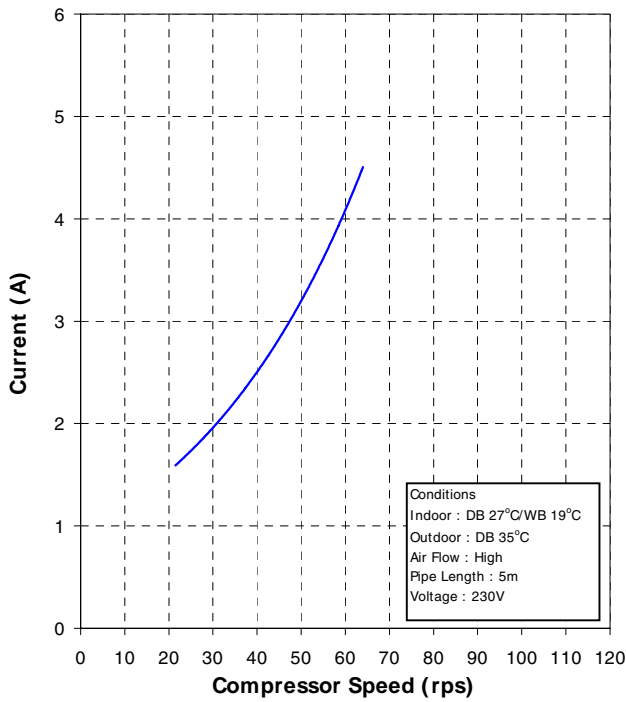

< Heating >

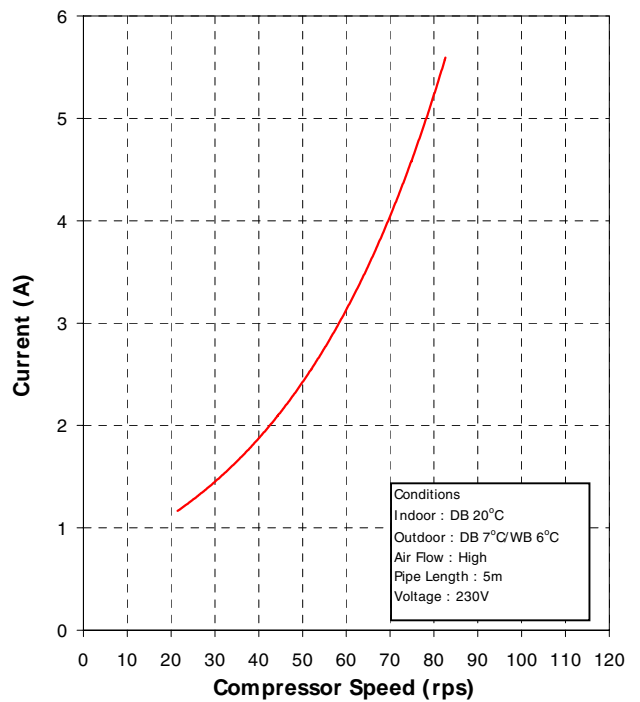

2-3. Capacity Variation Ratio According to Temperature

< Cooling >

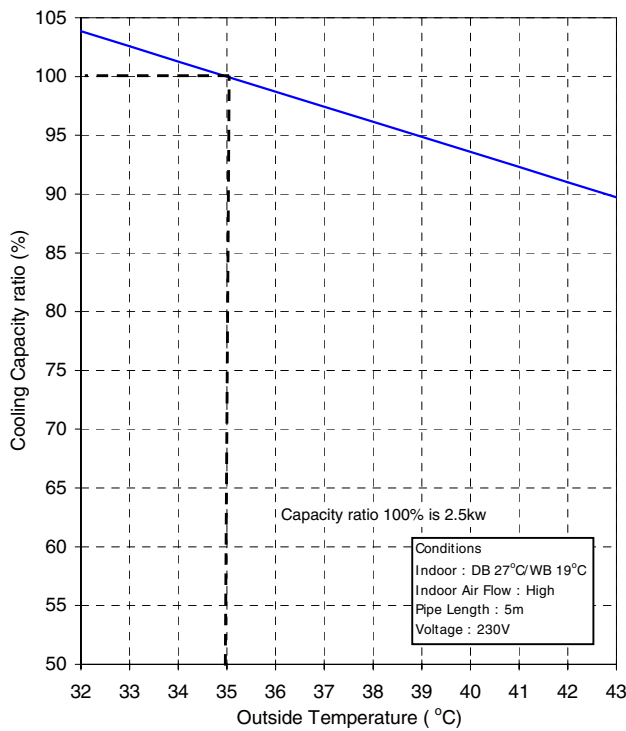

< Heating >

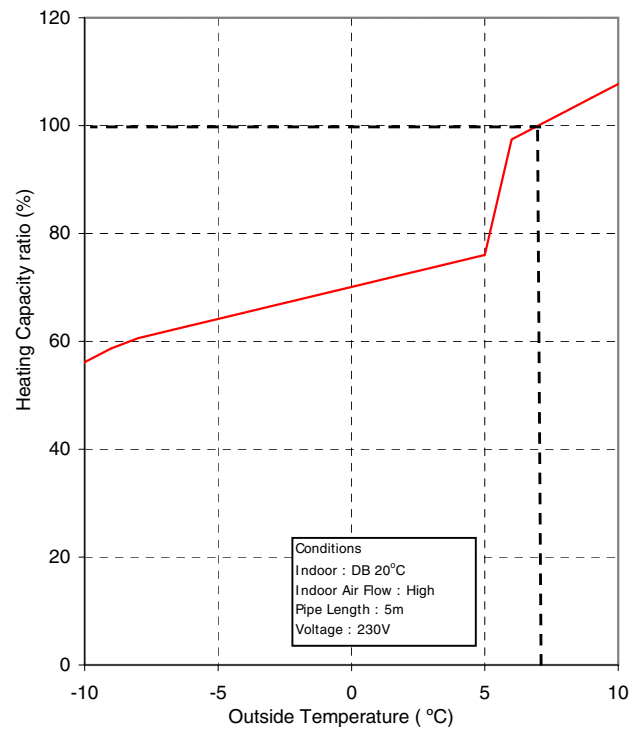

3. REFRIGERANT R410A

This air conditioner adopts the new refrigerant HFC (R410A) which does not damage the ozone layer. The working pressure of the new refrigerant R410A is 1.6 times higher than conventional refrigerant (R22). The refrigerating oil is also changed in accordance with change of refrigerant, so be careful that water, dust, and existing refrigerant or refrigerating oil are not entered in the refrigerant cycle of the air conditioner using the new refrigerant during installation work or servicing time.

The next section describes the precautions for air conditioner using the new refrigerant. Conforming to contents of the next section together with the general cautions included in this manual, perform the correct and safe work.

3-1. Safety During Installation/Serviceing

As R410A's pressure is about 1.6 times higher than that of R22, improper installation/serviceing may cause a serious trouble. By using tools and materials exclusive for R410A, it is necessary to carry out installation/serviceing safely while taking the following precautions into consideration.

1. Never use refrigerant other than R410A in an air conditioner which is designed to operate with R410A.
If other refrigerant than R410A is mixed, pressure in the refrigeration cycle becomes abnormally high, and it may cause personal injury, etc. by a rupture.
2. Confirm the used refrigerant name, and use tools and materials exclusive for the refrigerant R410A.
The refrigerant name R410A is indicated on the visible place of the outdoor unit of the air conditioner using R410A as refrigerant. To prevent mischarging, the diameter of the service port differs from that of R22.
3. If a refrigeration gas leakage occurs during installation/serviceing, be sure to ventilate fully.
If the refrigerant gas comes into contact with fire, a poisonous gas may occur.
4. When installing or removing an air conditioner, do not allow air or moisture to remain in the refrigeration cycle. Otherwise, pressure in the refrigeration cycle may become abnormally high so that a rupture or personal injury may be caused.
5. After completion of installation work, check to make sure that there is no refrigeration gas leakage.
If the refrigerant gas leaks into the room, coming into contact with fire in the fan-driven heater, space heater, etc., a poisonous gas may occur.

6. When an air conditioning system charged with a large volume of refrigerant is installed in a small room, it is necessary to exercise care so that, even when refrigerant leaks, its concentration does not exceed the marginal level.
If the refrigerant gas leakage occurs and its concentration exceeds the marginal level, an oxygen starvation accident may result.
7. Be sure to carry out installation or removal according to the installation manual.
Improper installation may cause refrigeration trouble, water leakage, electric shock, fire, etc.
8. Unauthorized modifications to the air conditioner may be dangerous. If a breakdown occurs please call a qualified air conditioner technician or electrician.
Improper repair's may result in water leakage, electric shock and fire, etc.

3-2. Refrigerant Piping Installation

3-2-1. Piping Materials and Joints Used

For the refrigerant piping installation, copper pipes and joints are mainly used. Copper pipes and joints suitable for the refrigerant must be chosen and installed. Furthermore, it is necessary to use clean copper pipes and joints whose interior surfaces are less affected by contaminants.

1. Copper Pipes

It is necessary to use seamless copper pipes which are made of either copper or copper alloy and it is desirable that the amount of residual oil is less than 40 mg/10 m. Do not use copper pipes having a collapsed, deformed or discolored portion (especially on the interior surface).

Otherwise, the expansion valve or capillary tube may become blocked with contaminants.

As an air conditioner using R410A incurs pressure higher than when using R22, it is necessary to choose adequate materials.

Thicknesses of copper pipes used with R410A are as shown in Table 3-2-1. Never use copper pipes thinner than 0.8 mm even when it is available on the market.

Table 3-2-1 Thicknesses of annealed copper pipes

		Thickness (mm)	
Nominal diameter	Outer diameter (mm)	R410A	R22
1/4	6.35	0.80	0.80
3/8	9.52	0.80	0.80
1/2	12.70	0.80	0.80
5/8	15.88	1.00	1.00

2. Joints

For copper pipes, flare joints or socket joints are used. Prior to use, be sure to remove all contaminants.

a) Flare Joints

Flare joints used to connect the copper pipes cannot be used for pipings whose outer diameter exceeds 20 mm. In such a case, socket joints can be used.

Sizes of flare pipe ends, flare joint ends and flare nuts are as shown in Tables 3-2-3 to 3-2-6 below.

b) Socket Joints

Socket joints are such that they are brazed for connections, and used mainly for thick pipings whose diameter is larger than 20 mm.

Thicknesses of socket joints are as shown in Table 3-2-2.

Table 3-2-2 Minimum thicknesses of socket joints

Nominal diameter	Reference outer diameter of copper pipe jointed (mm)	Minimum joint thickness (mm)
1/4	6.35	0.50
3/8	9.52	0.60
1/2	12.70	0.70
5/8	15.88	0.80

3-2-2. Processing of Piping Materials

When performing the refrigerant piping installation, care should be taken to ensure that water or dust does not enter the pipe interior, that no other oil than lubricating oils used in the installed air-water heat pump is used, and that refrigerant does not leak. When using lubricating oils in the piping processing, use such lubricating oils whose water content has been removed. When stored, be sure to seal the container with an airtight cap or any other cover.

1. Flare processing procedures and precautions

a) Cutting the Pipe

By means of a pipe cutter, slowly cut the pipe so that it is not deformed.

b) Removing Burrs and Chips

If the flared section has chips or burrs, refrigerant leakage may occur.

Carefully remove all burrs and clean the cut surface before installation.

c) Insertion of Flare Nut

d) Flare Processing

Make certain that a clamp bar and copper pipe have been cleaned.

By means of the clamp bar, perform the flare processing correctly.

Use either a flare tool for R410A or conventional flare tool.

Flare processing dimensions differ according to the type of flare tool. When using a conventional flare tool, be sure to secure "dimension A" by using a gauge for size adjustment.

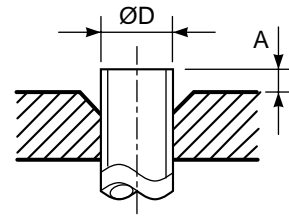

Fig. 3-2-1 Flare processing dimensions

Table 3-2-3 Dimensions related to flare processing for R410A

Nominal diameter	Outer diameter (mm)	Thickness (mm)	A (mm)		
			Flare tool for R410A clutch type	Conventional flare tool	
				Clutch type	Wing nut type
1/4	6.35	0.8	0 to 0.5	1.0 to 1.5	1.5 to 2.0
3/8	9.52	0.8	0 to 0.5	1.0 to 1.5	1.5 to 2.0
1/2	12.70	0.8	0 to 0.5	1.0 to 1.5	2.0 to 2.5
5/8	15.88	1.0	0 to 0.5	1.0 to 1.5	2.0 to 2.5

Table 3-2-4 Dimensions related to flare processing for R22

Nominal diameter	Outer diameter (mm)	Thickness (mm)	A (mm)		
			Flare tool for R22 clutch type	Conventional flare tool	
				Clutch type	Wing nut type
1/4	6.35	0.8	0 to 0.5	0.5 to 1.0	1.0 to 1.5
3/8	9.52	0.8	0 to 0.5	0.5 to 1.0	1.0 to 1.5
1/2	12.70	0.8	0 to 0.5	0.5 to 1.0	1.5 to 2.0
5/8	15.88	1.0	0 to 0.5	0.5 to 1.0	1.5 to 2.0

Table 3-2-5 Flare and flare nut dimensions for R410A

Nominal diameter	Outer diameter (mm)	Thickness (mm)	Dimension (mm)				Flare nut width (mm)
			A	B	C	D	
1/4	6.35	0.8	9.1	9.2	6.5	13	17
3/8	9.52	0.8	13.2	13.5	9.7	20	22
1/2	12.70	0.8	16.6	16.0	12.9	23	26
5/8	15.88	1.0	19.7	19.0	16.0	25	29

Table 3-2-6 Flare and flare nut dimensions for R22

Nominal diameter	Outer diameter (mm)	Thickness (mm)	Dimension (mm)				Flare nut width (mm)
			A	B	C	D	
1/4	6.35	0.8	9.0	9.2	6.5	13	17
3/8	9.52	0.8	13.0	13.5	9.7	20	22
1/2	12.70	0.8	16.2	16.0	12.9	20	24
5/8	15.88	1.0	19.7	19.0	16.0	23	27
3/4	19.05	1.0	23.3	24.0	19.2	34	36

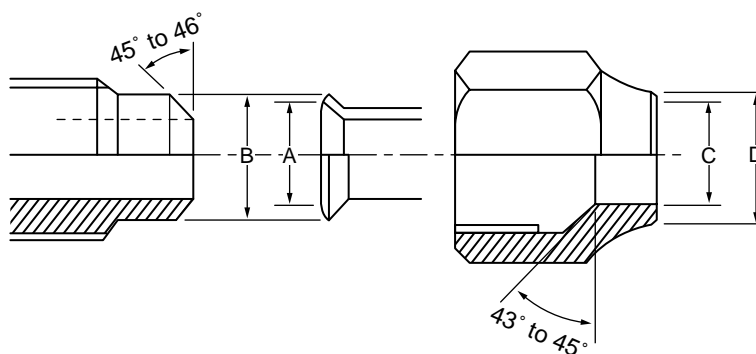

Fig. 3-2-2 Relations between flare nut and flare seal surface

2. Flare Connecting Procedures and Precautions

- Make sure that the flare and union portions do not have any scar or dust, etc.
- Correctly align the processed flare surface with the union axis.
- Tighten the flare with designated torque by means of a torque wrench. The tightening torque for R410A is the same as that for conventional R22. Incidentally, when the torque is weak, the gas leakage may occur. When it is strong, the flare nut may crack and may be made non-removable. When choosing the tightening torque, comply with values designated by manufacturers. Table 3-2-7 shows reference values.

NOTE :

When applying oil to the flare surface, be sure to use oil designated by the manufacturer. If any other oil is used, the lubricating oils may deteriorate and cause the compressor to burn out.

Table 3-2-7 Tightening torque of flare for R410A [Reference values]

Nominal diameter	Outer diameter (mm)	Tightening torque N•m (kgf•cm)	Tightening torque of torque wrenches available on the market N•m (kgf•cm)
1/4	6.35	14 to 18 (140 to 180)	16 (160), 18 (180)
3/8	9.52	33 to 42 (330 to 420)	42 (420)
1/2	12.70	50 to 62 (500 to 620)	55 (550)
5/8	15.88	63 to 77 (630 to 770)	65 (650)

3-3. Tools

3-3-1. Required Tools

The service port diameter of packed valve of the outdoor unit in the air-water heat pump using R410A is changed to prevent mixing of other refrigerant. To reinforce the pressure-resisting strength, flare processing dimensions and opposite side dimension of flare nut (For Ø12.7 copper pipe) of the refrigerant piping are lengthened.

The used refrigerating oil is changed, and mixing of oil may cause a trouble such as generation of sludge, clogging of capillary, etc. Accordingly, the tools to be used are classified into the following three types.

1. Tools exclusive for R410A (Those which cannot be used for conventional refrigerant (R22))
2. Tools exclusive for R410A, but can be also used for conventional refrigerant (R22)
3. Tools commonly used for R410A and for conventional refrigerant (R22)

The table below shows the tools exclusive for R410A and their interchangeability.

Tools whose specifications are changed for R410A and their interchangeability

No.	Used tool	Usage	R410A air-water heat pump installation		Conventional air-water heat pump installation
			Existence of new equipment for R410A	Whether conven- tional equipment can be used	Whether new equipment can be used with conventional refrigerant
1	Flare tool	Pipe flaring	Yes	*(Note 1)	○
2	Copper pipe gauge for adjusting projection margin	Flaring by conventional flare tool	Yes	*(Note 1)	*(Note 1)
3	Torque wrench (For Ø12.7)	Connection of flare nut	Yes	×	×
4	Gauge manifold	Evacuating, refrigerant charge, run check, etc.	Yes	×	×
5	Charge hose				
6	Vacuum pump adapter	Vacuum evacuating	Yes	×	○
7	Electronic balance for refrigerant charging	Refrigerant charge	Yes	×	○
8	Refrigerant cylinder	Refrigerant charge	Yes	×	×
9	Leakage detector	Gas leakage check	Yes	×	○
10	Charging cylinder	Refrigerant charge	(Note 2)	×	×

(Note 1) When flaring is carried out for R410A using the conventional flare tools, adjustment of projection margin is necessary. For this adjustment, a copper pipe gauge, etc. are necessary.

(Note 2) Charging cylinder for R410A is being currently developed.

In addition to the above exclusive tools, the following equipments which serve also for R22 are necessary as the general tools.

- | | | |
|--|-----------------------------|---|
| 1. Vacuum pump
Use vacuum pump by attaching
vacuum pump adapter. | 4. Reamer | 9. Hole core drill (Ø65) |
| 2. Torque wrench (For Ø6.35, Ø9.52) | 5. Pipe bender | 10. Hexagon wrench
(Opposite side 4mm) |
| 3. Pipe cutter | 6. Level vial | 11. Tape measure |
| | 7. Screwdriver (+, -) | 12. Metal saw |
| | 8. Spanner or Monkey wrench | |

Also prepare the following equipments for other installation method and run check.

- | | |
|----------------|---------------------------------|
| 1. Clamp meter | 3. Insulation resistance tester |
| 2. Thermometer | 4. Electroscopes |

3-4. Recharging of Refrigerant

When it is necessary to recharge refrigerant, charge the specified amount of new refrigerant according to the following steps.

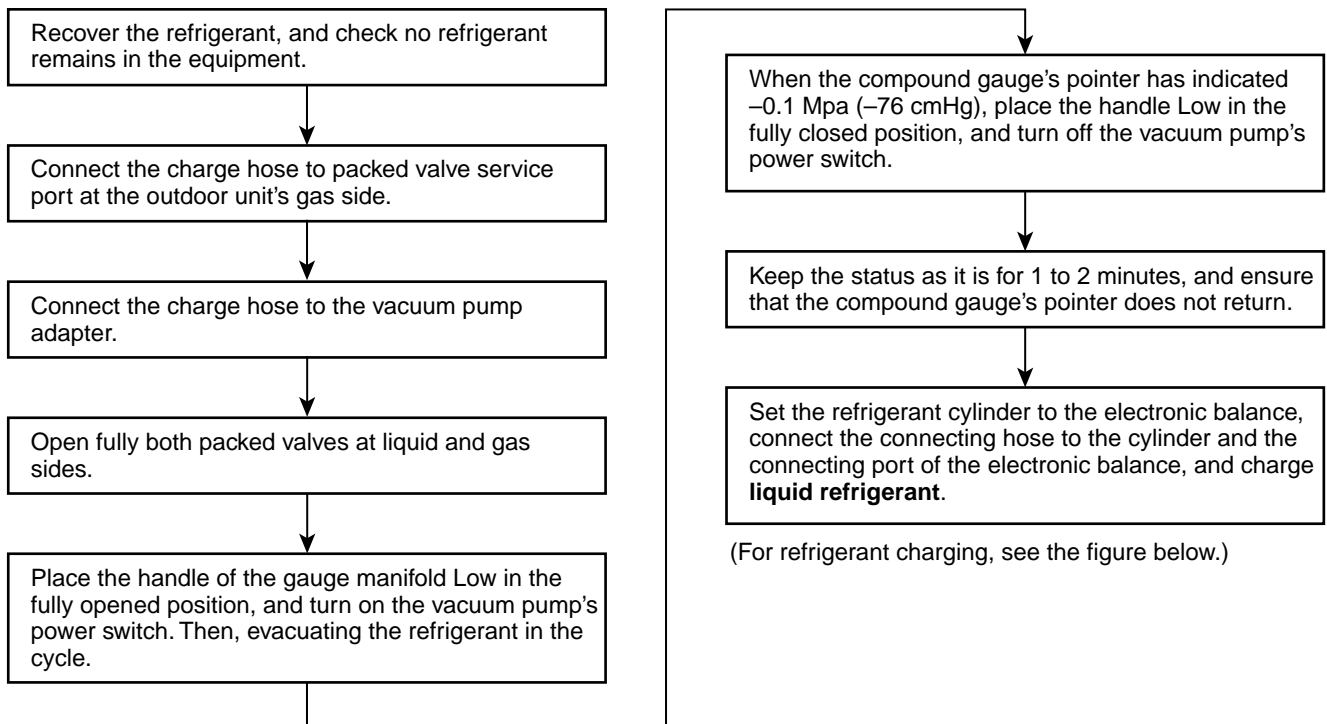

1. Never charge refrigerant exceeding the specified amount.
2. If the specified amount of refrigerant cannot be charged, charge refrigerant **bit by bit** in COOL mode.
3. Do not carry out additional charging.

When additional charging is carried out if refrigerant leaks, the refrigerant composition changes in the refrigeration cycle, that is characteristics of the air conditioner changes, refrigerant exceeding the specified amount is charged, and working pressure in the refrigeration cycle becomes abnormally high pressure, and may cause a rupture or personal injury.

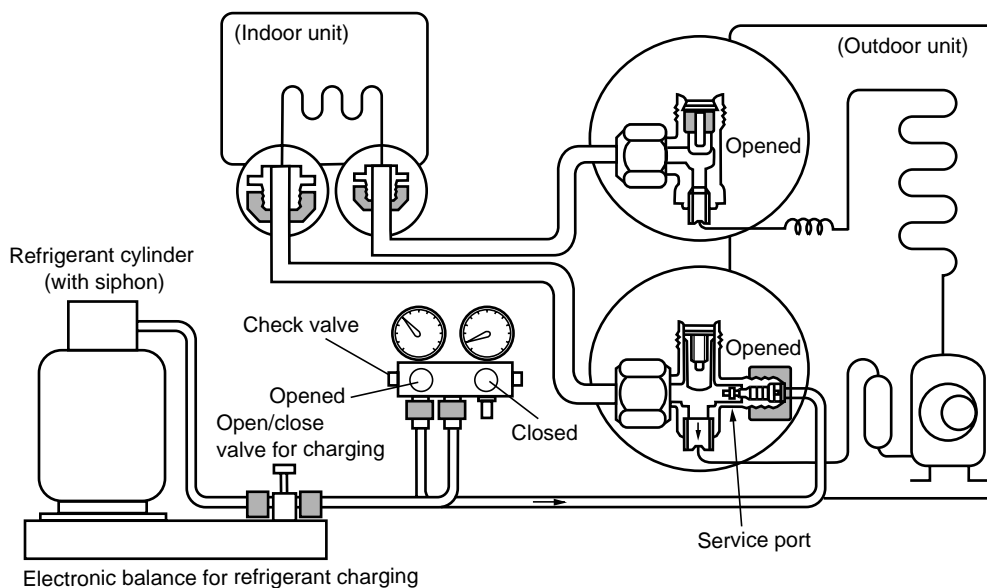
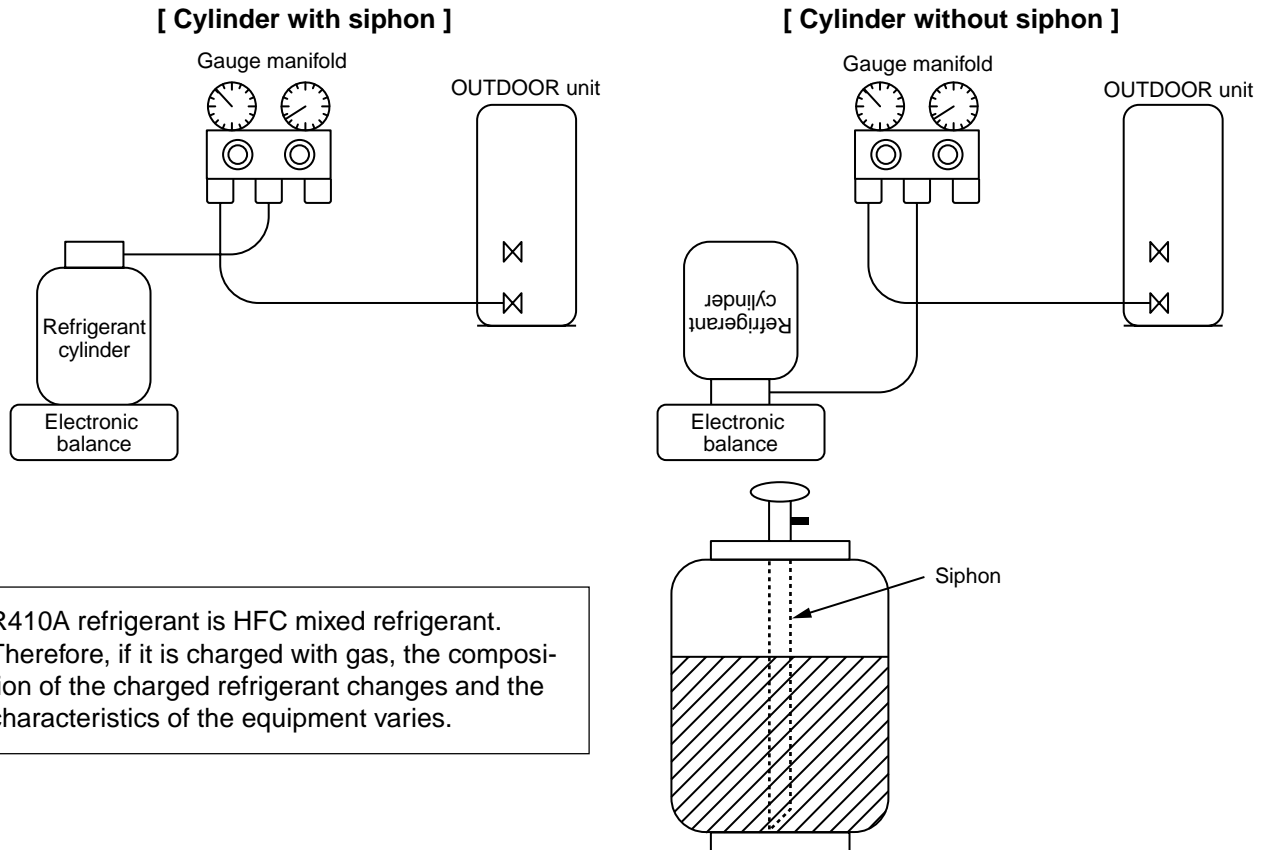

Fig. 3-4-1 Configuration of refrigerant charging

1. Be sure to make setting so that **liquid** can be charged.
2. When using a cylinder equipped with a siphon, liquid can be charged without turning it upside down.

It is necessary for charging refrigerant under condition of liquid because R410A is mixed type of refrigerant. Accordingly, when charging refrigerant from the refrigerant cylinder to the equipment, charge it turning the cylinder upside down if cylinder is not equipped with siphon.



R410A refrigerant is HFC mixed refrigerant. Therefore, if it is charged with gas, the composition of the charged refrigerant changes and the characteristics of the equipment varies.

Fig. 3-4-2

3-5. Brazing of Pipes

3-5-1. Materials for Brazing

1. Silver brazing filler

Silver brazing filler is an alloy mainly composed of silver and copper. It is used to join iron, copper or copper alloy, and is relatively expensive though it excels in solderability.

2. Phosphor bronze brazing filler

Phosphor bronze brazing filler is generally used to join copper or copper alloy.

3. Low temperature brazing filler

Low temperature brazing filler is generally called solder, and is an alloy of tin and lead. Since it is weak in adhesive strength, do not use it for refrigerant pipes.

1. Phosphor bronze brazing filler tends to react with sulfur and produce a fragile compound water solution, which may cause a gas leakage. Therefore, use any other type of brazing filler at a hot spring resort, etc., and coat the surface with a paint.
2. When performing brazing again at time of servicing, use the same type of brazing filler.

3-5-2. Flux

1. Reason why flux is necessary

- By removing the oxide film and any foreign matter on the metal surface, it assists the flow of brazing filler.
- In the brazing process, it prevents the metal surface from being oxidized.
- By reducing the brazing filler's surface tension, the brazing filler adheres better to the treated metal.

2. Characteristics required for flux

- Activated temperature of flux coincides with the brazing temperature.
- Due to a wide effective temperature range, flux is hard to carbonize.
- It is easy to remove slag after brazing.
- The corrosive action to the treated metal and brazing filler is minimum.
- It excels in coating performance and is harmless to the human body.

As the flux works in a complicated manner as described above, it is necessary to select an adequate type of flux according to the type and shape of treated metal, type of brazing filler and brazing method, etc.

3. Types of flux

• Noncorrosive flux

Generally, it is a compound of borax and boric acid.

It is effective in case where the brazing temperature is higher than 800°C.

• Activated flux

Most of fluxes generally used for silver brazing are this type.

It features an increased oxide film removing capability due to the addition of compounds such as potassium fluoride, potassium chloride and sodium fluoride to the borax-boric acid compound.

4. Piping materials for brazing and used brazing filler/flux

Piping material	Used brazing filler	Used flux
Copper - Copper	Phosphor copper	Do not use
Copper - Iron	Silver	Paste flux
Iron - Iron	Silver	Vapor flux

1. Do not enter flux into the refrigeration cycle.
2. When chlorine contained in the flux remains within the pipe, the lubricating oil deteriorates. Therefore, use a flux which does not contain chlorine.
3. When adding water to the flux, use water which does not contain chlorine (e.g. distilled water or ion-exchange water).
4. Remove the flux after brazing.

3-5-3. Brazing

As brazing work requires sophisticated techniques, experiences based upon a theoretical knowledge, it must be performed by a person qualified.

In order to prevent the oxide film from occurring in the pipe interior during brazing, it is effective to proceed with brazing while letting dry Nitrogen gas (N₂) flow.

Never use gas other than Nitrogen gas.

1. Brazing method to prevent oxidation

- 1) Attach a reducing valve and a flow-meter to the Nitrogen gas cylinder.
- 2) Use a copper pipe to direct the piping material, and attach a flow-meter to the cylinder.
- 3) Apply a seal onto the clearance between the piping material and inserted copper pipe for Nitrogen in order to prevent backflow of the Nitrogen gas.
- 4) When the Nitrogen gas is flowing, be sure to keep the piping end open.
- 5) Adjust the flow rate of Nitrogen gas so that it is lower than 0.05 m³/Hr or 0.02 MPa (0.2kgf/cm²) by means of the reducing valve.
- 6) After performing the steps above, keep the Nitrogen gas flowing until the pipe cools down to a certain extent (temperature at which pipes are touchable with hands).
- 7) Remove the flux completely after brazing.

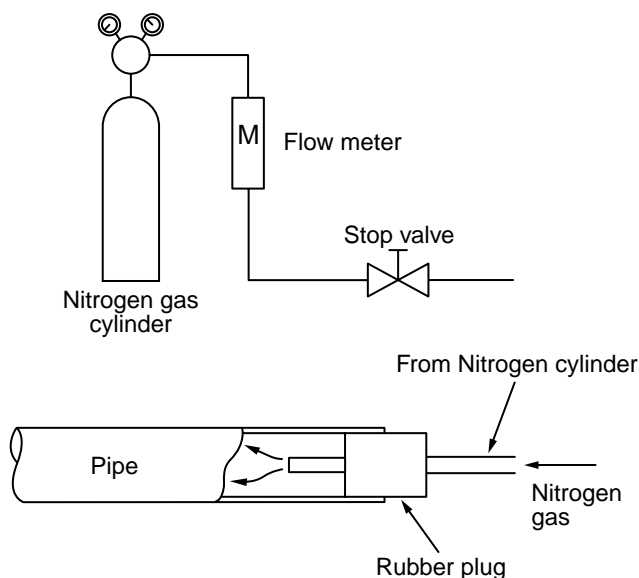
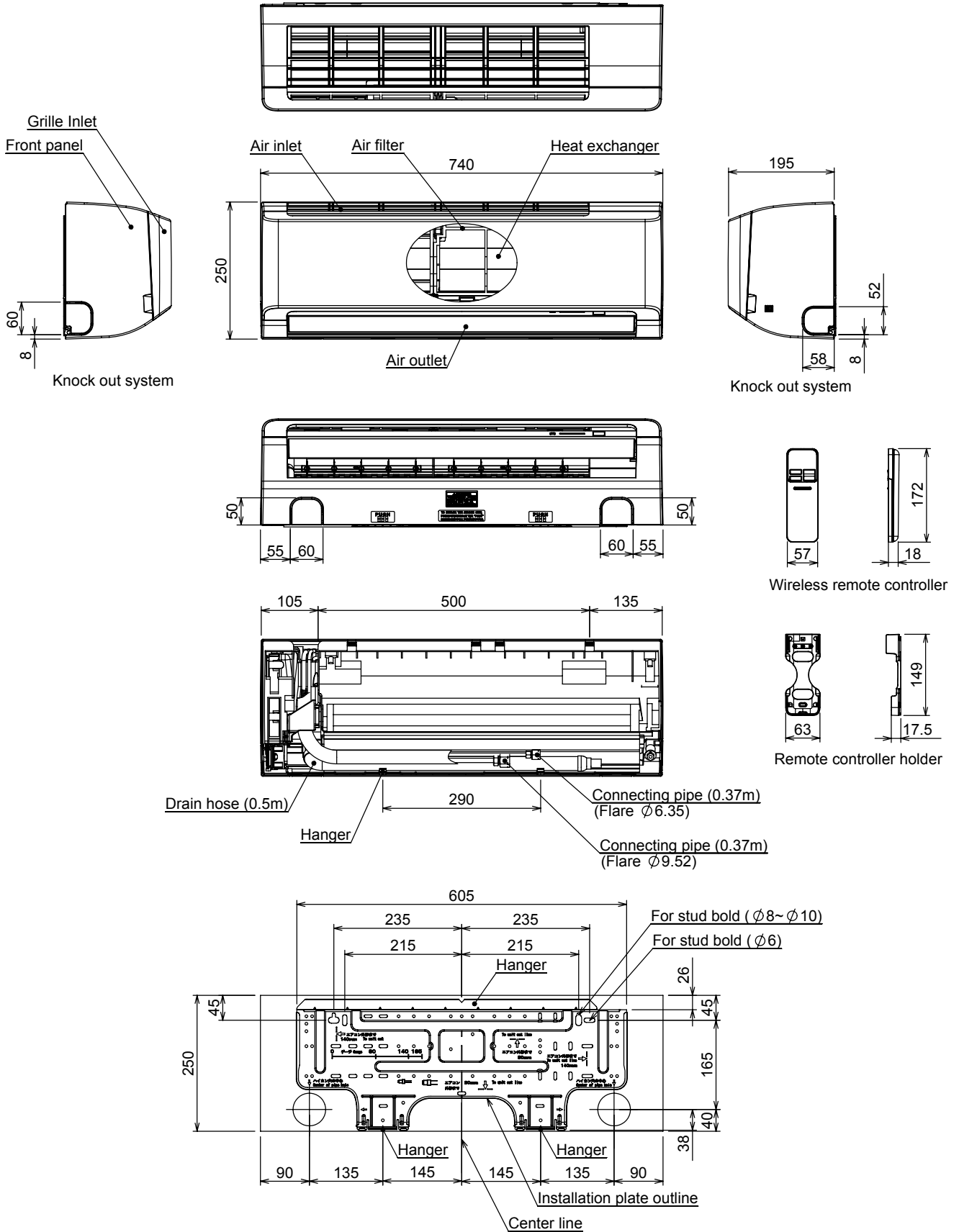

Fig. 3-5-1 Prevention of oxidation during brazing

4. CONSTRUCTION VIEWS

4-1. Indoor Unit



4-2. Outdoor Unit

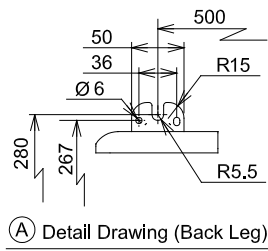

(A) Detail Drawing (Back Leg)

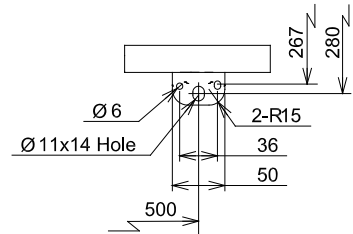
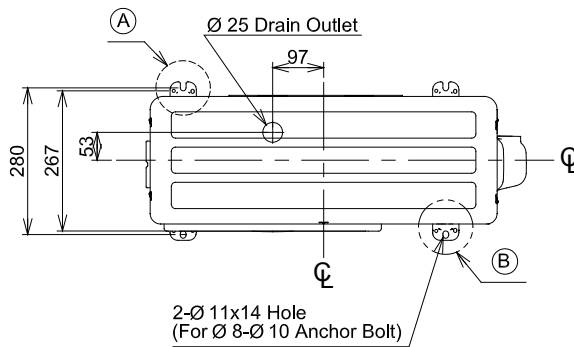

(B) Detail Drawing (Front Leg)

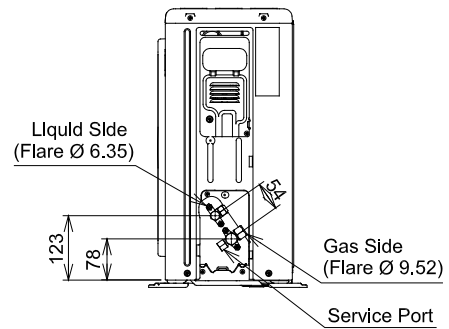
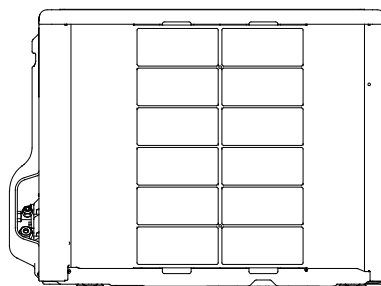
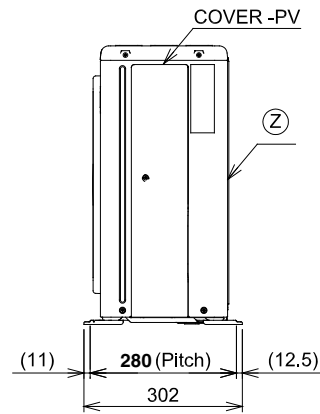
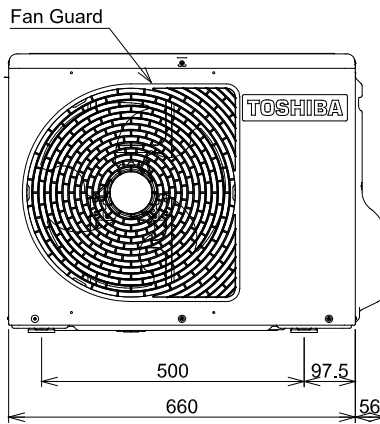
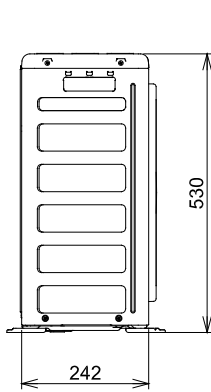

Installation Dimension

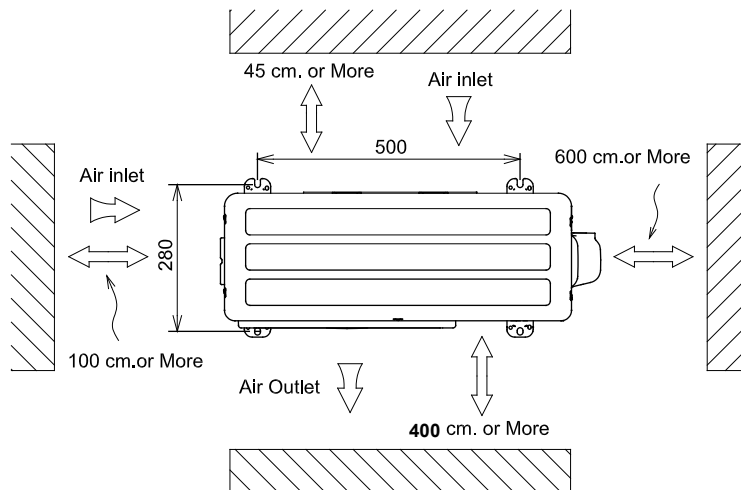

(Z) View

5. WIRING DIAGRAM

5-1. Indoor Unit

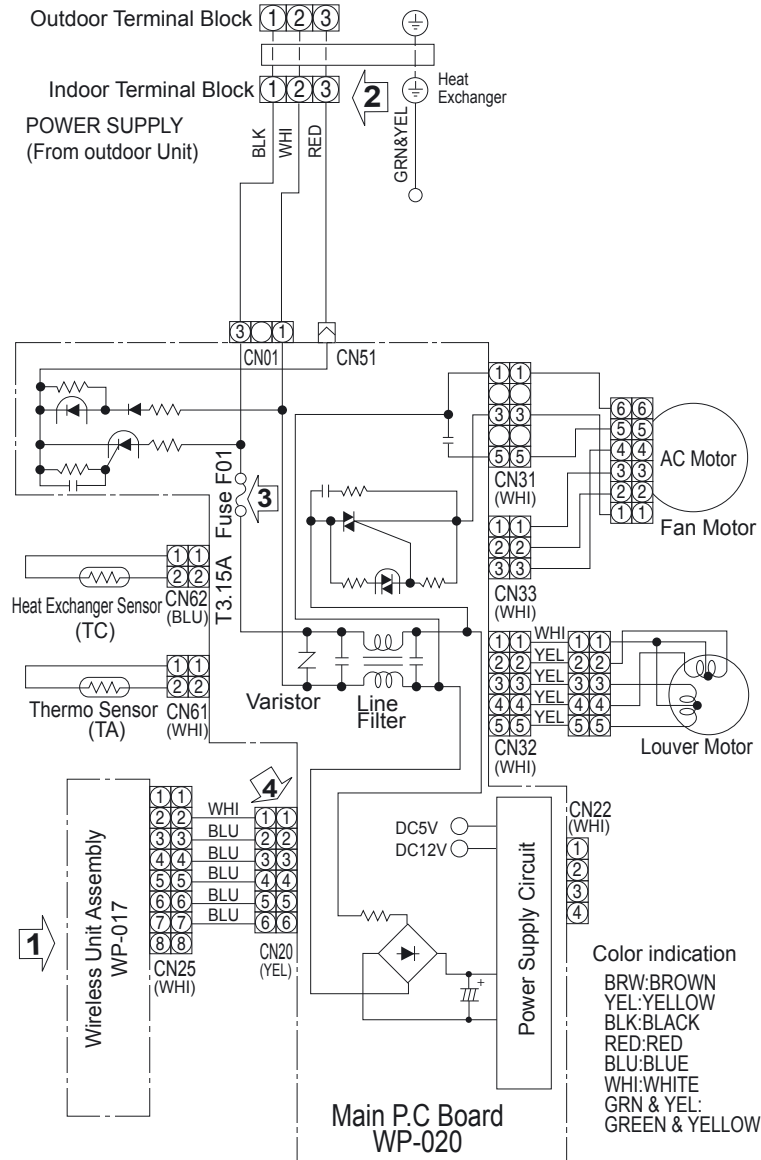

Quick check for diagnosing faults

Check Items	Diagnosis result
① OPERATION indicator	Check to see if the OPERATION indicator goes on & off when the main switch or circuit breakers turned on, or power cord is plugged in the wall outlet.
② Terminal block	Check for the voltage between ① and ② is 220 to 240VAC. Check for the voltage between ② and ③ is 15 to 60VDC.
③ Fuse 3.15A	Check Varistor if the fuse is open.
④ DC5V	Check for the voltage between ② and ③ terminal of CN20.

5-2. Outdoor Unit

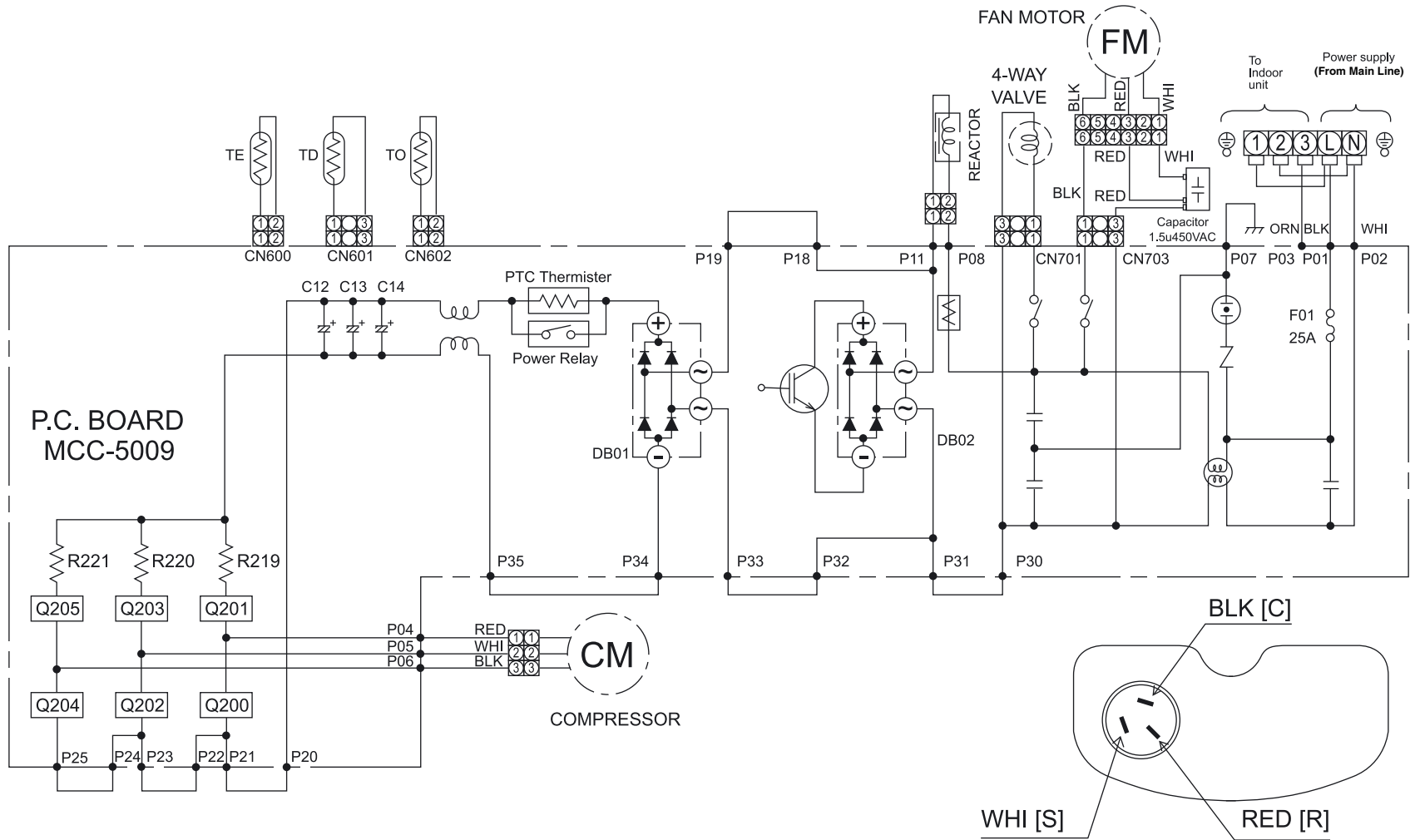

6. SPECIFICATION OF ELECTRICAL PARTS

6-1. Indoor Unit

No.	Parts name	Type	Specifications
1	Fan motor (for indoor)	AFN-220-20-4D	AC 240V, 20W
2	Room temp. sensor (TA-sensor)	(-)	10k Ω at 25°C
3	Heat exchanger temp. sensor (TC-sensor)	(-)	10k Ω at 25°C
4	Louver motor	MP24ZCT	Output (Rated) 1W, 16 poles, DC12V

6-2. Outdoor Unit

No.	Parts name	Type	Specifications
1	Reactor	CH-69	L = 19mH, 10A
2	Outdoor fan motor	WLF-240-20A-1	AC 240V, 20W
3	Suction temp. sensor (TS sensor)	(Inverter attached)	10k Ω (25°C)
4	Discharge temp. sensor (TD sensor)	(Inverter attached)	62k Ω (20°C)
5	Outside air temp. sensor (TO sensor)	(Inverter attached)	10k Ω (25°C)
6	Heat exchanger temp. sensor (TE sensor)	(Inverter attached)	10k Ω (25°C)
7	Terminal block (5P)	—————	20A, AC250V
8	Compressor	DA89X1C-23EZ	3-phases 4-poles 750W
9	Coil for 4-way valve	STF	AC220-240V

7. REFRIGERANT CYCLE DIAGRAM

7-1. Refrigerant Cycle Diagram

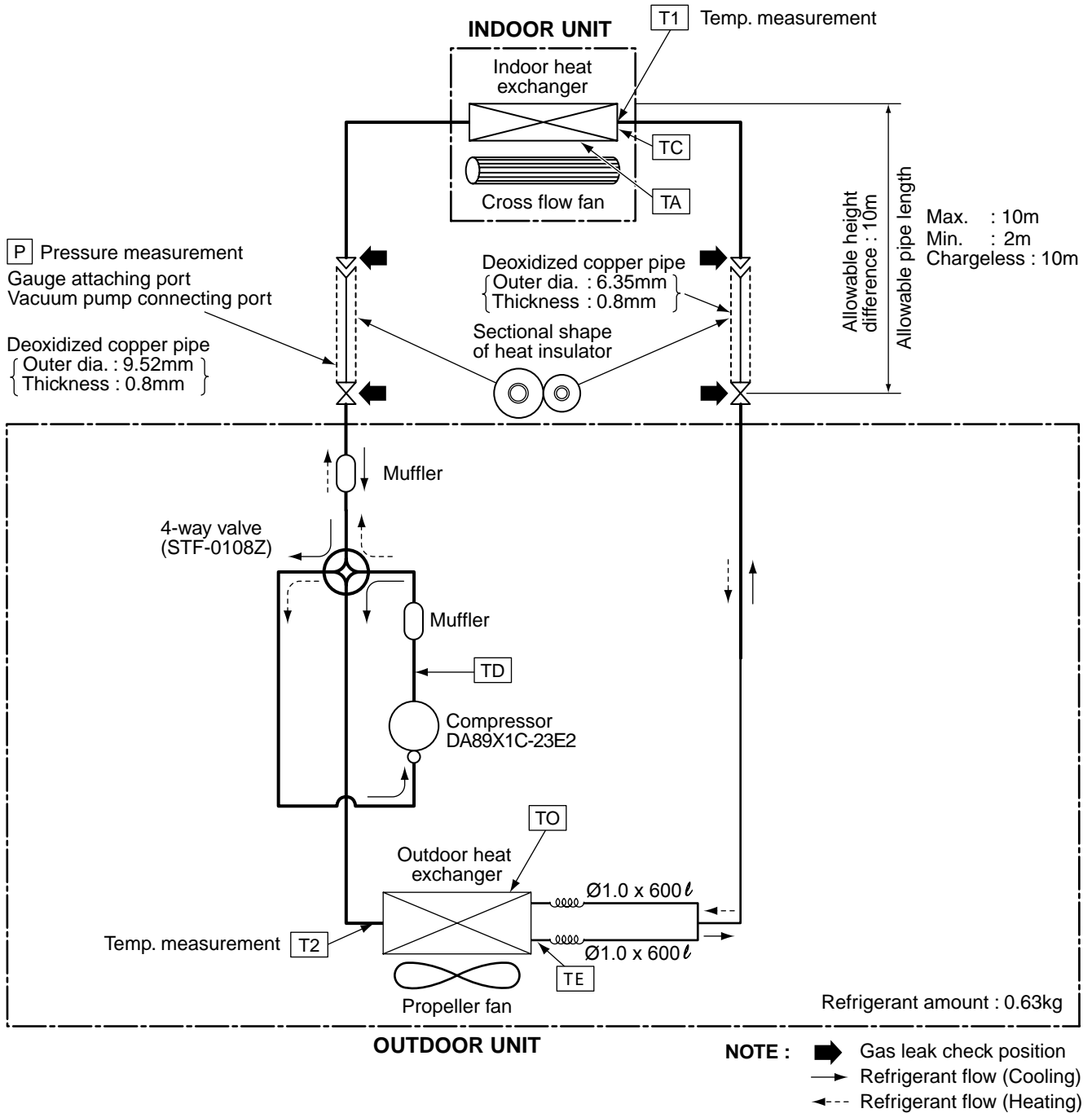

NOTE :

- The maximum pipe length of this air conditioner is 10 m. The addition charging of refrigerant is unnecessary because this air conditioner is designed with charge-less specification.

7-2. Operation Data**<Cooling>**

Temperature condition(°C)		Standard pressure P (MPa)	Heat exchanger pipe temp.		Indoor fan mode	Outdoor fan mode	Compressor revolution (rps)
Indoor	Outdoor		T1 (°C)	T2 (°C)			
27/19	35/-	0.9 to 1.1	9 to 11	47 to 49	High	High	54

<Heating>

Temperature condition(°C)		Standard pressure P (MPa)	Heat exchanger pipe temp.		Indoor fan mode	Outdoor fan mode	Compressor revolution (rps)
Indoor	Outdoor		T1 (°C)	T2 (°C)			
20/-	7/6	2.4 to 2.6	43 to 45	0 to 3	High	High	68

NOTES :

1. Measure surface temperature of heat exchanger pipe around center of heat exchanger path U bent.
(Thermistor thermometer)
2. Connecting piping condition 5 m

8. CONTROL BLOCK DIAGRAM

8-1. Indoor Unit

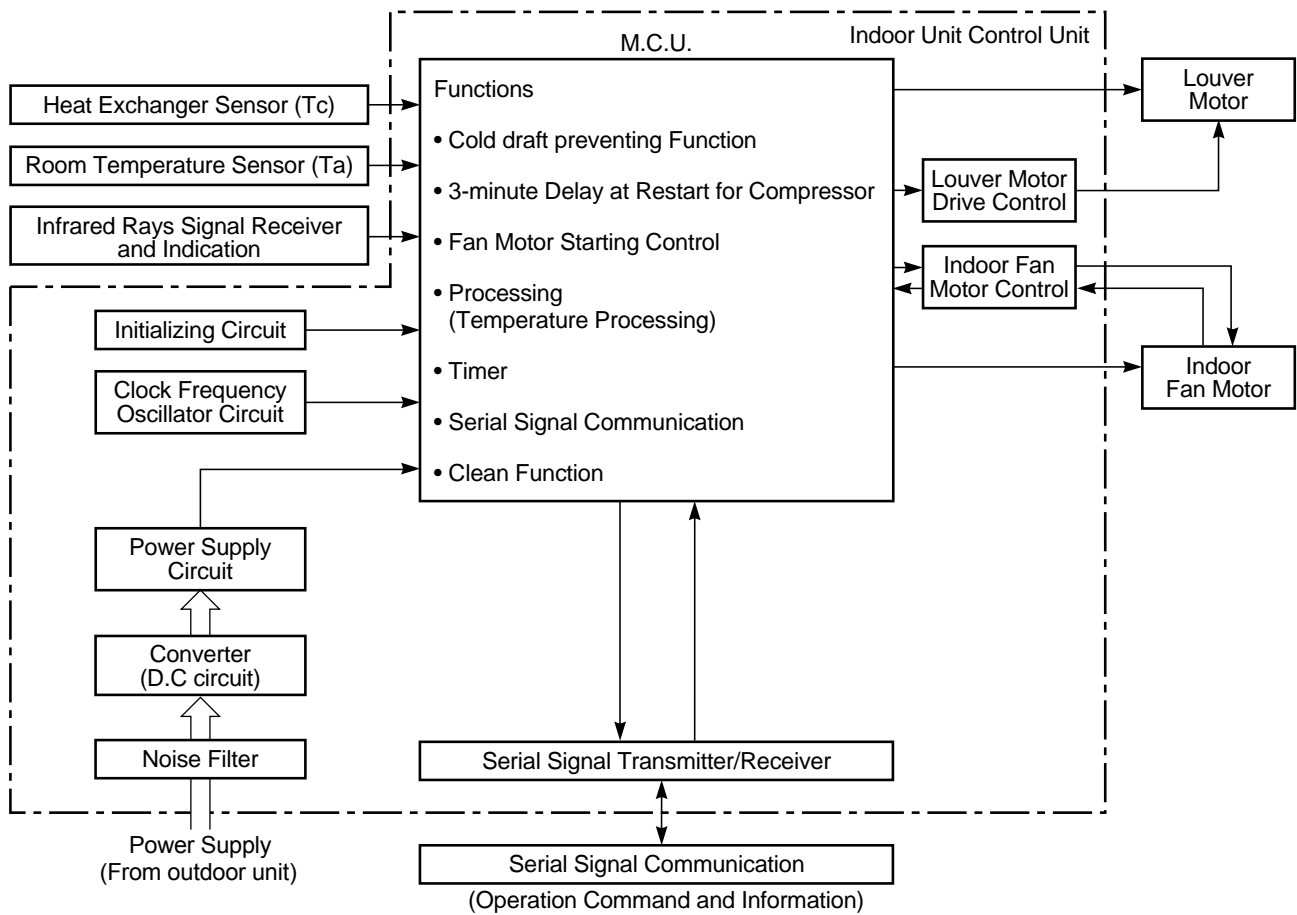

REMOTE CONTROLLER

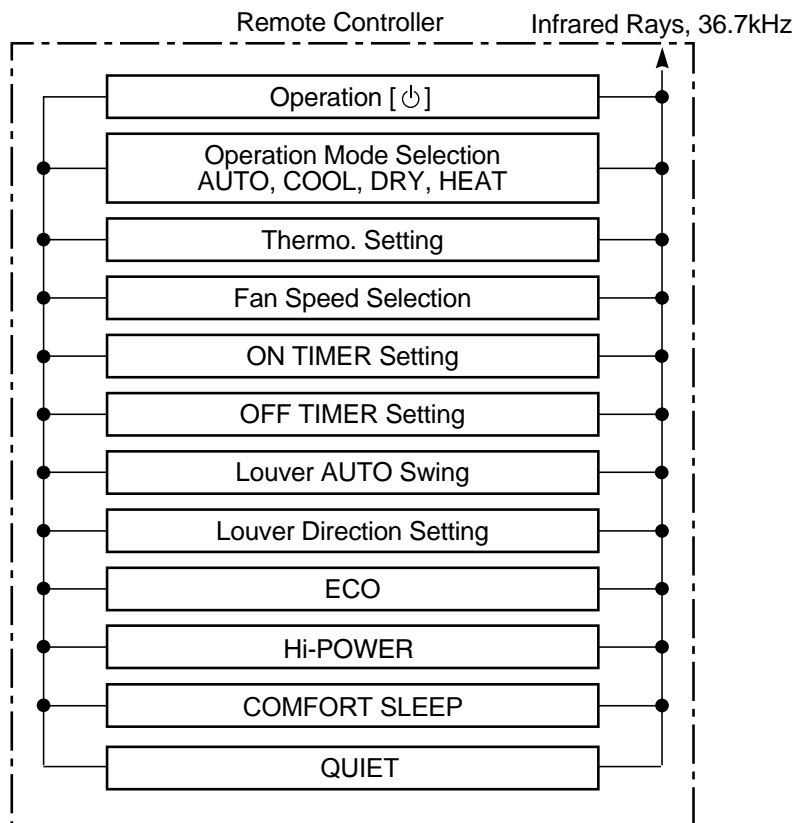

8-2. Outdoor Unit (Inverter Assembly)

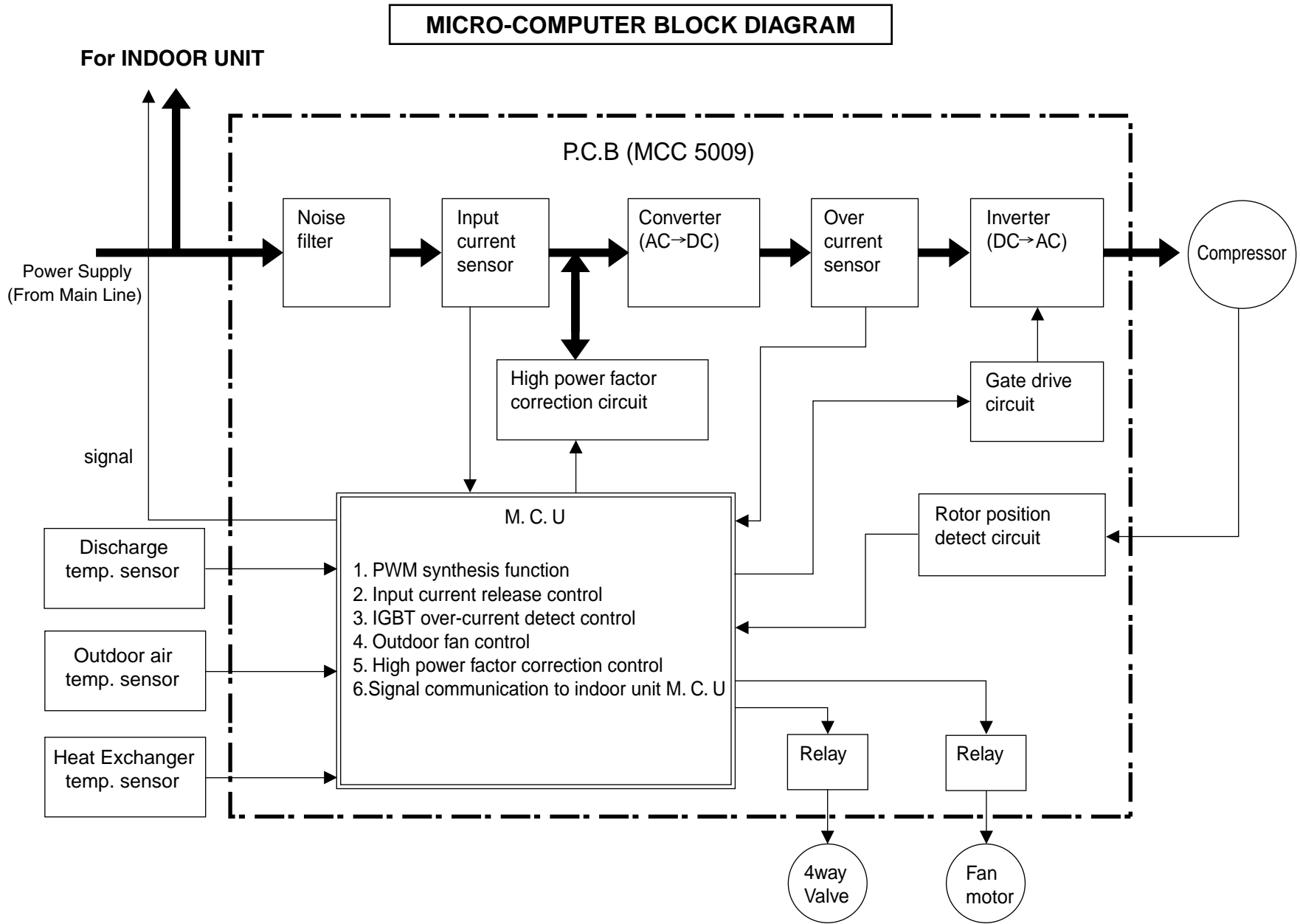

9. OPERATION DESCRIPTION

9-1. Outline of Air Conditioner Control

This air conditioner is a capacity-variable type air conditioner, which uses AC motor both the indoor fan motor and the outdoor fan motor. And the capacity-proportional control compressor which can change the motor speed in the range from 22 to 83 rps is mounted. The AC motor drive circuit is mounted to the indoor unit. The compressor and the inverter is mounted to the outdoor unit.

The entire air conditioner is mainly controlled by the indoor unit controller.

The indoor unit controller drives the indoor fan motor based upon command sent from the remote controller, and transfers the operation command to the outdoor unit controller.

The outdoor unit controller receives operation command from the indoor unit side, and controls the outdoor fan motor. Besides detecting revolution position of the compressor motor, the outdoor unit controller controls speed of the compressor motor by controlling output voltage of the inverter and switching timing of the supply power (current transfer timing) so that motors drive according to the operation command.

And then, the outdoor unit controller transfers reversely the operating status information of the outdoor unit to control the indoor unit controller.

As the compressor adopts four-pole brushless DC motor , the frequency of the supply power from in verter to compressor is two-times cycles of the actual number of revolution.

1. Role of indoor unit controller

The indoor unit controller judges the operation commands from the remote controller and assumes the following functions.

- Judgment of suction air temperature of the indoor heat exchanger by using the indoor temp. sensor. (TA sensor)
- Judgment of the indoor heat exchanger temperature by using heat exchanger sensor (TC sensor) (Prevent-freezing control, etc.)
- Louver motor control
- Indoor fan motor operation control
- LED (Light Emitting Diode) display control
- Transferring of operation command signal (Serial signal) to the outdoor unit
- Reception of information of operation status (Serial signal including outside temp. data) to the outdoor unit and judgment/display of error

2. Role of outdoor unit controller

Receiving the operation command signal (Serial signal) from the indoor unit controller, the outdoor unit performs its role.

- Compressor operation control
 - 4-way valve control
- } Operations followed to judgment of serial signal from indoor side

- Detection of inverter input current and current release operation
- Over-current detection and prevention operation to IGBT module (Compressor stop function)
- Compressor and outdoor fan stop function when serial signal is off (when the serial signal does not reach the board assembly of outdoor control by trouble of the signal system)
- Transferring of operation information (Serial signal) from outdoor unit controller to indoor unit controller
- Detection of outdoor temperature and operation revolution control
- Defrost control in heating operation (Temp. measurement by outdoor heat exchanger and control for 4-way valve and outdoor fan)

3. Contents of operation command signal (Serial signal) from indoor unit controller to outdoor unit controller

The following three types of signals are sent from the indoor unit controller.

- Operation mode set on the remote controller
- Compressor revolution command signal defined by indoor temperature and set temperature (Correction along with variation of room temperature and correction of indoor heat exchanger temperature are added.)
- Temperature of indoor heat exchanger
- For these signals ([Operation mode] and [Compressor revolution] indoor heat exchanger temperature), the outdoor unit controller monitors the input current to the inverter, and performs the followed operation within the range that current does not exceed the allowable value.

4. Contents of operation command signal (Serial signal) from outdoor unit controller to indoor unit controller

The following signals are sent from the outdoor unit controller.

- The current operation mode
 - The current compressor revolution
 - Outdoor temperature
 - Existence of protective circuit operation
- For transferring of these signals, the indoor unit controller monitors the contents of signals, and judges existence of trouble occurrence. Contents of judgment are described below.
- Whether distinction of the current operation status meets to the operation command signal
 - Whether protective circuit operates

When no signal is received from the outdoor unit controller, it is assumed as a trouble.

9-2. Operation Description

1. Basic operation	25
1. Operation control	25
2. Cooling/Heating operation	26
3. AUTO operation	26
4. DRY operation	26
2. Indoor fan motor control	27
3. Capacity control	29
4. Current release control	29
5. Release protective control by temperature of indoor heat exchanger	30
6. Defrost control (Only in heating operation)	31
7. Louver control	32
1) Louver position	32
2) Air direction adjustment	32
3) Swing	32
8. ECO operation	33
9. Temporary operation	34
10. Discharge temperature control	34
11. Self-Cleaning function	35
12. Remote-A or B selection	36
13. QUIET mode	37
14. COMFORT SLEEP mode	37
15. One-Touch Comfort	37
16. Hi-POWER Mode	38

9-3. Auto Restart Function

9-3-1. How to Set the Auto Restart Function	39
9-3-2. How to Cancel the Auto Restart Function	40
9-3-3. Power Failure During Timer Operation	40







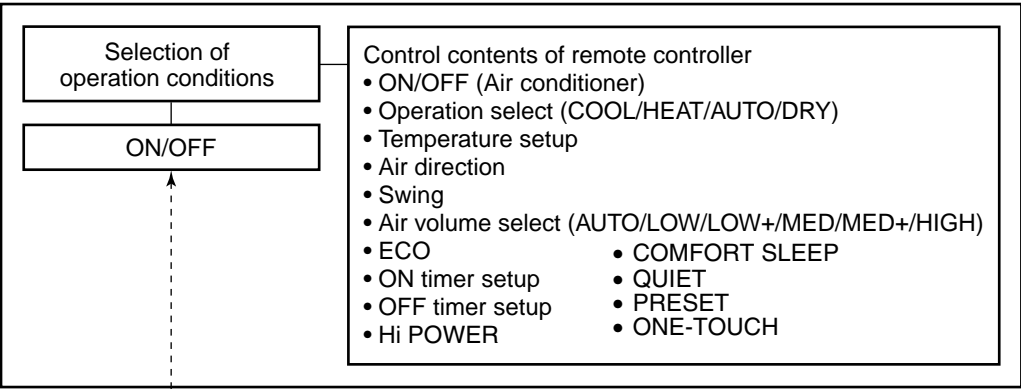
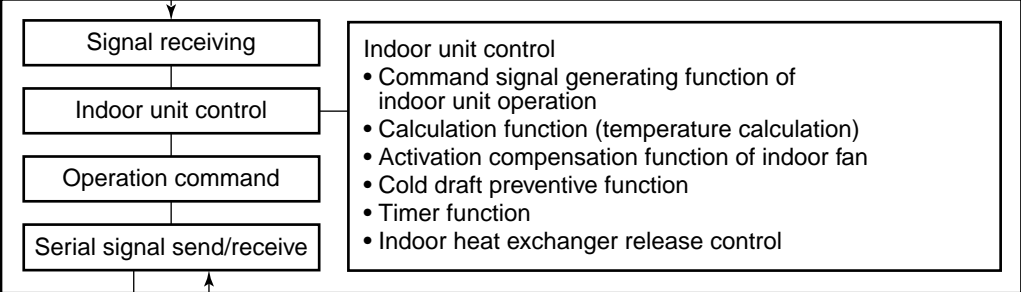
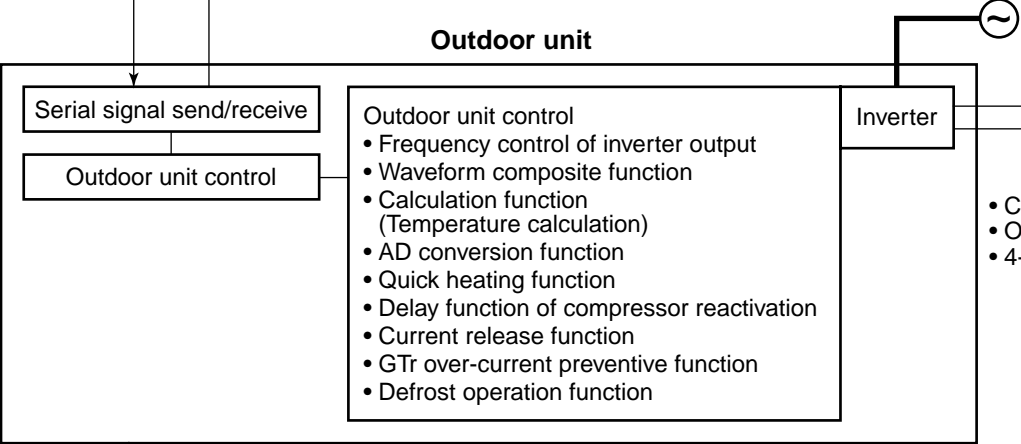

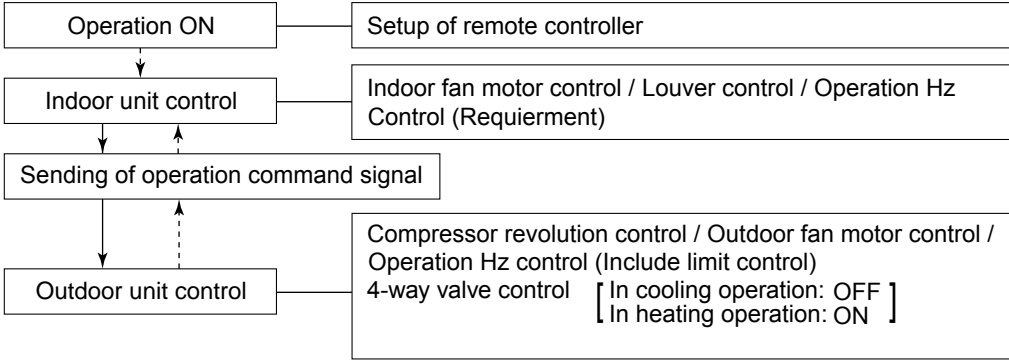
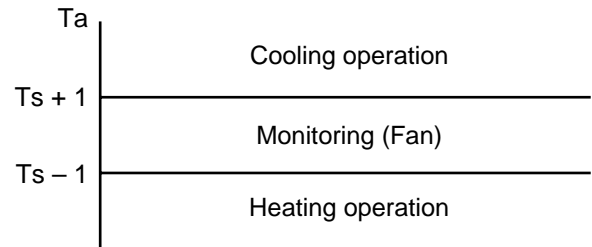
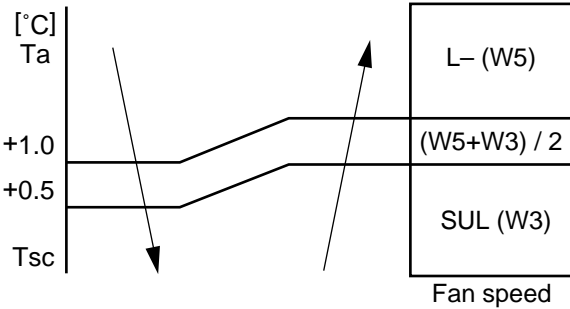

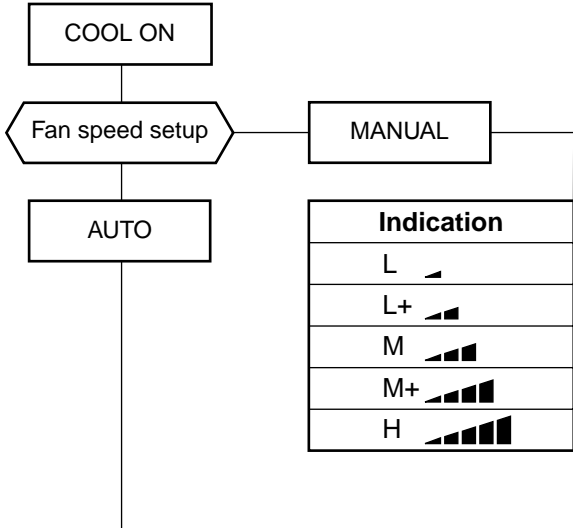





9-4. Remote Controller and Its Functions

9-4-1. Parts Name of Remote Controller	41
9-4-2. Operation of remote control	41
9-4-3. Name and Functions of Indications on Remote Controller	44

9-2. Operation Description

Item	Operation flow and applicable data, etc.	Description
<p>1. Basic operation</p>	<p>1. Operation control</p> <p>Receiving the user's operation condition setup, the operation statuses of indoor/outdoor units are controlled.</p> <ol style="list-style-type: none"> 1) The operation conditions are selected by the remote controller as shown in the below. 2) A signal is sent by ON button of the remote controller. 3) The signal is received by a sensor of the indoor unit and processed by the indoor controllers as shown in the below. 4) The indoor controller controls the indoor fan motor and louver motor. 5) The indoor controller sends the operation command to the outdoor controller, and sends/receives the control status with a serial signal. 6) The outdoor controller controls the operation as shown in the left, and also controls the compressor, outdoor fan motor and 4-way valve. <div style="text-align: center; margin-top: 20px;"> <p>Remote controller</p>  </div> <div style="text-align: center; margin-top: 20px;"> <p>Indoor unit</p>  </div> <div style="text-align: center; margin-top: 20px;"> <p>Outdoor unit</p>  </div>	

Item	Operation flow and applicable data, etc.	Description
<p>1. Basic operation</p>	<p>2. Cooling/Heating operation</p> <p>The operations are performed in the following parts by controls according to cooling/heating conditions.</p> <ol style="list-style-type: none"> 1) Receiving the operation ON signal of the remote controller, the cooling or heating operation signal starts being transferred from the indoor controller to the outdoor unit. 2) At the indoor unit side, the indoor fan is operated according to the contents of “2. Indoor fan motor control” and the louver according to the contents of “9. Louver control”, respectively. 3) The outdoor unit controls the outdoor fan motor, compressor and 4-way valve according to the operation signal sent from the indoor unit. 	
	<p>3. AUTO operation</p> <p>Selection of operation mode As shown in the following figure, the operation starts by selecting automatically the status of room temperature (Ta) when starting AUTO operation.</p> <p>*1. When reselecting the operation mode, the fan speed is controlled by the previous operation mode.</p> 	<ol style="list-style-type: none"> 1) Detects the room temperature (Ta) when the operation started. 2) Selects an operation mode from Ta in the left figure. 3) Fan operation continues until an operation mode is selected. 4) When AUTO operation has started within 2 hours after heating operation stopped and if the room temperature is 20°C or more, the fan operation is performed with "Super Ultra LOW" mode for 3 minutes. Then, select an operation mode. 5) If the status of compressor-OFF continues for 15 minutes the room temperature after selecting an operation mode (COOL/HEAT), reselect an operation mode.
	<p>4. DRY operation</p> <p>DRY operation is performed according to the difference between room temperature and the setup temperature as shown below.</p> <p>In DRY operation, fan speed is controlled in order to prevent lowering of the room temperature and to avoid air flow from blowing directly to persons.</p> 	<ol style="list-style-type: none"> 1) Detects the room temperature (Ta) when the DRY operation started. 2) Starts operation under conditions in the left figure according to the temperature difference between the room temperature and the setup temperature (Tsc). Setup temperature (Tsc) = Set temperature on remote controller (Ts) + (0.0 to 1.0) 3) When the room temperature is lower 1°C or less than the setup temperature, turn off the compressor.

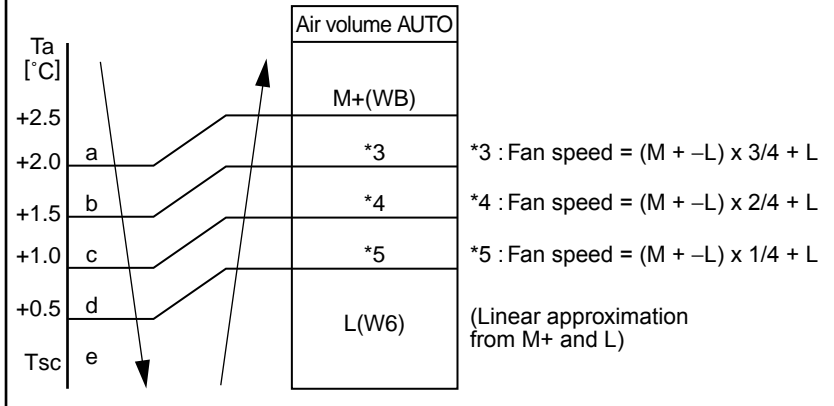

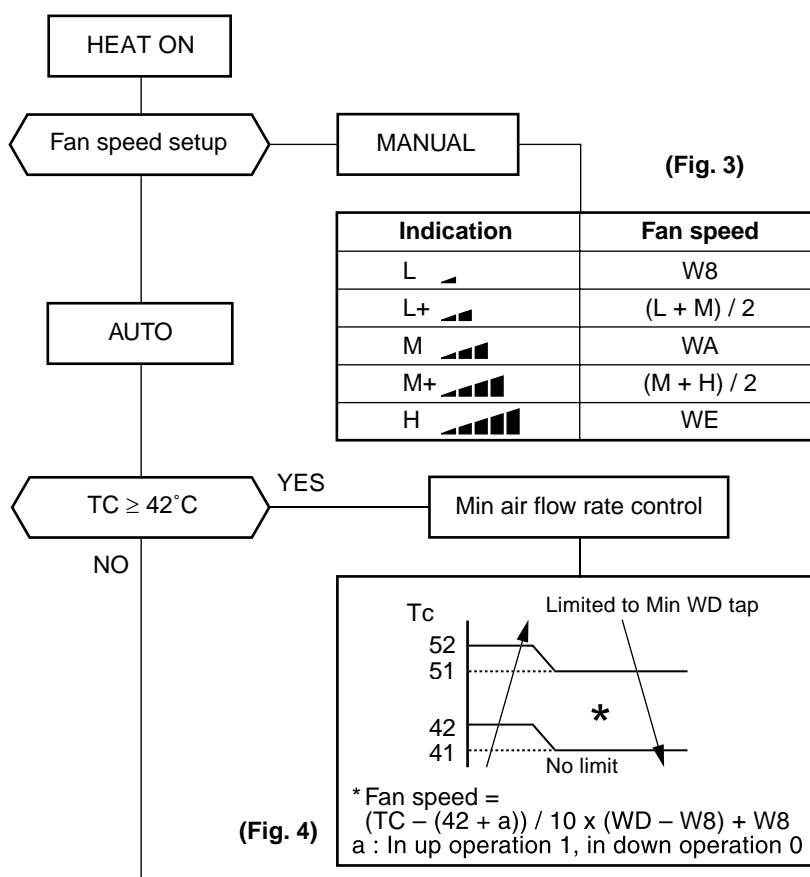
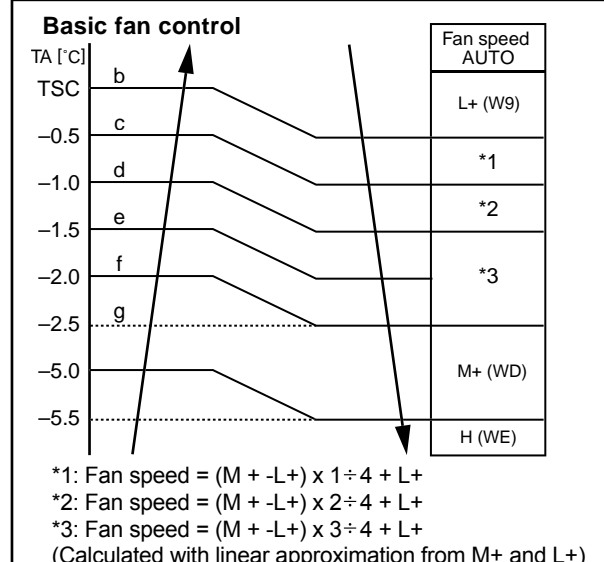
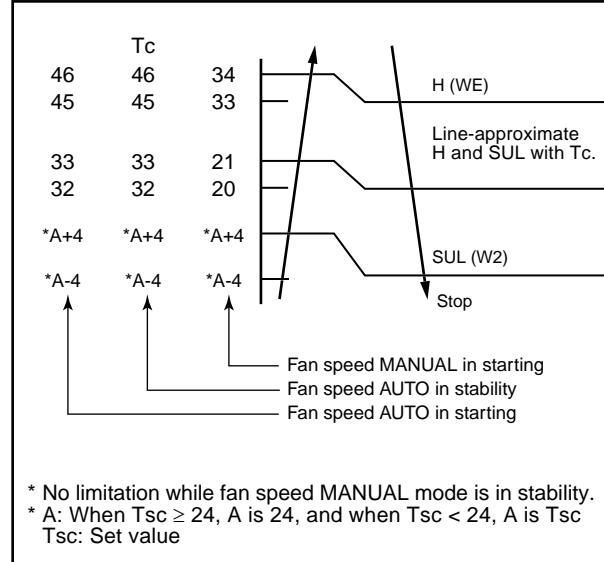

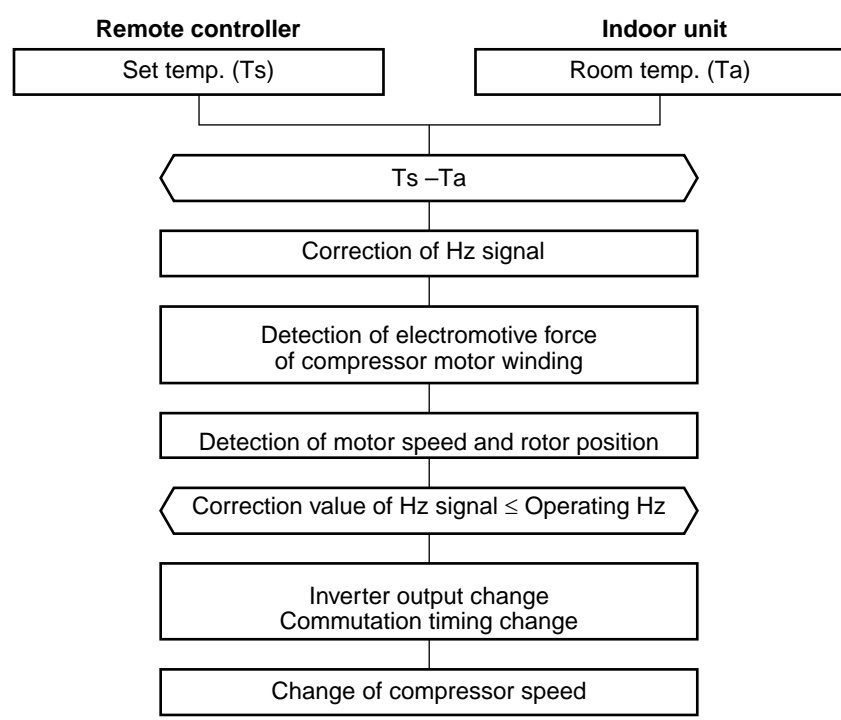
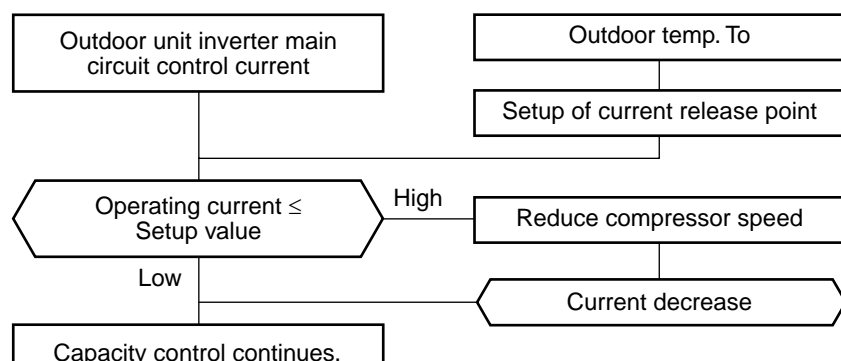



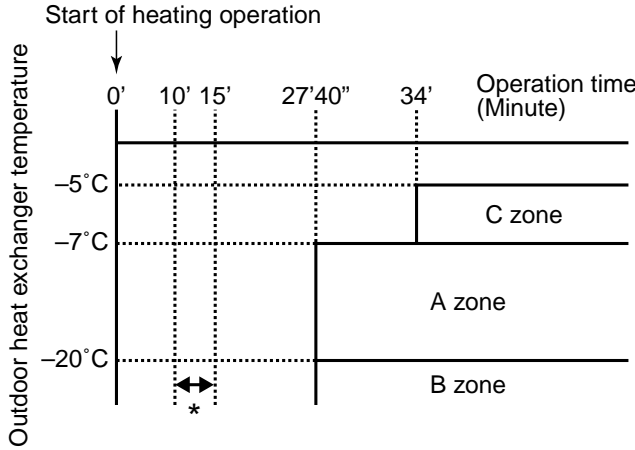

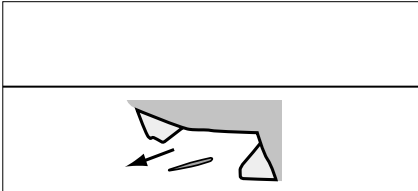
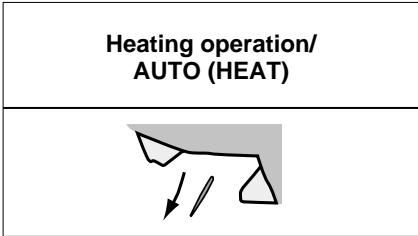





Item	Operation flow and applicable data, etc.	Description																																																																																																
<p>2. Indoor fan motor control</p>	<p><In cooling operation> (This operation controls the fan speed at indoor unit side.) The indoor fan (cross flow fan) is operated by the phase-control induction motor. The fan rotates in 5 stages in MANUAL mode, and in 5 stages in AUTO mode, respectively. (Table 1)</p>	<div style="border: 1px solid black; padding: 5px;"> <p>* Symbols</p> <p>UH : Ultra High H : High M+ : Medium+ M : Medium L+ : Low+ L : Low L- : Low- UL : Ultra Low SUL : Super Ultra Low</p> </div>																																																																																																
	<p>(Fig. 1)</p> <table border="1" data-bbox="470 638 1005 896"> <thead> <tr> <th>Indication</th> <th>Fan speed</th> </tr> </thead> <tbody> <tr> <td>L </td> <td>W6</td> </tr> <tr> <td>L+ </td> <td>(L + M) / 2</td> </tr> <tr> <td>M </td> <td>W9</td> </tr> <tr> <td>M+ </td> <td>(M + H) / 2</td> </tr> <tr> <td>H </td> <td>WC</td> </tr> </tbody> </table> <p>(Fig. 2)</p>	Indication	Fan speed	L 	W6	L+ 	(L + M) / 2	M 	W9	M+ 	(M + H) / 2	H 	WC	<p>* The fan speed broadly varies due to position of the louver, etc. The described value indicates one under condition of inclining downward blowing.</p> <p>1) When setting the fan speed to L, L+, M, M+ or H on the remote controller, the operation is performed with the constant speed shown in Fig. 1.</p> <p>2) When setting the fan speed to AUTO on the remote controller, revolution of the fan motor is controlled to the fan speed level shown in Fig. 2 and Table 1 according to the setup temperature, room temperature, and heat exchanger temperature.</p>																																																																																				
Indication	Fan speed																																																																																																	
L 	W6																																																																																																	
L+ 	(L + M) / 2																																																																																																	
M 	W9																																																																																																	
M+ 	(M + H) / 2																																																																																																	
H 	WC																																																																																																	
	<table border="1" data-bbox="454 996 1005 1388"> <thead> <tr> <th>Air volume AUTO</th> <th>Fan speed</th> </tr> </thead> <tbody> <tr> <td>M+(WB)</td> <td>*3</td> </tr> <tr> <td></td> <td>*4</td> </tr> <tr> <td></td> <td>*5</td> </tr> <tr> <td>L(W6)</td> <td>(Linear approximation from M+ and L)</td> </tr> </tbody> </table> <p>*3 : Fan speed = (M + -L) x 3/4 + L *4 : Fan speed = (M + -L) x 2/4 + L *5 : Fan speed = (M + -L) x 1/4 + L</p>	Air volume AUTO	Fan speed	M+(WB)	*3		*4		*5	L(W6)	(Linear approximation from M+ and L)																																																																																							
Air volume AUTO	Fan speed																																																																																																	
M+(WB)	*3																																																																																																	
	*4																																																																																																	
	*5																																																																																																	
L(W6)	(Linear approximation from M+ and L)																																																																																																	
<p>(Table 1) Indoor fan and air flow rate</p>																																																																																																		
<table border="1" data-bbox="263 1489 933 2060"> <thead> <tr> <th>Fan speed level</th> <th>COOL</th> <th>HEAT</th> <th>DRY</th> <th>Fan speed (rpm)</th> <th>Air flow rate (m³/h)</th> </tr> </thead> <tbody> <tr><td>WF</td><td></td><td>UH</td><td></td><td>1350</td><td>607</td></tr> <tr><td>WE</td><td></td><td>H</td><td></td><td>1300</td><td>576</td></tr> <tr><td>WD</td><td>UH</td><td>M+</td><td>UH</td><td>1250</td><td>554</td></tr> <tr><td>WC</td><td>H</td><td></td><td>H</td><td>1200</td><td>522</td></tr> <tr><td>WB</td><td>M+</td><td>M</td><td>M+</td><td>1120</td><td>486</td></tr> <tr><td>WA</td><td></td><td></td><td>M</td><td>1100</td><td>468</td></tr> <tr><td>W9</td><td>M</td><td>L+</td><td></td><td>1040</td><td>444</td></tr> <tr><td>W8</td><td></td><td>L</td><td></td><td>960</td><td>402</td></tr> <tr><td>W7</td><td>L+</td><td>L-</td><td>L+</td><td>910</td><td>376</td></tr> <tr><td>W6</td><td>L</td><td></td><td>L</td><td>880</td><td>360</td></tr> <tr><td>W5</td><td>L-</td><td>UL</td><td>L-</td><td>830</td><td>334</td></tr> <tr><td>W4</td><td>UL</td><td></td><td>UL</td><td>800</td><td>318</td></tr> <tr><td>W3</td><td>SUL</td><td></td><td>SUL</td><td>700</td><td>266</td></tr> <tr><td>W2</td><td></td><td>SUL</td><td></td><td>650</td><td>239</td></tr> <tr><td>W1</td><td></td><td></td><td></td><td>600</td><td>213</td></tr> </tbody> </table>	Fan speed level	COOL	HEAT	DRY	Fan speed (rpm)	Air flow rate (m ³ /h)	WF		UH		1350	607	WE		H		1300	576	WD	UH	M+	UH	1250	554	WC	H		H	1200	522	WB	M+	M	M+	1120	486	WA			M	1100	468	W9	M	L+		1040	444	W8		L		960	402	W7	L+	L-	L+	910	376	W6	L		L	880	360	W5	L-	UL	L-	830	334	W4	UL		UL	800	318	W3	SUL		SUL	700	266	W2		SUL		650	239	W1				600	213		
Fan speed level	COOL	HEAT	DRY	Fan speed (rpm)	Air flow rate (m ³ /h)																																																																																													
WF		UH		1350	607																																																																																													
WE		H		1300	576																																																																																													
WD	UH	M+	UH	1250	554																																																																																													
WC	H		H	1200	522																																																																																													
WB	M+	M	M+	1120	486																																																																																													
WA			M	1100	468																																																																																													
W9	M	L+		1040	444																																																																																													
W8		L		960	402																																																																																													
W7	L+	L-	L+	910	376																																																																																													
W6	L		L	880	360																																																																																													
W5	L-	UL	L-	830	334																																																																																													
W4	UL		UL	800	318																																																																																													
W3	SUL		SUL	700	266																																																																																													
W2		SUL		650	239																																																																																													
W1				600	213																																																																																													

Item	Operation flow and applicable data, etc.	Description												
<p>2. Indoor fan motor control</p> 	<p><In heating operation></p> <p>(Fig. 3)</p> <table border="1" data-bbox="494 492 973 716"> <thead> <tr> <th>Indication</th> <th>Fan speed</th> </tr> </thead> <tbody> <tr> <td>L </td> <td>W8</td> </tr> <tr> <td>L+ </td> <td>(L + M) / 2</td> </tr> <tr> <td>M </td> <td>WA</td> </tr> <tr> <td>M+ </td> <td>(M + H) / 2</td> </tr> <tr> <td>H </td> <td>WE</td> </tr> </tbody> </table> <p>(Fig. 4)</p> <p>* Fan speed = $(TC - (42 + a)) / 10 \times (WD - W8) + W8$ a : In up operation 1, in down operation 0</p>	Indication	Fan speed	L	W8	L+	(L + M) / 2	M	WA	M+	(M + H) / 2	H	WE	<ol style="list-style-type: none"> 1) When setting the fan speed to L, L+, M, M+ or H on the remote controller, the operation is performed with the constant speed shown in Fig. 3 and Table 1. 2) When setting the fan speed to AUTO on the remote controller, revolution of the fan motor is controlled to the fan speed level shown in Fig. 5 according to the set temperature and room temperature. 3) Min air flow rate is controlled by temperature of the indoor heat exchanger (Tc) as shown in Fig. 4. 4) Cold draft prevention, the fan speed is controlled by temperature of the indoor heat exchanger (Tc) as shown in Fig. 6. 5) In order to prevent cold draft when compressor stop during heating operation. Then louver will move to upper position and fan speed will reduce or off. <p>Cold draft preventive control</p>
Indication	Fan speed													
L	W8													
L+	(L + M) / 2													
M	WA													
M+	(M + H) / 2													
H	WE													
<p>Basic fan control</p>  <p>*1: Fan speed = $(M + -L+) \times 1 \div 4 + L+$ *2: Fan speed = $(M + -L+) \times 2 \div 4 + L+$ *3: Fan speed = $(M + -L+) \times 3 \div 4 + L+$ (Calculated with linear approximation from M+ and L+)</p>	<p>(Fig. 5)</p>	 <p>* No limitation while fan speed MANUAL mode is in stability. *A: When Tsc ≥ 24, A is 24, and when Tsc < 24, A is Tsc Tsc: Set value</p>	<p>(Fig. 6)</p>											
<p>[In starting and in stability]</p>	<table border="1" data-bbox="159 1859 1420 2060"> <thead> <tr> <th></th> <th>In starting</th> <th>In stability</th> </tr> </thead> <tbody> <tr> <td>FAN AUTO</td> <td> <ul style="list-style-type: none"> • Until 12 minutes passed after operation start • When 12 to 25 minutes passed after operation start and room temp. is 3°C or lower than set temp. </td> <td> <ul style="list-style-type: none"> • When 12 to 25 minutes passed after operation start and room temp. is higher than (set temp. -3°C) • When 25 minutes or more passed after operation start </td> </tr> <tr> <td>FAN Manual</td> <td> <ul style="list-style-type: none"> • Room temp. < Set temp. -4°C </td> <td> <ul style="list-style-type: none"> • Room temp. ≥ Set temp. -3.5°C </td> </tr> </tbody> </table>		In starting	In stability	FAN AUTO	<ul style="list-style-type: none"> • Until 12 minutes passed after operation start • When 12 to 25 minutes passed after operation start and room temp. is 3°C or lower than set temp. 	<ul style="list-style-type: none"> • When 12 to 25 minutes passed after operation start and room temp. is higher than (set temp. -3°C) • When 25 minutes or more passed after operation start 	FAN Manual	<ul style="list-style-type: none"> • Room temp. < Set temp. -4°C 	<ul style="list-style-type: none"> • Room temp. ≥ Set temp. -3.5°C 				
	In starting	In stability												
FAN AUTO	<ul style="list-style-type: none"> • Until 12 minutes passed after operation start • When 12 to 25 minutes passed after operation start and room temp. is 3°C or lower than set temp. 	<ul style="list-style-type: none"> • When 12 to 25 minutes passed after operation start and room temp. is higher than (set temp. -3°C) • When 25 minutes or more passed after operation start 												
FAN Manual	<ul style="list-style-type: none"> • Room temp. < Set temp. -4°C 	<ul style="list-style-type: none"> • Room temp. ≥ Set temp. -3.5°C 												

Item	Operation flow and applicable data, etc.	Description																
<p>3. Capacity control</p>	<p>The cooling or heating capacity depending on the load is adjusted.</p> <p>According to difference between the setup value of temperature and the room temperature, the capacity is adjusted by the compressor revolution.</p> 	<ol style="list-style-type: none"> 1) The difference between set temperature on remote controller (Ts) and room temperature (Ta) is calculated. 2) According to the temperature difference, the correction value of Hz signal which determines the compressor speed is set up. 3) The rotating position and speed of the motor are detected by the electromotive force occurred on the motor winding with operation of the compressor. 4) According to the difference resulted from comparison of the correction value of Hz signal with the present operation Hz, the inverter output and the commutation timing are varied. 5) Change the compressor motor speed by outputting power to the compressor. <p>* The contents of control operation are same in cooling operation and heating operation</p>																
<p>4. Current release control</p>	<p>This function prevents troubles on the electronic parts of the compressor driving inverter.</p> <p>This function also controls drive circuit of the compressor speed so that electric power of the compressor drive circuit does not exceed the specified value.</p>  <table border="1" data-bbox="175 1747 877 2038"> <thead> <tr> <th>Outdoor temp.</th> <th>Cooling current release value</th> <th>Heating current release value</th> </tr> </thead> <tbody> <tr> <td>45°C</td> <td>3.60A</td> <td rowspan="3">7.72A</td> </tr> <tr> <td>40°C</td> <td>5.17A</td> </tr> <tr> <td>16°C</td> <td>5.17A</td> </tr> <tr> <td>11°C</td> <td>15.5°C</td> <td>9.26A</td> </tr> <tr> <td></td> <td>10.5°C</td> <td>10.80A</td> </tr> </tbody> </table>	Outdoor temp.	Cooling current release value	Heating current release value	45°C	3.60A	7.72A	40°C	5.17A	16°C	5.17A	11°C	15.5°C	9.26A		10.5°C	10.80A	<ol style="list-style-type: none"> 1) The input current of the outdoor unit is detected in the inverter section of the outdoor unit. 2) According to the detected outdoor temperature, the specified value of the current is selected. 3) Whether the current value exceeds the specified value or not is judged. 4) If the current value exceeds the specified value, this function reduces the compressor speed and controls speed up to the closest one commanded from the indoor unit within the range which does not exceed the specified value.
Outdoor temp.	Cooling current release value	Heating current release value																
45°C	3.60A	7.72A																
40°C	5.17A																	
16°C	5.17A																	
11°C	15.5°C	9.26A																
	10.5°C	10.80A																

Item	Operation flow and applicable data, etc.	Description
<p>5. Release protective control by temperature of indoor heat exchanger</p>	<p><In cooling/dry operation> (Prevent-freezing control for indoor heat exchanger) In cooling/dry operation, the sensor of indoor heat exchanger detects evaporation temperature and controls the compressor speed so that temperature of the heat exchanger does not exceed the specified value.</p>	<ol style="list-style-type: none"> 1) When temperature of the indoor heat exchanger drops below 5°C, the compressor speed is reduced. (P zone) 2) When temperature of the indoor heat exchanger rises in the range from 6°C to under 7°C, the compressor speed is kept. (Q zone) 3) When temperature of the indoor heat exchanger rises to 7°C or higher, the capacity control operation returns to the usual control in cooling operation. (R zone)
	<p><In heating operation> (Prevent-overpressure control for refrigerating cycle) In heating operation, the sensor of indoor heat exchanger detects condensation temperature and controls the compressor speed so that temperature of the heat exchanger does not exceed the specified value.</p>	<ol style="list-style-type: none"> 1) When temperature of the indoor heat exchanger rises in the range from 50°C to 55°C, the compressor speed is kept. (Q zone) When temperature of the indoor heat exchanger drops in the range from 46°C to under 55°C, the compressor speed is kept. (Q zone) 2) When temperature of the indoor heat exchanger rises to 55°C or higher, the compressor speed is reduced. (P zone) 3) When temperature of the indoor heat exchanger does not rise to 50°C, or when it drops below to 46°C, the capacity control operation returns to the usual control in heating operation. (R zone)

Item	Operation flow and applicable data, etc.	Description								
<p>6. Defrost control (Only in heating operation)</p>	<p>(This function removes frost adhered to the outdoor heat exchanger.)</p> <p>The temperature sensor of the outdoor heat exchanger (Te sensor) judges the frosting status of the outdoor heat exchanger and the defrost operation is performed with 4-way valve reverse defrost system.</p>  <p style="text-align: center;">* The minimum value of Te sensor 10 to 15 minutes after start of operation is stored in memory as Te0.</p> <p style="text-align: center;">Table 1</p> <table border="1" data-bbox="167 1041 933 1243"> <thead> <tr> <th>Zone</th> <th>Condition</th> </tr> </thead> <tbody> <tr> <td>A zone</td> <td>When $Te_0 - TE \geq 2.5$ continued for 2 minutes in A zone, defrost operation starts.</td> </tr> <tr> <td>B zone</td> <td>When the operation continued for 2 minutes in B zone, defrost operation starts.</td> </tr> <tr> <td>C zone</td> <td>When $Te_0 - TE \geq 3$ continued for 2 minutes in C zone, defrost operation starts.</td> </tr> </tbody> </table>	Zone	Condition	A zone	When $Te_0 - TE \geq 2.5$ continued for 2 minutes in A zone, defrost operation starts.	B zone	When the operation continued for 2 minutes in B zone, defrost operation starts.	C zone	When $Te_0 - TE \geq 3$ continued for 2 minutes in C zone, defrost operation starts.	<p>The necessity of defrost operation is detected by the outdoor heat exchanger temperature. The conditions to detect the necessity of defrost operation differ in A, B, or C zone each. (Table 1)</p> <p><Defrost operation></p> <ul style="list-style-type: none"> Defrost operation in A to C zones <ol style="list-style-type: none"> 1) Stop operation of the compressor for 20 seconds. 2) Invert (OFF) 4-way valve 10 seconds after stop of the compressor. 3) The outdoor fan stops at the same time when the compressor stops. 4) When temperature of the indoor heat exchanger becomes 38°C or lower, stop the indoor fan. <p><Finish of defrost operation></p> <ul style="list-style-type: none"> Returning conditions from defrost operation to heating operation <ol style="list-style-type: none"> 1) Temperature of outdoor heat exchanger rises to +8°C or higher. 2) Temperature of outdoor heat exchanger is kept at +5°C or higher for 80 seconds. 3) Defrost operation continues for 15 minutes. <p><Returning from defrost operation></p> <ol style="list-style-type: none"> 1) Stop operation of the compressor for approx. 50 seconds. 2) Invert (ON) 4-way valve approx. 40 seconds after stop of the compressor. 3) The outdoor fan starts rotating at the same time when the compressor starts.
Zone	Condition									
A zone	When $Te_0 - TE \geq 2.5$ continued for 2 minutes in A zone, defrost operation starts.									
B zone	When the operation continued for 2 minutes in B zone, defrost operation starts.									
C zone	When $Te_0 - TE \geq 3$ continued for 2 minutes in C zone, defrost operation starts.									

Item	Operation flow and applicable data, etc.	Description										
<p>7. Louver control</p> <p>1) Louver position</p> <p>2) Air direction adjustment</p> <p>3) Swing</p>	<p>This function controls the air direction of the indoor unit.</p> <ul style="list-style-type: none"> The position is automatically controlled according to the operation mode (COOL/HEAT). The set louver position is stored in memory by the microcomputer, and the louver returns to the stored position when the next operation is performed. (Cooling/Heating memory position) <p>The angle of the louver is indicated as the louver closes fully is 0°.</p> <p>1) Louver position in cooling operation</p> <div data-bbox="438 544 858 801" style="border: 1px solid black; padding: 5px;">  <p>Initial setting of "Cooling storage position" Louver : Directs downward (48°)</p> </div> <p>2) Louver position in heating operation</p> <div data-bbox="443 916 863 1223" style="border: 1px solid black; padding: 5px;"> <p style="text-align: center;">Heating operation/ AUTO (HEAT)</p>  <p>Initial setting of "Heating storage position" Louver : Directs downward (115.7°)</p> </div> <div data-bbox="177 1312 1120 1585" style="border: 1px solid black; padding: 5px; margin-top: 20px;"> <p style="text-align: center;">Air direction</p> <table border="1" style="width: 100%; text-align: center;"> <tr> <td>Horizontal blowing</td> <td>Inclined blowing</td> <td>Blowing downward</td> <td>Inclined blowing</td> <td>Horizontal blowing</td> </tr> <tr> <td></td> <td></td> <td></td> <td></td> <td></td> </tr> </table> </div>	Horizontal blowing	Inclined blowing	Blowing downward	Inclined blowing	Horizontal blowing						<ul style="list-style-type: none"> The louver position can be arbitrarily set up by pressing [FIX] button. Swing When pressing [SWING] button during operation, the louver starts swinging.
Horizontal blowing	Inclined blowing	Blowing downward	Inclined blowing	Horizontal blowing								
												

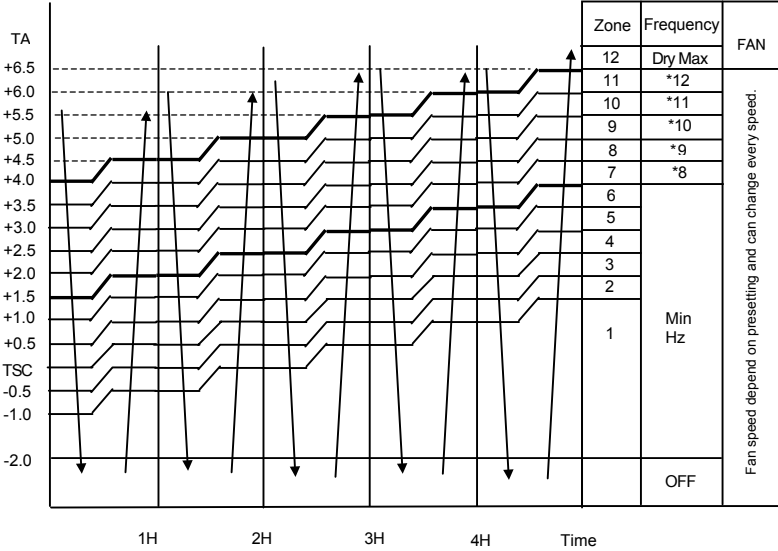
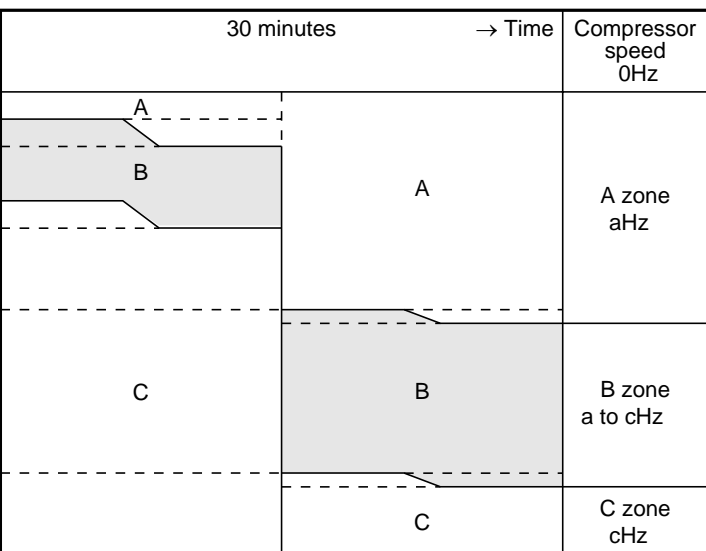
Item	Operation flow and applicable data, etc.	Description																																																														
<p>8. ECO operation</p>	<p>When pressing [ECO] button on the remote controller, a Economic operation is performed.</p> <p><Cooling operation></p> <p>This function operates the air conditioner with the difference between the set and the room temperature as shown in the following figure.</p>  <table border="1" data-bbox="805 459 1005 963"> <thead> <tr> <th>Zone</th> <th>Frequency</th> <th>FAN</th> </tr> </thead> <tbody> <tr><td>12</td><td>Dry Max</td><td></td></tr> <tr><td>11</td><td>*12</td><td></td></tr> <tr><td>10</td><td>*11</td><td></td></tr> <tr><td>9</td><td>*10</td><td></td></tr> <tr><td>8</td><td>*9</td><td></td></tr> <tr><td>7</td><td>*8</td><td></td></tr> <tr><td>6</td><td></td><td></td></tr> <tr><td>5</td><td></td><td></td></tr> <tr><td>4</td><td></td><td></td></tr> <tr><td>3</td><td></td><td></td></tr> <tr><td>2</td><td></td><td></td></tr> <tr><td>1</td><td>Min Hz</td><td></td></tr> <tr><td></td><td></td><td>OFF</td></tr> </tbody> </table> <p style="text-align: right; font-size: small;">Fan speed depend on presetting and can change every speed.</p> <p>* 12 (DRY max - COOL min) /6 x 5 + COOL min * 11 (DRY max - COOL min) /6 x 4 + COOL min * 10 (DRY max - COOL min) /6 x 3 + COOL min * 9 (DRY max - COOL min) /6 x 2 + COOL min * 8 (DRY max - COOL min) /6 x 1 + COOL min</p> <table border="1" data-bbox="702 1198 997 1332"> <thead> <tr> <th colspan="2">Hz</th> </tr> </thead> <tbody> <tr> <td>Cool min</td> <td>22</td> </tr> <tr> <td>DRY max</td> <td>32</td> </tr> </tbody> </table> <p><Heating operation></p>  <table border="1" data-bbox="861 1377 1005 1926"> <thead> <tr> <th>Compressor speed</th> <th>0Hz</th> </tr> </thead> <tbody> <tr> <td>A zone</td> <td>aHz</td> </tr> <tr> <td>B zone</td> <td>a to cHz</td> </tr> <tr> <td>C zone</td> <td>cHz</td> </tr> </tbody> </table> <table border="1" data-bbox="750 1937 1005 2072"> <thead> <tr> <th colspan="2">Hz</th> </tr> </thead> <tbody> <tr> <td>a</td> <td>22</td> </tr> <tr> <td>b</td> <td>52</td> </tr> </tbody> </table>	Zone	Frequency	FAN	12	Dry Max		11	*12		10	*11		9	*10		8	*9		7	*8		6			5			4			3			2			1	Min Hz				OFF	Hz		Cool min	22	DRY max	32	Compressor speed	0Hz	A zone	aHz	B zone	a to cHz	C zone	cHz	Hz		a	22	b	52	<p><Cooling operation></p> <ol style="list-style-type: none"> 1) The control target temperature increase 0.5°C per hour up to 2°C starting from the set temperature when ECONO has been received. 2) The indoor fan speed is depend on presetting and can change every speed after setting ECO operation. 3) The compressor speed is controlled as shown in the left figure. <p><Heating operation></p> <ol style="list-style-type: none"> 1) Setting the compressor speed to Max. aHz, the temperature zone in which the operation can be performed with Max. cHz is gradually widened after 30 minutes passed when starting ECO operation. 2) The indoor fan speed is depend on presetting and can change every speed after setting ECO operation.
Zone	Frequency	FAN																																																														
12	Dry Max																																																															
11	*12																																																															
10	*11																																																															
9	*10																																																															
8	*9																																																															
7	*8																																																															
6																																																																
5																																																																
4																																																																
3																																																																
2																																																																
1	Min Hz																																																															
		OFF																																																														
Hz																																																																
Cool min	22																																																															
DRY max	32																																																															
Compressor speed	0Hz																																																															
A zone	aHz																																																															
B zone	a to cHz																																																															
C zone	cHz																																																															
Hz																																																																
a	22																																																															
b	52																																																															

Item	Operation flow and applicable data, etc.	Description													
<p>9. Temporary operation</p>	<p>Pressing [RESET] button starts the temporary operation of [AUTO] operation. When keeping [RESET] button pressed for 10 seconds or more, the temporary [COOL] operation is performed.</p> <pre> graph TD A[Filter lamp ON] -- YES --> B[Press RESET button.] A -- NO --> C{Did you press [RESET] button for 3 seconds or more?} C -- NO --> D[Temporary [AUTO] operation] C -- YES --> E{Did you press [RESET] button for 10 seconds or more?} E -- YES --> F[Temporary [COOL] Operation] E -- NO --> G[Switch to [AUTO RESTART] control.] F --> A </pre>	<ol style="list-style-type: none"> 1) When pressing [RESET] button, the temporary [AUTO] operation starts. 2) When keeping [RESET] button pressed for 3 seconds or more, Pi, Pi, Pi sound is heard and [AUTO RESTART] control is changed. 3) When keeping [RESET] button pressed for 10 seconds or more, "Pi" sound is heard and the temporary [COOL] operation starts. 4) If the filter lamp goes on, press [RESET] button to go off the filter lamp, and then press [RESET] button again. 5) To stop the temporary operation, press the button again. 													
<p>10. Discharge temperature control</p> <table border="1" data-bbox="167 907 927 1243"> <thead> <tr> <th data-bbox="167 907 320 952">Td value</th> <th data-bbox="320 907 927 952">Control operation</th> </tr> </thead> <tbody> <tr> <td data-bbox="167 952 320 996">117°C</td> <td data-bbox="320 952 927 996">Judges as an error and stops the compressor.</td> </tr> <tr> <td data-bbox="167 996 320 1041">112°C</td> <td data-bbox="320 996 927 1041">Reduce the compressor speed.</td> </tr> <tr> <td data-bbox="167 1041 320 1086">108°C</td> <td data-bbox="320 1041 927 1086">Reduce slowly compressor speed.</td> </tr> <tr> <td data-bbox="167 1086 320 1131">105°C</td> <td data-bbox="320 1086 927 1131">Keeps the compressor speed.</td> </tr> <tr> <td data-bbox="167 1131 320 1198">98°C</td> <td data-bbox="320 1131 927 1198">If the operation is performed with lower speed than one commanded by the serial signal, speed is slowly raised up to the commanded speed.</td> </tr> <tr> <td data-bbox="167 1198 320 1243">98°C</td> <td data-bbox="320 1198 927 1243">Operates with speed commanded by the serial signal.</td> </tr> </tbody> </table>	Td value	Control operation	117°C	Judges as an error and stops the compressor.	112°C	Reduce the compressor speed.	108°C	Reduce slowly compressor speed.	105°C	Keeps the compressor speed.	98°C	If the operation is performed with lower speed than one commanded by the serial signal, speed is slowly raised up to the commanded speed.	98°C	Operates with speed commanded by the serial signal.	<ol style="list-style-type: none"> 1. Purpose This function detects error on the refrigerating cycle or error on the compressor, and performs protective control. 2. Operation <ul style="list-style-type: none"> • Control of the compressor speed The speed control is performed as described in the left table based upon the discharge temperature.
Td value	Control operation														
117°C	Judges as an error and stops the compressor.														
112°C	Reduce the compressor speed.														
108°C	Reduce slowly compressor speed.														
105°C	Keeps the compressor speed.														
98°C	If the operation is performed with lower speed than one commanded by the serial signal, speed is slowly raised up to the commanded speed.														
98°C	Operates with speed commanded by the serial signal.														

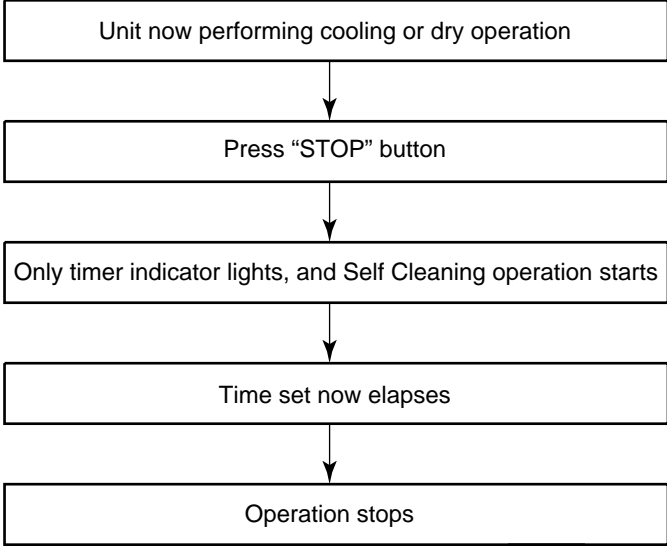
Item	Operation flow and applicable data, etc.	Description													
<p>11. Self-Cleaning function</p>	 <pre> graph TD A[Unit now performing cooling or dry operation] --> B[Press "STOP" button] B --> C[Only timer indicator lights, and Self Cleaning operation starts] C --> D[Time set now elapses] D --> E[Operation stops] </pre> <ul style="list-style-type: none"> • During Self-Cleaning operations: The louver opens slightly. The indoor fan operates continuously at a speed of 500 rpm. <p>Self-Cleaning operation times</p> <table border="1" data-bbox="395 1227 1262 1576"> <thead> <tr> <th></th> <th>Operation time</th> <th>Self-Cleaning operation time</th> </tr> </thead> <tbody> <tr> <td rowspan="2">Cooling: Auto (cooling) Dry</td> <td>Up to 10 minutes</td> <td>No Self-Cleaning operation performed (0 minutes)</td> </tr> <tr> <td>10 minutes or longer</td> <td>30 mins.</td> </tr> <tr> <td>Heating: Auto (heating)</td> <td colspan="2" rowspan="3">No Self-Cleaning operation performed</td> </tr> <tr> <td>Auto (fan only)</td> </tr> <tr> <td>Shutdown</td> </tr> </tbody> </table> <ul style="list-style-type: none"> • To stop an ongoing Self-Cleaning operation at any time Press the start/stop button on the remote controller twice during the Self-Cleaning operation. (After pressing the button for the first time, press it for the second time without delay (within 10 minutes).) 		Operation time	Self-Cleaning operation time	Cooling: Auto (cooling) Dry	Up to 10 minutes	No Self-Cleaning operation performed (0 minutes)	10 minutes or longer	30 mins.	Heating: Auto (heating)	No Self-Cleaning operation performed		Auto (fan only)	Shutdown	<p>1. Purpose</p> <p>The Self-Cleaning operation is to minimize the growth of mold, bacteria etc. by running the fan and drying so as to keep the inside of the air conditioner clean.</p> <p>Self-Cleaning operation</p> <p>When the cooling or dry operation shuts down, the unit automatically starts the Self-Cleaning operation which is then performed for the specified period based on duration of the operation which was performed prior to the shutdown, after which the Self-Cleaning operation stops. (The Self-Cleaning operation is not performed after a heating operation.)</p> <p>2. Operation</p> <ol style="list-style-type: none"> 1) When the stop signal from the remote controller or timer-off function is received, only the timer indicator light. 2) The period of the Self-Cleaning operation is determined by the duration of the operation performed prior to the reception of the stop code. 3) After the Self-Cleaning operation has been performed for the specified period, the unit stops operating.
	Operation time	Self-Cleaning operation time													
Cooling: Auto (cooling) Dry	Up to 10 minutes	No Self-Cleaning operation performed (0 minutes)													
	10 minutes or longer	30 mins.													
Heating: Auto (heating)	No Self-Cleaning operation performed														
Auto (fan only)															
Shutdown															

Item	Operation flow and applicable data, etc.	Description																								
<p>11. Self-Cleaning function</p>	<ul style="list-style-type: none"> • Self-Cleaning diagram <table border="1" data-bbox="156 264 1433 645"> <thead> <tr> <th>Operation display</th> <th>ON</th> <th>OFF</th> <th>OFF</th> </tr> </thead> <tbody> <tr> <td>FCU fan</td> <td>ON rpm is depend on presetting.</td> <td>ON (500RPM)</td> <td>OFF</td> </tr> <tr> <td>FCU louver</td> <td>OPEN</td> <td>OPEN (11.3°)</td> <td>CLOSE</td> </tr> <tr> <td>Timer display</td> <td>ON or OFF depend on presetting of timer function.</td> <td>ON</td> <td>ON or OFF depend on presetting of timer function.</td> </tr> <tr> <td>Compressor</td> <td>ON or OFF depend on presetting per room temperature.</td> <td>OFF</td> <td>OFF</td> </tr> <tr> <td>CDU fan</td> <td>ON or OFF depend on presetting per room temperature.</td> <td>OFF</td> <td>OFF</td> </tr> </tbody> </table> <div data-bbox="331 660 1433 831"> <p style="text-align: center;">Turn off by remote controller or timer-off function. Automatically turn-off.</p> </div>	Operation display	ON	OFF	OFF	FCU fan	ON rpm is depend on presetting.	ON (500RPM)	OFF	FCU louver	OPEN	OPEN (11.3°)	CLOSE	Timer display	ON or OFF depend on presetting of timer function.	ON	ON or OFF depend on presetting of timer function.	Compressor	ON or OFF depend on presetting per room temperature.	OFF	OFF	CDU fan	ON or OFF depend on presetting per room temperature.	OFF	OFF	
Operation display	ON	OFF	OFF																							
FCU fan	ON rpm is depend on presetting.	ON (500RPM)	OFF																							
FCU louver	OPEN	OPEN (11.3°)	CLOSE																							
Timer display	ON or OFF depend on presetting of timer function.	ON	ON or OFF depend on presetting of timer function.																							
Compressor	ON or OFF depend on presetting per room temperature.	OFF	OFF																							
CDU fan	ON or OFF depend on presetting per room temperature.	OFF	OFF																							
<p>12. Remote-A or B selection</p>	<p>Setting the remote controller</p> <p>To separate using of remote control for each indoor unit in case of 2 air conditioner are installed nearby.</p> <p>Remote Control B Setup.</p> <ol style="list-style-type: none"> 1) Press RESET button on the indoor unit to turn the air conditioner ON. 2) Point the remote control at the indoor unit. 3) Push and hold CHK • button on the Remote Control by the tip of the pencil. "00" will be shown on the display. 4) Press MODE • during pushing CHK •. "B" will show on the display and "00" will disappear and the air conditioner will turn OFF. The Remote Control B is memorized. <p>Note :</p> <ol style="list-style-type: none"> 1. Repeat above step to reset Remote Control to be A. 2. Remote Control A has not "A" display. 3. Default setting of Remote Control from factory is A. <div data-bbox="432 1570 895 1753"> </div>	<ol style="list-style-type: none"> 1. Purpose This operation is to operate only one indoor unit using one remote controller. 2. Description When operating one indoor unit in a situation where two indoor units have been installed in the same room or nearby rooms, this operation prevents the remote controller signal from being received simultaneously by both units, thus preventing both units from operating. 3. Operation The indoor unit on which the remote controller selection has been set to B receives the signal of the remote controller also set to B. (At the factory the remote controller selection is set to A on all the indoor units. There is no A setting display.) 																								

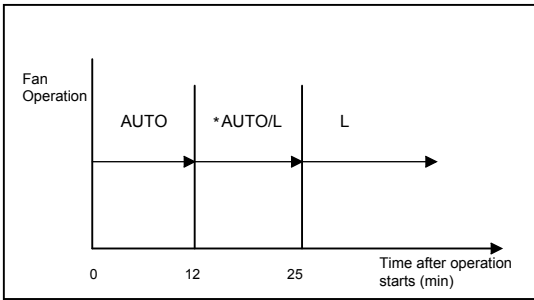
Item	Operation flow and applicable data, etc.	Description
<p>13. QUIET mode</p>	<p>When the [QUIET] button is pressed, the fan of the indoor unit will be restricted the revolving speed at speed L – until the [QUIET] button is pressed once again (cancel Quiet mode).</p>	<p>Quiet mode is the system which, control the revolving speed of indoor fan to work constantly at lower than speed L. In addition, noise level of indoor unit is less than usual.</p> <p>Remarks :</p> <ol style="list-style-type: none"> 1. Quiet mode is unable to work in dry mode. 2. Quiet mode is appropriate to work with less cooling load and less heating load condition. Because of the fan speed L- may cause not enough the cooling capacity or heating capacity.
<p>14. SLEEP mode</p>	<p>Cooling mode</p> <ul style="list-style-type: none"> • The preset temperature will increase as show on ECO operation (Item No. 9) • Press the [COMFORT SLEEP] button to choose the operating hours. Repeat pressing to select the hours. (1hr, 3hr, 5hr or 9hr) • If the [COMFORT SLEEP] button is pressed again means cancel comfort sleep mode. <p>Heating mode</p> <ul style="list-style-type: none"> • The preset temperature will drop down as show on ECO operation (Item No. 9) • Press the [COMFORT SLEEP] button to choose the operating hours. Repeat pressing to select the hours. (1hr, 3hr, 5hr or 9 hr) • If the [COMFORT SLEEP] button is pressed again means cancel comfort sleep mode. 	<p>The principles of comfort sleep mode are:</p> <ul style="list-style-type: none"> • Quietness for more comfortable. When room temperature reach setting temperature • Save energy by changing room temperature automatically. • The air condition can shut down by itself automatically. <p>Remarks:</p> <ol style="list-style-type: none"> 1. Comfort sleep mode will not operate in dry mode and fan only mode.
<p>15. One-Touch Comfort</p>	<p>One touch comfort is the fully automated operation that is set according to the preferable condition in a region.</p>  <p>*AUTO/L: Fan operates depends on the setting temperature and room temperature.</p> <p>During the One Touch Comfort mode if the indoor unit receives any signal with other operation mode, the unit will cancel the comfort mode and operates according to the signal received.</p>	<p>Operation condition for model to Europe market</p> <p>When an indoor unit receives "One Touch Comfort Signal" from the remote controller, the indoor unit operates as following.</p> <ol style="list-style-type: none"> 1) Air conditioner starts to operation when the signal is received, even if the air conditioner was OFF. 2) Operation mode is set according to room temperature, the same as AUTO mode. 3) Target temperature is 24°C. 4) Louver position is set as stored position of the operating mode. 5) Fan is controlled as followings.

Item	Operation flow and applicable data, etc.	Description
16. Hi-POWER Mode	<p>([Hi-POWER] button on the remote controller is pressed)</p> <p>When [Hi-POWER] button is pressed while the indoor unit is in Auto, Cooling or Heating operation, Hi-POWER mark is indicated on the display of the remote controller and the unit operates as follows.</p> <ol style="list-style-type: none"> 1. Automatic operation <ul style="list-style-type: none"> • The indoor unit operates in according to the current operation. 2. Cooling operation <ul style="list-style-type: none"> • The preset temperature drops 1°C (The value of the preset temperature on the remote controller does not change.) The indoor unit's fan speed level increase 1 tap 3. Heating operation <ul style="list-style-type: none"> • The preset temperature increases 2°C (The value of the preset temperature on the remote controller does not change.) The indoor unit's fan speed level increase 1 tap 4. The Hi-POWER mode can not be set in Dry operation 	

9-3. Auto Restart Function

This indoor unit is equipped with an automatic restarting function which allows the unit to restart operating with the set operating conditions in the event of a power supply being accidentally shut down.

The operation will resume without warning three minutes after power is restored.

This function is not set to work when shipped from the factory. Therefore it is necessary to set it to work.

9-3-1. How to Set the Auto Restart Function

To set the auto restart function, proceed as follows:

The power supply to the unit must be on ; the function will not set if the power is off.

Press the [RESET] button located in the center of the front panel continuously for three seconds.

The unit receives the signal and beeps three times.

The unit then restarts operating automatically in the event of power supply being accidentally shut down.

- **When the unit is standby (Not operating)**

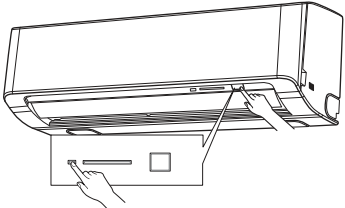
Operation	Motions
<p>Press [RESET] button for more than three seconds. (Less than 10 seconds)</p> 	<p>The unit is on standby.</p> <p style="text-align: center;">↓</p> <p>The unit starts to operate. The green indicator is on.</p> <p style="text-align: center;">↓ After approx. three seconds,</p> <p>The unit beeps three times and continues to operate. The green indicator flashes for 5 seconds.</p> <p>If the unit is not required to operate at this time, press [RESET] button once more or use the remote controller to turn it off.</p>

- **When the unit is in operation**

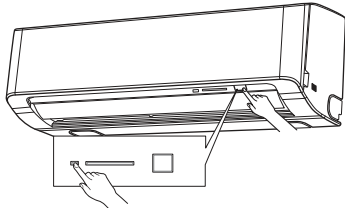
Operation	Motions
<p>Press [RESET] button for more than three seconds. (Less than 10 seconds)</p> 	<p>The unit is in operation. The green indicator is on.</p> <p style="text-align: center;">↓</p> <p>The unit stops operating. The green indicator is turned off.</p> <p style="text-align: center;">↓ After approx. three seconds,</p> <p>The unit beeps three times. The green indicator flashes for 5 seconds.</p> <p>If the unit is required to operate at this time, press [RESET] button once more or use the remote controller to turn it on.</p>

- While the filter check indicator is on, the RESET button has the function of filter reset button.

9-3-2. How to Cancel the Auto Restart Function

To cancel auto restart function, proceed as follows :

Repeat the setting procedure : the unit receives the signal and beeps three times.

The unit will be required to be turned on with the remote controller after the main power supply is turned off.

• **When the system is on stand-by (not operating)**

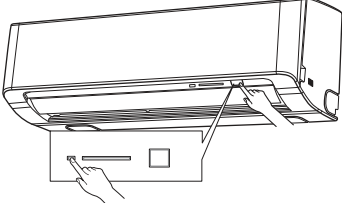
Operation	Motions
<p>Press [RESET] button for more than three seconds. (Less than 10 seconds)</p> 	<p>The unit is on standby.</p> <p style="text-align: center;">↓</p> <p>The unit starts to operate. The green indicator is on.</p> <p style="text-align: center;">↓ After approx. three seconds,</p> <p>The unit beeps three times and continues to operate.</p> <p>If the unit is not required to operate at this time, press [RESET] button once more or use the remote controller to turn it off.</p>

• **When the system is operating**

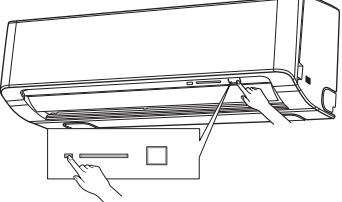
Operation	Motions
<p>Press [RESET] button for more than three seconds. (Less than 10 seconds)</p> 	<p>The unit is in operation. The green indicator is on.</p> <p style="text-align: center;">↓</p> <p>The unit stops operating. The green indicator is turned off.</p> <p style="text-align: center;">↓ After approx. three seconds,</p> <p>The unit beeps three times.</p> <p>If the unit is required to operate at this time, press [RESET] button once more or use the remote controller to turn it on.</p>

9-3-3. Power Failure During Timer Operation

When the unit is turned off because of power failure during timer operation, the timer operation is cancelled. In that case, set the timer operation again.

NOTE :

The daily timer is reset while a command signal can be received from the remote controller even if it stopped due to a power failure.

9-4. Remote Controller and Its Functions

9-4-1. Parts Name of Remote Controller

- ① Infrared signal emitter
- ② Start/Stop button
- ③ Mode select button (MODE)
- ④ Temperature button (TEMP)
- ⑤ Fan speed button (FAN)
- ⑥ Swing louver button (SWING)
- ⑦ Set louver button (FIX)
- ⑧ On timer button (ON)
- ⑨ Off timer button (OFF)
- ⑩ Setup button (SET)
- ⑪ Clear button (CLR)
- ⑫ Memory and Preset button (PRESET)
- ⑬ One-Touch button (ONE-TOUCH)
- ⑭ High power button (Hi-POWER)
- ⑮ Economy button (ECO)
- ⑯ Quiet button (QUIET)
- ⑰ Comfort sleep button (COMFORT SLEEP)
- ⑱ Filter reset button (FILTER)
- ⑲ Set clock button (CLOCK)
- ⑳ Check button (CHECK)
- ㉑ Reset button (RESET)

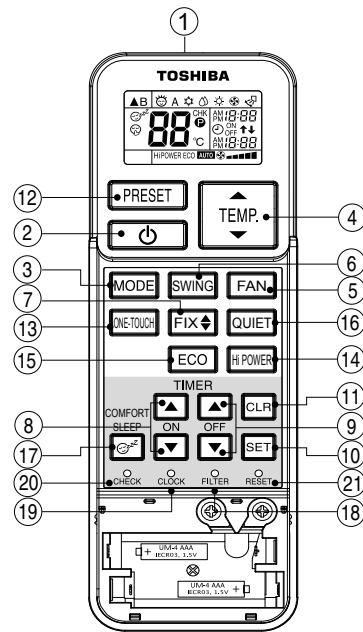

Note:

- The provided Remote Controller is a wireless type, which also can be used as a wire.
Please see "How to Connect The Remote Controller for Wired Operation", located in installation instruction, in case of wired control is required.
- In wire operation, remote controller will return to initial condition (PRESET, TIMER and CLOCK will return to initial condition) when user shutdown power supply of Air conditioner.

9-4-2. Operation of remote control

1. ONE-TOUCH

Press the "ONE-TOUCH" button for fully automated operation that is customised to the typical consumer preferences in your region of the world. The customised settings control temperature air flow strength, air flow direction and other settings to provide you alternate contact with "ONE-TOUCH" OF THE BUTTON. If you prefer other settings you can select from the many other operation functions of your Toshiba unit

Press ● ONE-TOUCH : Start the operation.









2. AUTOMATIC OPERATION

To automatically select cooling, heating, or fan only operation.

1. Press ● MODE : Select A.
2. Press  MODE : Set the desired temperature.



3. COOLING / HEATING / FAN ONLY OPERATION

To automatically select cooling, heating, or fan only operation.

1. Press ● MODE : Select Cool , Heat , or Fan only .
2. Press  MODE : Set the desired temperature.
Cooling: Min. 17°C, Heating : Max, 30°C, Fan Only: No temperature indication
3. Press ● FAN : Select AUTO, LOW , LOW+ , MED , MED+ , or HIGH .

4. DRY OPERATION (COOLING ONLY)

For dehumidification, a moderate cooling performance is controlled automatically.

1. Press  MODE : Select Dry .
2. Press  MODE : Set the desired temperature.

5. HI-POWER OPERATION

To automatically control room temperature and airflow for faster cooling or heating operation (except in DRY and FAN ONLY mode)

Press  HI-POWER : Start and stop the operation.

6. ECO OPERATION

To automatically control room to save energy (except in DRY and FAN ONLY mode)

Press  ECO : Start and stop the operation.







Note: Cooling operation; the set temperature will increase automatically 0.5 degree/ hour for 4 hours (maximum 2 degrees increase). For heating operation the set temperature will decrease.

7. TEMPORARY OPERATION

In case of the misplaced or discharged remote control





- Pressing the RESET button, the unit can start or stop without using the remote control.
- Operation mode is set on AUTOMATIC operation, preset temperature is 24°C and fan operation is automatic speed.

8. TIMER OPERATION

Setting the ON Timer		Setting the OFF Timer	
1	Press  : Set the desired ON timer.	Press  : Set the desired OFF timer.	
2	Press  : Set the timer	Press  : Set the timer.	
3	Press  : Cancel the timer	Press 	

Daily timer allows the user to set both the ON & OFF timers and will be activated on a daily basis.

Setting Daily Timer

1	Press  : Set the ON timer.	3	Press  .
2	Press  : Set the OFF timer.	4	Press  button during the (↑ or ↓) mark flashing.

- During the daily timer is activation, both arrows (↑ or ↓) are indicated.

Note:

- Keep the remote control in accessible transmission to the indoor unit; otherwise, the time lag of up to 15 minutes will occur.
- The setting will be saved for the next same operation.

9. PRESET OPERATION

Set your preferred operation for future use. The setting will be memorized by the unit for future operation (except air flow direction).

1. Select your preferred operation.
2. Press and hold ● PRESET for 3 seconds to memorize the setting. The ● mark displays.
3. Press ● PRESET : Operate the preset operation.

10. AUTO RESTART OPERATION

To automatically restart the conditioner after the power failure (Power of the unit must be on.)

Setting

1. Press and hold the RESET button on the indoor unit for 3 seconds to set the operation. (3 beep sound and OPERATION lamp blink 5 time/sec for 5 secprds)
 - Do not operate ON timer and OFF timer.
2. Press and hold the RESET button on the indoor unit for 3 seconds to cancel the operation. (3 beep sound but OPERATION lamp does not blink)

11. QUIET OPERATION

To operate at super low fan speed for quiet operation (except in DRY mode)

Press ● QUIET : Start and stop the operation.

Note: Under certain conditions, QUIET operation may not provide adequate cooling or heating due to low sound features.

12. COMFORT SLEEP OPERATION

To save energy while sleeping, automatically control air flow and automatically turn OFF.

Press ● COMFORT SLEEP : Select 1, 3, 5 or 9 hrs for OFF timer operation.

Note: The cooling operation, the set temperature will increase automatically 0.5 degree/hour for 4 hours (maximum 2 degrees increase). For heating operation, the set temperature will decrease.





9-4-3. Name and Functions of Indications on Remote Controller

All indications, except for the clock time indicator, are displayed by pressing the  button.

1. Transmission mark

This transmission mark ▲ indicates when the remote controller transmits signals to the indoor unit.







2. Mode indicator

Indicates the current operation mode.
(A : Auto,  : Cool,  : Dry,  : Heat,  : Fan only)

3. Temperature indicator

Indicates the temperature setting.
(17°C to 30°C)

4. FAN speed indicator

Indicates the selected fan speed.
AUTO or five fan speed levels
(LOW , LOW+ , MED , MED+ , HIGH ) can be shown.
Indicate Auto will be appear with Dry operation
( : Dry) only.

5. TIMER and clock time indicator

The time setting for timer operation or the clock time is indicated.
The current time is always indicated except during TIMER operation.

6. Hi-POWER indicator

Indicates when the Hi-POWER operation starts.
Press the Hi-POWER button to start and press it again to stop the operation.

7.  (PRESET) indicator

Flashes for 3 seconds when the PRESET button is pressed during operation.
The  mark is shown when holding down the button for more than 3 seconds while the mark is blinks.
Press another button to turn off the mark.

8. ECO indicator

Indicates when the ECO is in activated.
Press the ECO button to start and press it again to stop operation.

9. A, B change indicator remote controller

When the remote controller switching function is set, "B" appears in the remote controller display.
(When the remote controller setting is "A", there is no indication at this position.)

10. Comfort sleep

Indicates when comfort sleep is activated.
Press comfort sleep button to select

11. Quiet

Indicates when quiet is activated.
Press quiet button to start and press it again to stop operation.

12. One-Touch

Indicates when one touch comfort is activated.
Press one-touch button to start the operation.

13. Swing

Indicates when louver is swing.
Press swing button to start the swing operation and press it again to stop the swing operation.

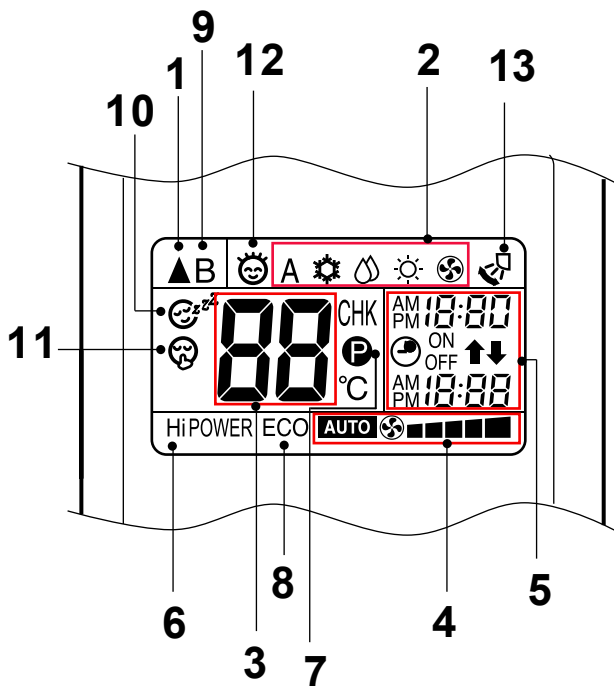

10. INSTALLATION PROCEDURE

10-1-1. Installation Diagram of Indoor and Outdoor Units

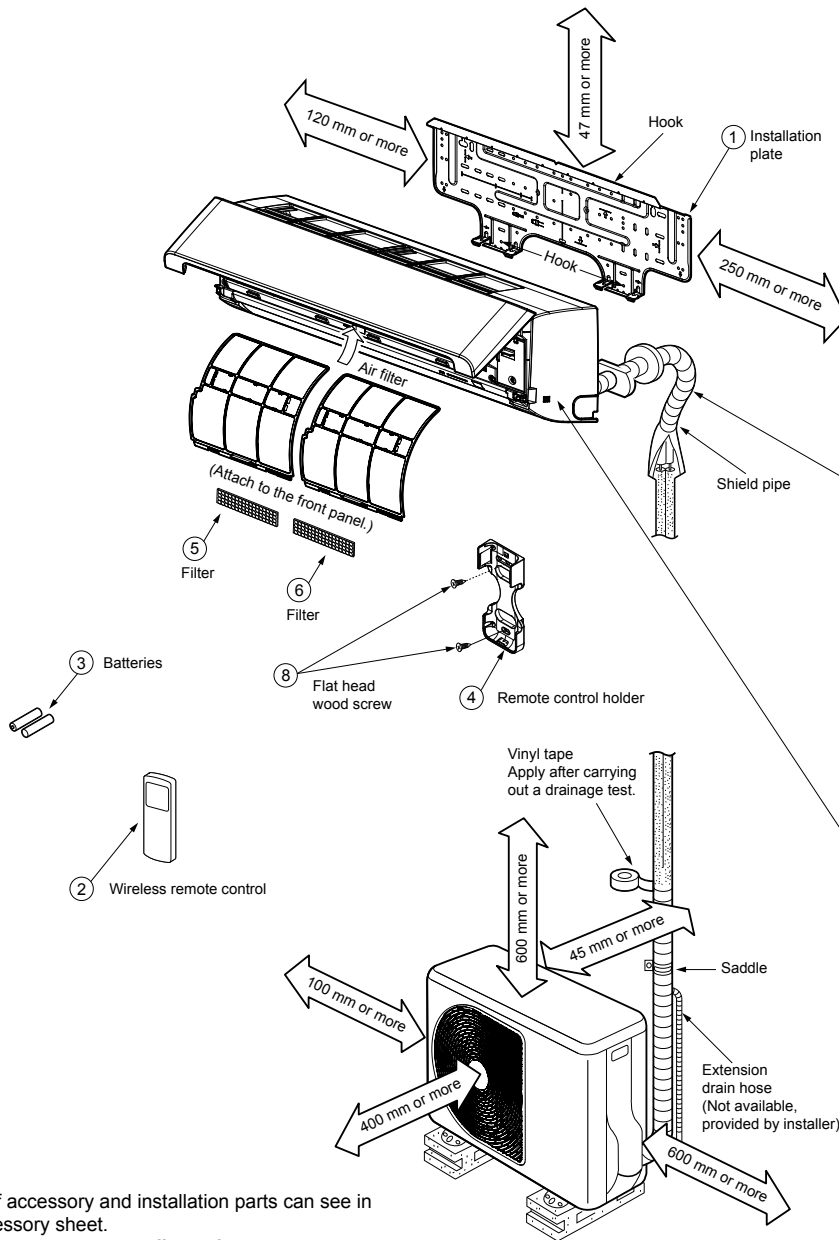

For the rear left and left piping

Insert the cushion between the indoor unit and wall, and tilt the indoor unit for better operation.

Do not allow the drain hose to get slack.

Cut the piping hole sloped slightly. Make sure to run the drain hose sloped downward.

The auxiliary piping can be connected to the left, rear left, rear right, right, bottom right or bottom left.

Insulate the refrigerant pipes separately with insulation, not together.

6 mm thick heat resisting polyethylene foam

Remark :

- Detail of accessory and installation parts can see in the accessory sheet.
- Some pictures might be different from the actual parts.

Before installing the wireless remote controller

- **Loading Batteries**
 1. Remove the battery cover.
 2. Insert 2 new batteries (AAA type) following the (+) and (-) positions.

② Wireless remote controller ③ Batteries





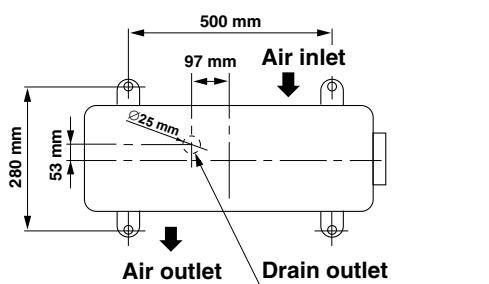

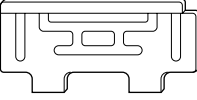

10-1-2. Optional installation parts

Part Code	Parts name	Q'ty
A	Refrigerant piping Liquid side : $\varnothing 6.35$ mm Gas side : $\varnothing 9.52$ mm	One each
B	Pipe insulating material (polyethylene foam, 6 mm thick)	1
C	Putty, PVC tapes	One each

<Fixing bolt arrangement of outdoor unit>**Fig. 9-1-2**

- Secure the outdoor unit with fixing bolts and nuts if the unit is likely to be exposed to a strong wind.
- Use $\varnothing 8$ mm or $\varnothing 10$ mm anchor bolts and nuts.
- If it is necessary to drain the defrost water, attach drain nipple ⑩ and cap water proof ⑪ to the bottom plate of the outdoor unit before installing it.

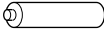
10-1-3. Accessory and installation parts

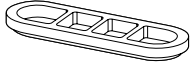
Part No.	Part name (Q'ty)	Part No.	Part name (Q'ty)	Part No.	Part name (Q'ty)			
①	 Installation plate x 1	④	 Remote control holder x 1	⑦	 Mounting screw $\varnothing 4 \times 25 \text{ l} \times 6$			
②	 Wireless remote control x 1	⑤	 Toshiba new IAQ filter x 1	⑧	 Flat head wood screw $\varnothing 3.1 \times 16 \text{ l} \times 2$			
③	 Battery x 2	⑥	 Toshiba new IAQ filter x 1	⑨	 Drain nipple* x 1			
Others	<table border="1"> <thead> <tr> <th>Name</th> </tr> </thead> <tbody> <tr> <td>Owner's manual</td> </tr> <tr> <td>Installation manual</td> </tr> </tbody> </table>	Name	Owner's manual	Installation manual			⑩	 Cap water proof x 2
Name								
Owner's manual								
Installation manual								







The part marked with asterisk (*) is packaged with the outdoor unit.

10-1-4. Installation/Service Tools**<Changes in the product and components>**

In the case of an air conditioner using R410A, in order to prevent any other refrigerant from being charged accidentally, the service port diameter of the outdoor unit control valve (3 way valve) has been changed. (1/2 UNF 20 threads per inch)

- In order to increase the pressure resisting strength of the refrigerant piping, flare processing diameter and size of opposite side of flare nuts has been changed. (for copper pipes with nominal dimensions 1/2 and 5/8)

New tools for R410A

New tools for R410A	Applicable to R22 model		Changes
Gauge manifold	×		As pressure is high, it is impossible to measure by means of conventional gauge. In order to prevent any other refrigerant from being charged, each port diameter has been changed.
Charge hose	×		In order to increase pressure resisting strength, hose materials and port size have been changed (to 1/2 UNF 20 threads per inch). When purchasing a charge hose, be sure to confirm the port size.
Electronic balance for refrigerant charging	○		As pressure is high and gasification speed is fast, it is difficult to read the indicated value by means of charging cylinder, as air bubbles occur.
Torque wrench (nominal diam. 1/2, 5/8)	×		The size of opposite sides of flare nuts have been increased. Incidentally, a common wrench is used for nominal diameters 1/4 and 3/8.
Flare tool (clutch type)	○		By increasing the clamp bar's receiving hole, strength of spring in the tool has been improved.
Gauge for projection adjustment	—		Used when flare is made by using conventional flare tool.
Vacuum pump adapter	○		Connected to conventional vacuum pump. It is necessary to use an adapter to prevent vacuum pump oil from flowing back to the charge hose. The charge hose connecting part has two ports-one for conventional refrigerant (7/16 UNF 20 threads per inch) and one for R410A. If the vacuum pump oil (mineral) mixes with R410A a sludge may occur and damage the equipment.
Gas leakage detector	×		Exclusive for HFC refrigerant.

- Incidentally, the "refrigerant cylinder" comes with the refrigerant designation (R410A) and protector coating in the U. S.'s ARI specified rose color (ARI color code: PMS 507).
- Also, the "charge port and packing for refrigerant cylinder" require 1/2 UNF 20 threads per inch corresponding to the charge hose's port size.

10-2. Indoor Unit

10-2-1. Installation place

- A place which provides the spaces around the indoor unit as shown in the above diagram.
- A place where there is no obstacle near the air inlet and outlet.
- A place that allows easy installation of the piping to the outdoor unit.
- A place which allows the front panel to be opened.
- The indoor unit shall be installed as top of the indoor unit comes to at least 2 m height.
Also, it must be avoided to put anything on the top of the indoor unit.

- Direct sunlight to the indoor unit's wireless receiver should be avoided.
- The microprocessor in the indoor unit should not be too close to RF noise sources.
(For details, see the owner's manual.)

<Remote control>

- A place where there are no obstacles such as a curtain that may block the signal from the indoor unit.
- Do not install the remote control in a place exposed to direct sunlight or close to a heating source, such as a stove.
- Keep the remote control at least 1 m apart from the nearest TV set or stereo equipment. (This is necessary to prevent image disturbances or noise interference.)
- The location of the remote control should be determined as shown below.

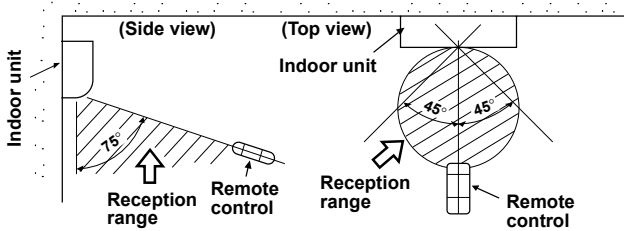

Fig. 10-2-1

10-2-2. Cutting a hole and mounting installation plate

<Cutting a hole>

When installing the refrigerant pipes from the rear.

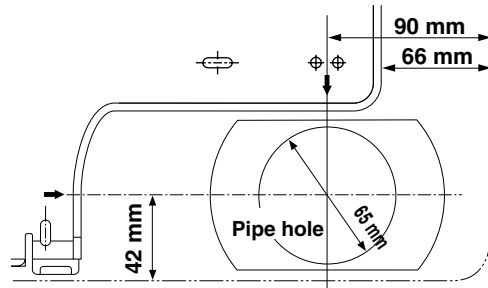

Fig. 10-2-2

1. After determining the pipe hole position on the mounting plate (→), drill the pipe hole (Ø65 mm) at a slight downward slant to the outdoor side.

NOTE:

- When drilling a wall that contains a metal lath, wire lath or metal plate, be sure to use a pipe hole brim ring sold separately.

<Mounting the installation plate>

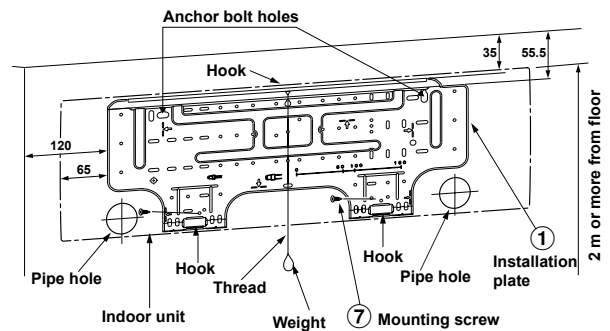

Fig. 10-2-3

<When the installation plate is directly mounted on the wall>

1. Securely fit the installation plate onto the wall by screwing it in the upper and lower parts to hook up the indoor unit.
2. To mount the installation plate on a concrete wall with anchor bolts, utilize the anchor bolt holes as illustrated in the above figure.
3. Install the installation plate horizontally in the wall.

When installing the installation plate with a mounting screw, do not use the anchor bolt hole. Otherwise the unit may fall down and result in personal injury and property damage.

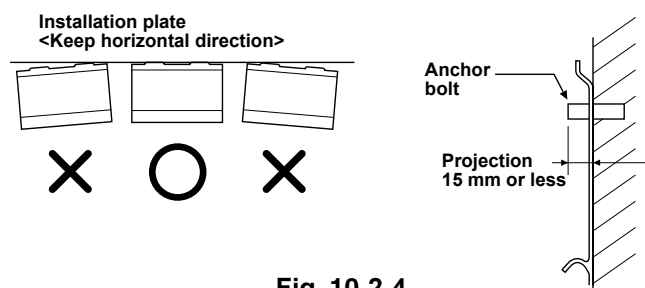

Fig. 10-2-4

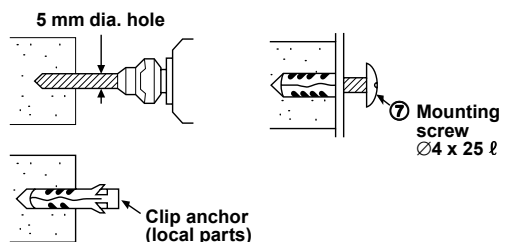

Fig. 10-2-5

Failure to firmly install the unit may result in personal injury and property damage if the unit falls.

- In case of block, brick, concrete or similar type walls, make 5 mm dia. holes in the wall.
- Insert clip anchors for appropriate mounting screws ⑦.

NOTE:

- Secure four corners and lower parts of the installation plate with 4 to 6 mounting screws to install it.

10-2-3. Electrical work

1. The supply voltage must be the same as the rated voltage of the air conditioner.
2. Prepare the power source for exclusive use with the air conditioner.

NOTE

- Wire type : More than H07RN-F or 60245 IEC66 (1.5 mm² or more).

This appliance can be connected to the mains in either of the following two ways.

- (1) Connection to fixed wiring:
A switch or circuit breaker which disconnects all poles and has a contact separation of at least 3 mm must be incorporate in the fixed wiring. An approved circuit breaker or switches must used.
- (2) Connection with power supply plug:
Attach power supply plug with power cord and plug it into wall outlet. An approved power supply cord and plug must be used.

NOTE:

- Perform wiring works so as to allow a general wiring capacity.

10-2-4. Wiring connection

<How to connect the connecting cable>

Wiring of the connecting cable can be carried out without removing of the front panel.

1. Remove the air inlet grille.
Open the air inlet grille upward and pull it toward you.
2. Remove the terminal cover and cord clamp.
3. Insert the connecting cable (according to the local cords) into the pipe hole on the wall.
4. Take out the connecting cable through the cable slot on the rear panel so that it protrudes about 15 cm from the front.
5. Insert the connecting cable fully into the terminal block and secure it tightly with screws.
6. Tightening torque : 1.2 N·m (0.12 kgf·m)
7. Secure the connecting cable with the cord clamp.
8. Fix the terminal cover, rear plate bushing and air inlet grille on the indoor unit.

- Be sure to refer to the wiring system diagram labeled inside the front panel.
- Check local electrical cords and also any specific wiring instructions or limitations.

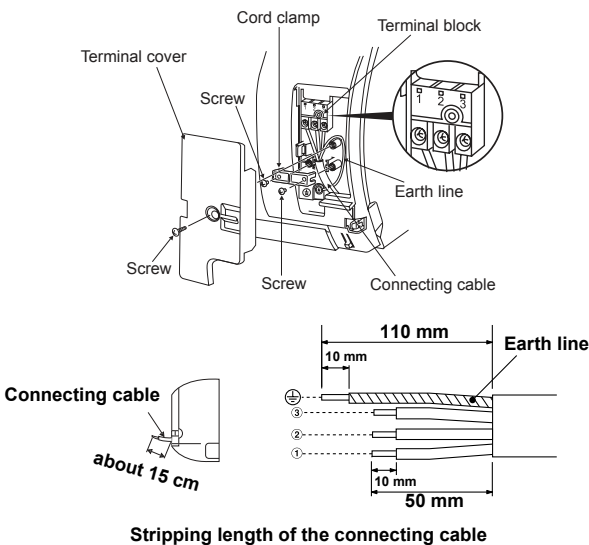

NOTE :

- Use stranded wire only.
- Wire type : More than H07RN-F or 60245 IEC66 (1.0 mm² or more).

<How to install the air inlet grille on the indoor unit>

- When attaching the air inlet grille, the contrary of the removed operation is performed.

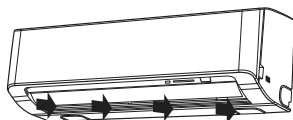

10-2-5. Piping and drain hose installation

<Piping and Drain Hose Forming>

- * Since dewing results in a machine trouble, make sure to insulate both the connecting pipes. (Use polyethylene foam as insulating material.)

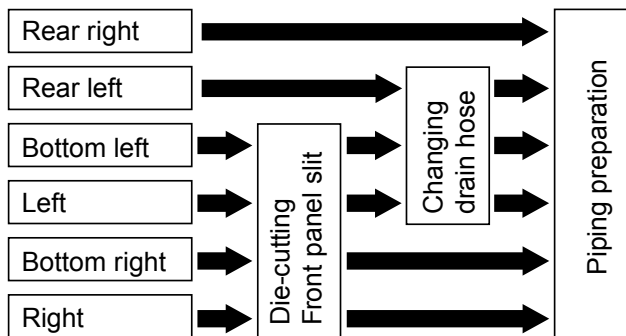

Fig. 10-2-8

1. Die-cutting Front panel slit

Cut out the slit on the leftward or right side of the front panel for the left or right connection and the slit on the bottom left or right side of the front panel for the bottom left or right connection with a pair of nippers.

2. Changing drain hose

For leftward connection, bottom-leftward connection and rearleftward connection's piping, it is necessary to change the drain hose and drain cap.

<How to remove the Drain Cap>

Clip the drain cap by needle-nose pliers and pull out.

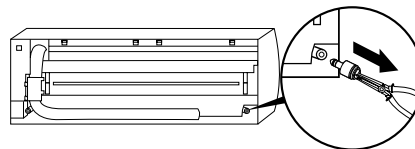

Fig. 10-2-9

<How to remove the drain hose>

- The drain hose can be removed by removing the screw securing the drain hose and then pulling out the drain hose.
- When removing the drain hose, be careful of any sharp edges of steel plate. The edges can injuries.
- To install the drain hose, insert the drain hose firmly until the connection part contacts with heat insulator, and the secure it with original screw.

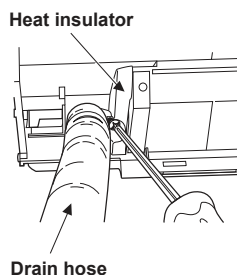

Fig. 10-2-10

<How to fix the Drain Cap>

- 1) Insert hexago wrench (4 mm) in a center head.

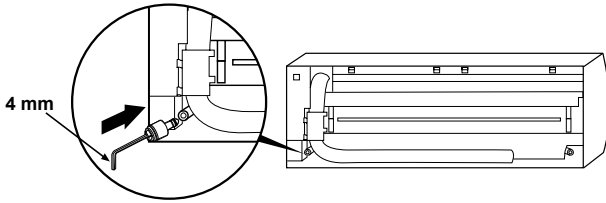

Fig. 10-2-11

- 2) Firmly insert drain cap.

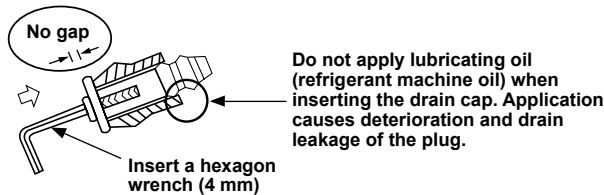

Fig. 10-2-12

Firmly insert the drain hose and drain cap; otherwise, water may leak.

<In case of right or left piping>

- After scribing slits of the front panel with a knife or a making-off pin, cut them with a pair of nippers or an equivalent tool.

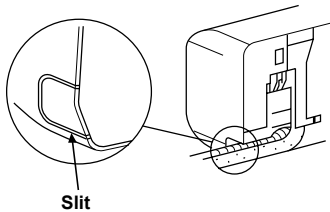

Fig. 10-2-13

<In case of bottom right or bottom left piping>

- After scribing slits of the front panel with a knife or a making-off pin, cut them with a pair of nippers or an equivalent tool.

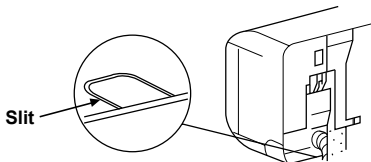

Fig. 10-2-14

<Left-hand connection with piping>

Bend the connecting pipe so that it is laid within 43 mm above the wall surface. If the connecting pipe is laid exceeding 43 mm above the wall surface, the indoor unit may unstably be set on the wall. When bending the connecting pipe, make sure to use a spring bender so as not to crush the pipe.

Bend the connection pipe within a radius of 30 mm.

To connect the pipe after installation of the unit (figure)

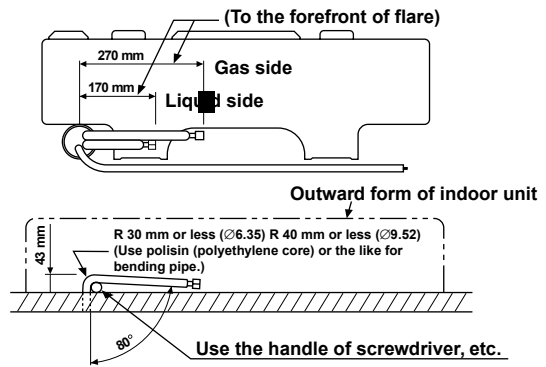

Fig. 10-2-15

NOTE:

If the pipe is bent incorrectly, the indoor unit may unstably be set on the wall. After passing the connecting pipe through the pipe hole, connect the connecting pipe to the auxiliary pipes and wrap the facing tape around them.

- Bind the auxiliary pipes (two) and connecting cable with facing tape tightly. In case of leftward piping and rear-leftward piping, bind the auxiliary pipes (two) only with facing tape.

Fig.10-2-16

- Carefully arrange pipes so that any pipe does not stick out of the rear plate of the indoor unit.
- Carefully connect the auxiliary pipes and connecting pipes to each other and cut off the insulating tape wound on the connecting pipe to avoid double-taping at the joint, moreover, seal the joint with the vinyl tape, etc.
- Since dewing results in a machine trouble, make sure to insulate both the connecting pipes. (Use polyethylene foam as insulating material.)
- When bending a pipe, carefully do it not to crush it.

10-2-6. Indoor unit fixing

1. Pass the pipe through the hole in the wall, and hook the indoor unit on the installation plate at the upper hooks.
2. Swing the indoor unit to right and left to confirm that it is firmly hooked up on the installation plate.
3. While pressing the indoor unit onto the wall, hook it at the lower part on the installation plate. Pull the indoor unit toward you to confirm that it is firmly hooked up on the installation plate.

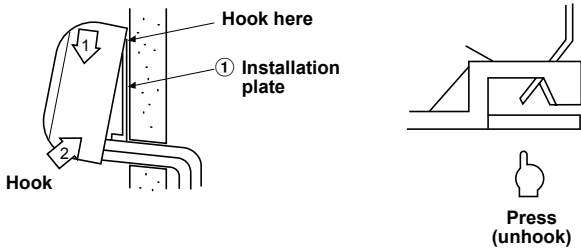

Fig. 10-2-17

- For detaching the indoor unit from the installation plate, pull the indoor unit toward you while pushing its bottom up at the specified parts.

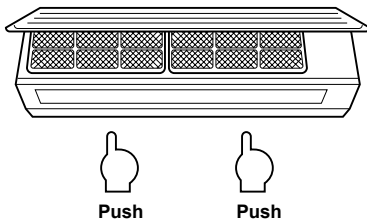

Fig. 10-2-18

10-2-7. Drainage

1. Run the drain hose sloped downwards.

NOTE

- Hole should be made at a slight downward slant on the outdoor side.

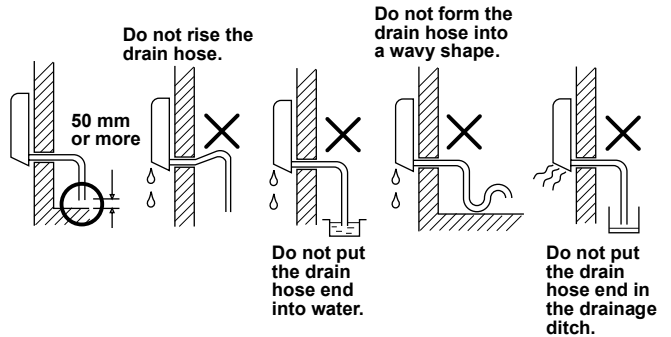

Fig. 10-2-19

2. Put water in the drain pan and make sure that the water is drained out of doors.
3. When connecting extension drain hose, insulate the connecting part of extension drain hose with shield pipe.

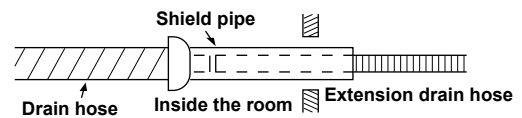

Fig. 10-2-20

Arrange the drain pipe for proper drainage from the unit.
Improper drainage can result in dew-dropping.

This air conditioner has the structure designed to drain water collected from dew, which forms on the back of the indoor unit, to the drain pan. Therefore, do not store the power cord and other parts at a height above the drain guide.

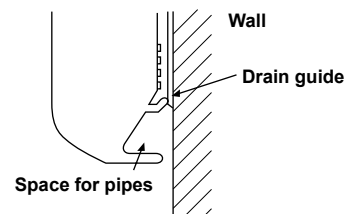

Fig. 10-2-21

10-3. Outdoor Unit

10-3-1. Installation place

- A place which provides the spaces around the outdoor unit as shown in the left diagram.
- A place which can bear the weight of the outdoor unit and does not allow an increase in noise level and vibration.
- A place where the operation noise and discharged air do not disturb users neighbors.
- A place which is not exposed to a strong wind.
- A place free of a leakage of combustible gases.
- A place which does not block a passage.
- When the outdoor unit is to be installed in an elevated position, be sure to secure its feet.
- An allowable length of the connecting pipe is up to 10 m.
- An allowable height level is up to 8 m.
- A place where the drain water does not raise any problem.

1. Install the outdoor unit without anything blocking the air discharging.
2. When the outdoor unit is installed in a place exposed always exposed to strong wind like a coast or on a high storey of a building, secure the normal fan operation using a duct or a wind shield.
3. In particularly windy areas, install the unit such as to avoid admission of wind.
4. Installation in the following places may result in trouble.
Do not install the unit in such places.
 - A place full of machine oil.
 - A saline-place such as the coast.
 - A place full of sulfide gas.
 - A place where high-frequency waves are likely to be generated as from audio equipment, welders, and medical equipment.

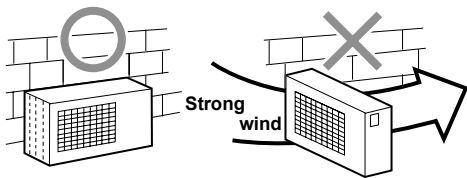

Fig. 10-3-1

10-3-2. Refrigerant piping connection

<Flaring>

1. Cut the pipe with a pipe cutter.

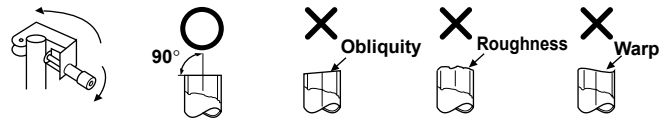

Fig. 10-3-2

2. Insert a flare nut into the pipe, and flare the pipe.
 - **Projection margin in flaring : A (Unit : mm)**

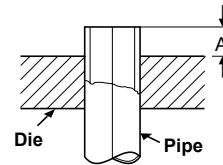

Fig. 10-3-3

Rigid (Clutch type)

Outer dia. of copper pipe	R410A tool used	Conventional tool used
Ø 6.35	0 to 0.5	1.0 to 1.5
Ø 9.52	0 to 0.5	1.0 to 1.5

Imperial (wing nut type)

Outer dia. of copper pipe	R410A
Ø 6.35	1.5 to 2.0
Ø 9.52	1.5 to 2.0

<Tightening connection>

Align the centers of the connecting pipes and tighten the flare nut as far as possible with your fingers. Then tighten the nut with a spanner and torque wrench as shown in the figure.

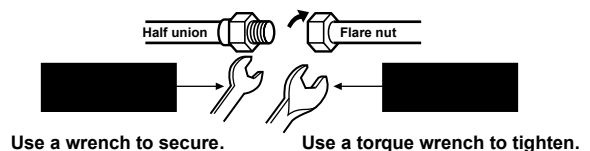

Fig. 10-3-4

CAUTION

- Do not apply excess torque.
- Otherwise, the nut may crack depending on the conditions.

(Unit : Nám)

Outer dia. of copper pipe	Tightening torque
Ø6.35 mm	16 to 18 (1.6 to 1.8 kgf·m)
Ø9.52 mm	30 to 42 (3.0 to 4.2 kgf·m)

• **Tightening torque of flare pipe connections**

The operating pressure of R410A is higher than that of R22. (Approx. 1.6 times).

It is therefore necessary to firmly tighten the flare pipe connecting sections (which connect the indoor and outdoor units) up to the specified tightening torque. Incorrect connections may cause not only a gas leakage, but also damage to the refrigerant cycle.

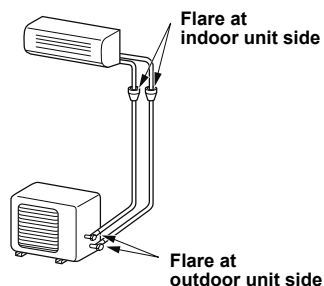

Fig. 10-3-5

<Shaping pipes>

1. How to shape the pipes
Shape the pipes along the incused line on the outdoor unit.
2. How to fit position of the pipes
Put the edges of the pipes to the place with a distance of 85 mm from the incused line.

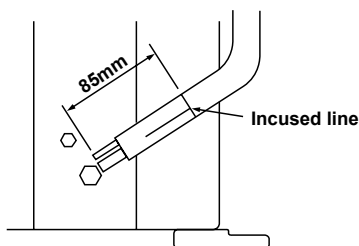

Fig. 10-3-6

10-3-3. Evacuating

After the piping has been connected to the indoor unit, you can perform the air purge together at once.

AIR PURGE

Evacuate the air in the connecting pipes and in the indoor unit using a vacuum pump. Do not use the refrigerant in the outdoor unit. For details, see the manual of the vacuum pump.

<Using a vacuum pump>

Be sure to use a vacuum pump with counter-flow prevention function so that inside oil of the pump does not flow backward into pipes of the air conditioner when the pump stops. (If oil inside of the vacuum pump enters into the air conditioner, which use R410A, refrigeration cycle trouble may result.)

1. Connect the charge hose from the manifold valve to the service port of the gas side packed valve.
2. Connect the charge hose to the port of the vacuum pump.
3. Open fully the low pressure side handle of the gauge manifold valve.
4. Operate the vacuum pump to start evacuating. Perform evacuating for about 15 minutes if the piping length is 20 meters. (15 minutes for 20 meters) (assuming a pump capacity of 27 liters per minute. Then confirm that the compound pressure gauge reading is -101 kPa (-76 cmHg).
5. Close the low pressure side valve handle of gauge manifold.
6. Open fully the valve stem of the packed valves (both side of Gas and Liquid).
7. Remove the charging hose from the service port.
8. Securely tighten the caps on the packed valves.

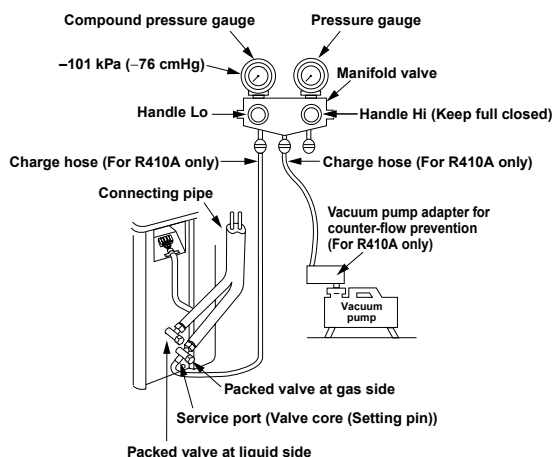

Fig.10-3-7

• **KEEP IMPORTANT 5 POINTS FOR PIPING WORK**

- (1) Take away dust and moisture (Inside of the connecting pipes.)
- (2) Tight connection (between pipes and unit)
- (3) Evacuate the air in the connecting pipes using VACUUM PUMP.
- (4) Check gas leak (connected points)
- (5) Be save to fully open the packed valves before operation.

<Packed valve handling precautions>

- Open the valve stem all the way out, but do not try to open it beyond the stopper.

Pipe size of Packed Valve	Size of Hexagon wrench
12.70 mm and smaller	A = 4 mm
15.88 mm	A = 5 mm

- Securely tighten the valve cap with torque in the following table

Cap	Cap Size (H)	Torque
Valve Rod Cap	H17 - H19	14~18 N.m (1.4 to 1.8 kgf·m)
	H22 - H30	33~42 N.m (3.3 to 4.2 kgf·m)
Service Port Cap	H14	8~12 N.m (0.8 to 1.2 kgf·m)
	H17	14~18 N.m (1.4 to 1.8 kgf·m)

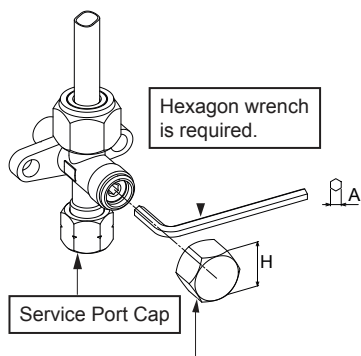

Fig. 10-4-8

10-4-5. Wiring connection

1. Remove the valve cover from the outdoor unit.
2. Connect the connecting cable to the terminals as identified with their respective matched numbers on the terminal block of indoor and outdoor unit.
3. When connecting the connecting cable to the outdoor unit terminals, make a loop as shown in the installation diagram of indoor and outdoor unit to prevent water coming in the outdoor unit.
4. Insulate the unused cords (conductors) from any water coming in the outdoor unit. Proceed them so that they do not touch any electrical or metal parts.

<Stripping length of the connecting cable>

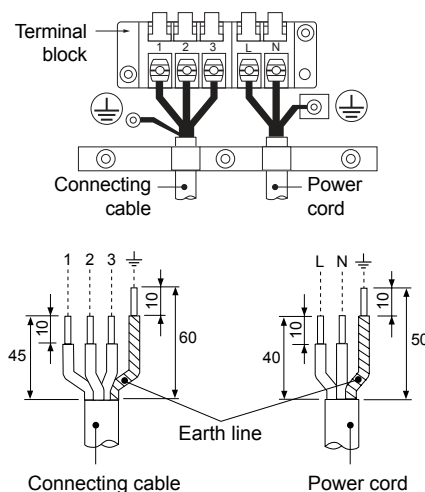

Fig. 10-4-9

Power source	50Hz, 220 - 240V Single phase 60Hz, 220V Single phase
Maximum running current	5.0A
Circuit breaker	6.5A
Power cord	H07RN-F or 60245 IEC66 (1.5 mm ² or more)

CAUTION

- Wrong wiring connection may cause some electrical parts burn out.
- Be sure to comply with local cords on running the wire from indoor unit to outdoor unit (size of wire and wiring method, etc.).
- Every wire must be connected firmly.
- This installation circuit breaker must be used specified for the power supply line of this air conditioner.
- If incorrect or incomplete wiring is carried out, it will cause an ignition or smoke.
- Prepare the power supply for exclusive use with the air conditioner.
- This product can be connected to the mains. Connection to fixed wiring: A switch which disconnects all poles and has a contact separation of at least 3 mm must be incorporated in the fixed wiring

NOTE : Connecting cable

- Wire type : More than H07RN-F or 60245 IEC66 (1.0 mm² or more).

10-5. Others

10-5-1. Gas leak test

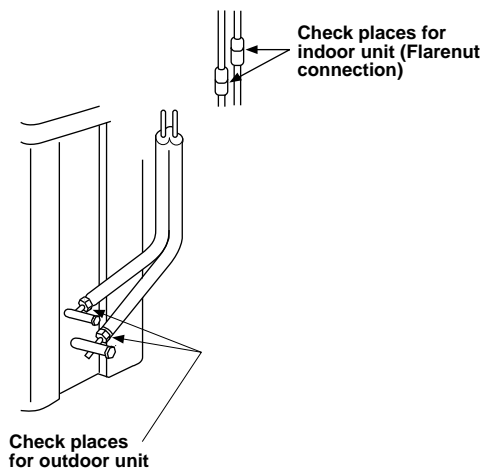

Fig. 10-5-1

- Check the flare nut connections for the gas leak with a gas leak detector or soap water.

10-5-2. Remote Control A-B Selection

- When two indoor units are installed in the same room or adjacent two rooms, if operating a unit, two units may receive the remote control signal simultaneously and operate. In this case, the operation can be preserved by setting either one remote control to B setting. (Both are set to A setting in factory shipment.)
- The remote control signal is not received when the settings of indoor unit and remote control are different.
- There is no relation between A setting/B setting and A room/B room when connecting the piping and cables.

<Remote control A-B selection>

To separate using of remote control for each indoor unit in case of 2 air conditioners are installed nearby.

<Remote Control B Setup>

1. Press [RESET] button on the indoor unit to turn the air conditioner ON.
2. Point the remote control at the indoor unit.
3. Push and hold [CHECK] button on the Remote Control by the tip of the pencil. "00" will be shown on the display (Picture ①)
4. Press [MODE] during pushing [CHECK]. "B" will show on the display and "00" will disappear and the air conditioner will turn OFF. The Remote Control B is memorized [Picture ②].

- NOTE :**
1. Repeat above step to reset Remote Control to be A.
 2. Remote Control A has not "A" display.
 3. Default setting of Remote Control from factory is A.

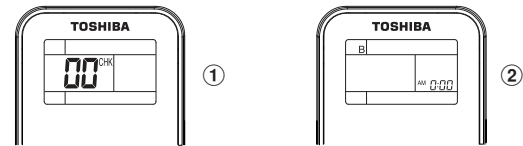

Fig. 10-5-2

10-5-3. Test operation

To switch the TEST RUN (COOL) mode, press RESET button for 10 sec.

(The beeper will make a short beep.)

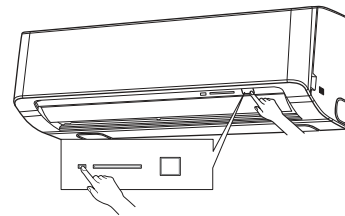

Fig. 10-5-3

10-5-4. Auto restart setting

This product is designed so that, after a power failure, it can restart automatically in the same operating mode as before the power failure.

The product was shipped with Auto Restart function in the off position. Turn it on as required.

<How to set the auto restart>

1. Press and hold the [RESET] button on the indoor unit 3 seconds to set the operation. (3 beep sound and OPERATION lamp blink 5 time/sec for 5 seconds)
2. Press and hold the [RESET] button on the indoor unit for 3 seconds to cancel the operation. (3 beep sound but OPERATION lamp does not blink)
 - In case of ON timer or OFF timer are set, AUTO RESTART OPERATION dose not activate.

11. HOW TO DIAGNOSE THE TROUBLE

The pulse motor circuits are mounted to both indoor and outdoor units. Therefore, diagnose troubles according to the trouble diagnosis procedure as described below. (Refer to the check points in servicing written on the wiring diagrams attached to the indoor/outdoor units.)

Table 11-1

No.	Troubleshooting Procedure	No.	Troubleshooting Procedure
1	First Confirmation	6	How to Check Simply the Main Parts
2	Primary Judgment	7	Troubleshooting
3	Judgment by Flashing LED of Indoor Unit	8	How to Diagnose Trouble in Outdoor Unit
4	Self-Diagnosis by Remote Controller	9	How to Check Simply the Main Parts
5	Judgment of Trouble by Every Symptom	10	How to Simply Judge Whether Outdoor Fan Motor is Good or Bad

◆ Precautions when handling the new inverter (3DV Inverter)



The high voltage circuit is incorporated.

Be careful to do the check service, as the electric shock may be caused in case of touching parts on the P.C. board by hand.

The new inverter (3DV inverter) will be incorporated starting with this unit.

(3DV: 3-shunt Discrete Vector control)

◆ The control circuitry has an uninsulated construction.

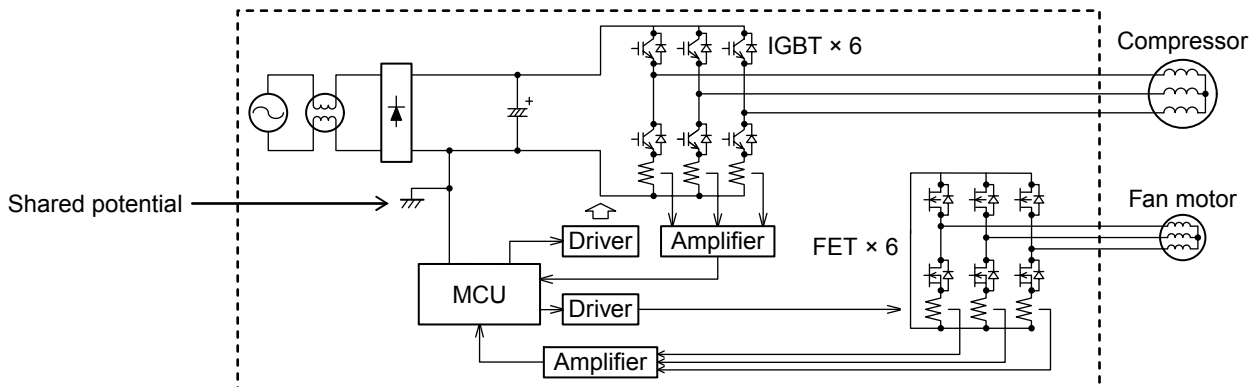

Fig. 11-1



A high voltage (equivalent to the supply voltage) is also energized to ground through the sensors, PMV and other low-voltage circuits. The sensor leads and other wires are covered with insulated tubes for protection. Nevertheless, care must be taken to ensure that these wires are not pinched.

Take sufficient care to avoid directly touching any of the circuit parts without first turning off the power.

At times such as when the circuit board is to be replaced, place the circuit board assembly in a vertical position.

Laying the board flat on an electrically conductive object (such as the top panel of the air conditioner's outdoor unit) while a charge is still retained by the electrolytic capacitors of the inverter's main circuit may cause short-circuiting between the electrolytic capacitors and secondary circuit components and result in damage to the components.

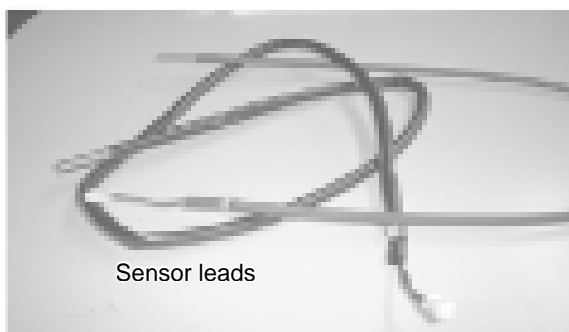

Sensor leads

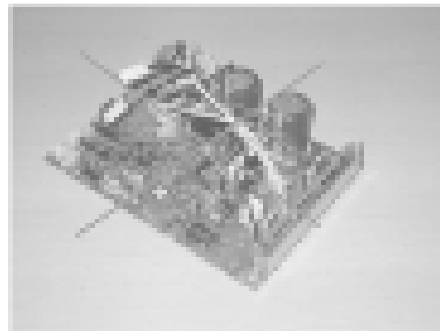

Fig. 11-2

Do NOT lay the circuit board assembly flat.

◆ Precautions when inspecting the control section of the outdoor unit

NOTE :

A large-capacity electrolytic capacitor is used in the outdoor unit controller (inverter). Therefore, if the power supply is turned off, charge (charging voltage DC280 to 380V) remains and discharging takes a lot of time. After turning off the power source, if touching the charging section before discharging, an electrical shock may be caused. Discharge the electrolytic capacitor completely by using soldering iron, etc.

< Discharging method >

1. Remove the inverter cover (plating) by opening four mounting claws.
2. As shown below, connect the discharge resistance (approx. $100\Omega/40W$) or plug of the soldering iron to voltage between + – terminals of the C14 ("CAUTION HIGH VOLTAGE" is indicated.) electrolytic capacitor (500 μ F/400V or 760 μ F/400V) on P.C. board, and then perform discharging.

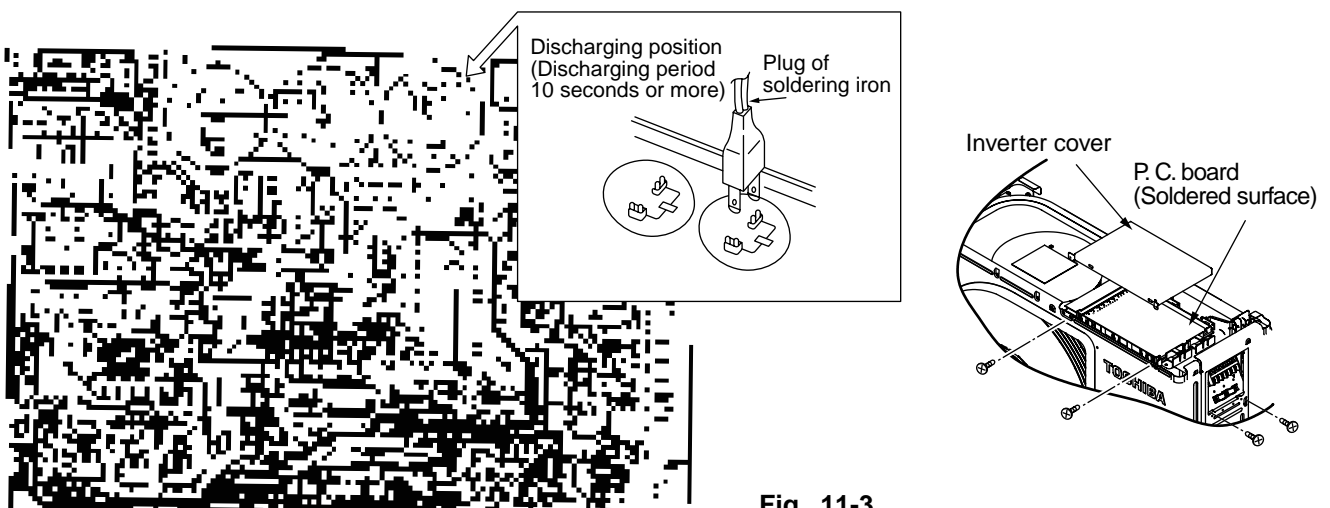

Fig. 11-3

11-1. First Confirmation

11-1-1. Confirmation of Power Supply

Confirm that the power breaker operates (ON) normally.

11-1-2. Confirmation of Power Voltage

Confirm that power voltage is AC 220–230–240 ± 10%.

If power voltage is not in this range, the unit may not operate normally.

11-1-3. Operation Which is not a Trouble (Program Operation)

For controlling the air conditioner, the program operations are built in the microcomputer as described in the following table.

If a claim is made for running operation, check whether or not it meets to the contents in the following table.

When it does, we inform you that it is not trouble of equipment, but it is indispensable for controlling and maintaining of air conditioner.

Table 11-1-1

No.	Operation of air conditioner	Description
1	When power breaker is turned "ON", the operation indicator (Green) of the indoor unit flashes.	The OPERATION lamp of the indoor unit flashes when power source is turned on. If [⏻] button is operated once, flashing stops. (Flashes also in power failure)
2	Compressor may not operate even if the room temperature is within range of compressor-ON.	The compressor does not operate while compressor restart delay timer (3-minutes timer) operates. The same phenomenon is found after power source has been turned on because 3-minutes timer operates.
3	In Dry and ECO mode, FAN (air flow) display does not change even though FAN (air flow select) button is operated.	The air flow indication is fixed to [AUTO].
4	Increasing of compressor motor speed stops approx. 30 seconds after operation started, and then compressor motor speed increases again approx. 30 seconds after.	For smooth operation of the compressor, the compressor motor speed is restricted to Max. 41 rps for 2 minutes, and Max.91 rps for 2 minutes to 3 minutes, respectively after the operation has started.
5	In AUTO mode, the operation mode is changed.	After selecting Cool or Heat mode, select an operation mode again if the compressor keeps stop status for 15 minutes.
6	In HEAT mode, the compressor motor speed does not increase up to the maximum speed or decreases before the temperature arrives at the set temperature.	The compressor motor speed may decrease by high-temp. release control (Release protective operation by temp.-up of the indoor heat exchanger) or current release control.

11-2. Primary Judgment

To diagnose the troubles, use the following methods.

- 1) Judgment by flashing LED of indoor unit
- 2) Self-diagnosis by service check remote controller
- 3) Judgment of trouble by every symptom

Firstly use the method 1) for diagnosis. Then, use the method 2) or 3) to diagnose the details of troubles.

11-3. Judgment by Flashing LED of Indoor Unit

While the indoor unit monitors the operation status of the air conditioner, if the protective circuit operates, the contents of self-diagnosis are displayed with block on the indoor unit indication section.

Table 11-3-1

	Item	Check code	Block display	Description for self-diagnosis
<div style="border: 1px solid black; padding: 5px; width: fit-content;">Indoor indication lamp flashes.</div> <div style="margin-left: 40px;">↓</div> <div style="border: 1px solid black; padding: 5px; width: fit-content;">Which lamp does flash?</div> <div style="margin-left: 40px;">↓</div> <div style="margin-left: 40px;">→</div>	A	—	OPERATION (Green) Flashing display (1 Hz)	Power failure (when power is ON)
	B	00	OPERATION (Green) Flashing display (5 Hz)	Protective circuit operation for indoor P.C. board
	C	01	OPERATION (Green) TIMER (Yellow) Flashing display (5 Hz)	Protective circuit operation for connecting cable and serial signal system
	D	02	OPERATION (Green) FILTER (Orange) Flashing display (5 Hz)	Protective circuit operation for outdoor P.C. board
	E	03	OPERATION (Green) TIMER (Yellow) FILTER (Orange) Flashing display (5 Hz)	Protective circuit operation for others (including compressor)

NOTES :

1. The contents of items B and C and a part of item E are displayed when air conditioner operates.
2. When item B and C, and item B and a part of item E occur concurrently, priority is given to the block of item B.
3. The check codes can be confirmed on the remote controller for servicing.

11-4. Self-Diagnosis by Remote Controller (Check Code)

1. If the lamps are indicated as shown B to E in Table 11-3-1, execute the self-diagnosis by the remote controller.
2. When the remote controller is set to the service mode, the indoor controller diagnoses the operation condition and indicates the information of the self-diagnosis on the display of the remote controller with the check codes. If a fault is detected, all lamps on the indoor unit will flash at 5Hz and it will beep for 10 seconds (Beep, Beep, Beep ...). The timer lamp usually flashes (5Hz) during self-diagnosis.

11-4-1. How to Use Remote Controller in Service Mode

1 Press [CHECK] button with a tip of pencil to set the remote controller to the service mode.

- "00" is indicated on the display of the remote controller.

2 Press [ON ▲] or [OFF ▲] button

If there is no fault with a code, the indoor unit will beep once (Beep) and the display of the remote controller will change as follows :

→ 00 → 01 → 02 ... 1d → 1E → 33 →

- The TIMER indicator of the indoor unit flashes continuously. (5 times per 1 sec.)
- Check the unit with all 52 check codes (00 to 33) as shown in Table-11-4-1.
- Press [ON▼] or [OFF ▼] button to change the check code backward.

If there is a fault, the indoor unit will beep for 10 seconds (Beep, Beep, Beep...).

Note the check code on the display of the remote controller.

- 2-digits alphanumeric will be indicated on the display.
- All indicators on the indoor unit will flash. (5 times per 1 sec.)

3 Press [CLR] button. After service finish for clear service code in memory.

- "7F" is indicated on the display of the remote control.

4 Press [⏻] button to release the service mode.

- The display of the remote controller returns to as it was before service mode was engaged.

Alphanumeric characters are used for the check codes.

5 is 5.	6 is 6.
A is A.	B is B.
C is C.	D is D.

Fig. 11-4-1

11-4-2. Caution at Servicing

1. After servicing, press the [ϕ] button to return to the normal mode.
2. After servicing by the check code, turn off breaker of the power supply, and turn on breaker of the power supply again so that memory in the microcomputer returns the initial status.
However, the check codes are not deleted even if the power supply is turned off because they are stored in the fixed memory.
3. After servicing, press [CLR] button under check mode status and then send the check code "7F" to the indoor unit. The error code stored in memory is cleared.

Table 11-4-1

Block distinction		Operation of diagnosis function				Judgment and action
Check code	Block	Check code	Cause of operation	Air conditioner status	Remarks	
00	Indoor P.C. board etc.	01	Short-circuit or disconnection of the room temperature sensor (TA sensor).	Operation continues.	Displayed when error is detected.	1. Check the room temp. sensor. 2. When the room temp. sensor is normal, check P.C. board.
		02	Being out of place, disconnection, short-circuit, or migration of heat exchanger sensor (TC sensor)	Operation continues.	Displayed when error is detected.	1. Check heat exchanger sensor. 2. When heat exchanger sensor is normal, check P.C. board.
		11	Lock of indoor fan or trouble on the indoor fan circuit	All off	Displayed when error is detected.	1. Check the motor. 2. When the motor is normal, check P.C. board.
	Not displayed	12	Trouble on other indoor P.C. boards	Operation continues.	Displayed when error is detected.	Replace P.C. board.
01	Connecting cable and serial signal	04	Return serial signal is not sent to indoor side from operation started. 1) Defective wiring of connecting cable 2) Operation of compressor thermo Gas shortage Gas leak	Operation continues.	Flashes when trouble is detected on Return serial signal, and normal status when signal is reset.	1. When the outdoor unit never operate: 1) Check connecting cable, and correct if defective wiring. 2) Check 25A fuse of inverter P.C. board. 3) Check 3.15A of inverter P.C. board. 2. To display [Other] block during operation, check compressor thermo. operation and supply gas (check gas leak also). 3. Unit operates normally during check. If return serial signal does not stop between indoor terminal 2 and 3, replace inverter P.C. board. If signal stops between indoor terminal 2 and 3, replace indoor P.C. board.

Block distinction		Operation of diagnosis function				Judgment and action
Check code	Block	Check code	Cause of operation	Air conditioner status	Remarks	
02	Outdoor P.C. board	14	Inverter over-current protective circuit operates. (Short time)	All off	Displayed when error is detected.	Even if trying operation again, all operations stop immediately. : Replace P.C. board.
		15	Position-detect circuit error or short-circuit between windings of compressor	All off	Displayed when error is detected.	1. Even if connecting lead wire of compressor is removed, position-detect circuit error occurred. : Replace P.C. board. 2. Measure resistance between wires of compressor, and perform short-circuit. : Replace compressor.
		17	Current-detect circuit error	All off	Displayed when error is detected.	Even if trying operation again, all operations stop immediately. : Replace P.C. board.
		18	Being out of place, disconnection or short-circuit of the outdoor heat exchanger sensor (TE) or suction temp. sensor (Ts)	All off	Displayed when error is detected.	1. Check sensors (TE, TS). 2. Check P.C. board.
		19	Disconnection or short-circuit of discharge temp. sensor	All off	Displayed when error is detected.	1. Check discharge temp. sensor (TD). 2. Check P.C. board
		1A	Outdoor fan drive system error	All off	Displayed when error is detected.	Position-detect error, over-current protective operation of outdoor fan drive system, fan lock, etc. : Replace P.C. board or fan motor.
	Not displayed	16	Outdoor heat exchanger temp. sensor error	Operation continues	—	1. Check outdoor temp. sensor (TO). 2. Check P.C. board.
Outdoor P.C. board	1C	Compressor drive output error, Compressor error (lock, missing, etc.), Break down	All off	Displayed when error is detected.	When 20 seconds passed after start-up, position-detect circuit error occurred. : Replace compressor. Trouble on P.M.V.	
03	Others (including compressor)	07	Return serial signal has been sent when operation started, but it is not sent from halfway. 1) Compressor thermo. operation Gas shortage Gas leak 2) Instantaneous power failure	Operation continues	Flashes when trouble is detected on return serial signal, and normal status when signal is reset.	1. Repeat Start and Stop with interval of approx. 10 to 40 minutes. (Code is not displayed during operation.) Supply gas. (Check also gas leak). 2. Unit operates normally during check. If return serial signal does not stop between indoor terminal block 2 and 3, replace inverter P.C. board. If signal stops between indoor terminal block 2 and 3, replace indoor P.C. board.
		1D	Compressor does not rotate. (Current protective circuit does not operate when a specified time passed after compressor had been activated.)	All off	Displayed when error is detected.	1. Trouble on compressor 2. Trouble on wiring of compressor (Missed phase)
		1E	Discharge temp. exceeded 117°C	All off	Displayed when error is detected.	1. Check discharge temp. sensor (TD). 2. Gas leakage 3. Trouble on P.M.V.
		1F	Break down of compressor	All off	Displayed when error is detected.	1. Check power voltage. (220–230–240 V +10%) 2. Overload operation of refrigeration cycle Check installation condition (Short-circuit of outdoor diffuser).
		08	4-way valve inverse error (TC sensor value lowered during heating operation.)	Operation continues	—	1. Check 4-way valve operation.

(3) Only the indoor motor fan does not operate

<Primary check>

1. Is it possible to detect the power supply voltage (AC220–240V) between ① and ② on the terminal block?
2. Does the indoor fan motor operate in cooling operation?
(In heating operation, the indoor fan motor does not operate for approximately 10 minutes after it is turned on, to prevent a cold air from blowing in.)

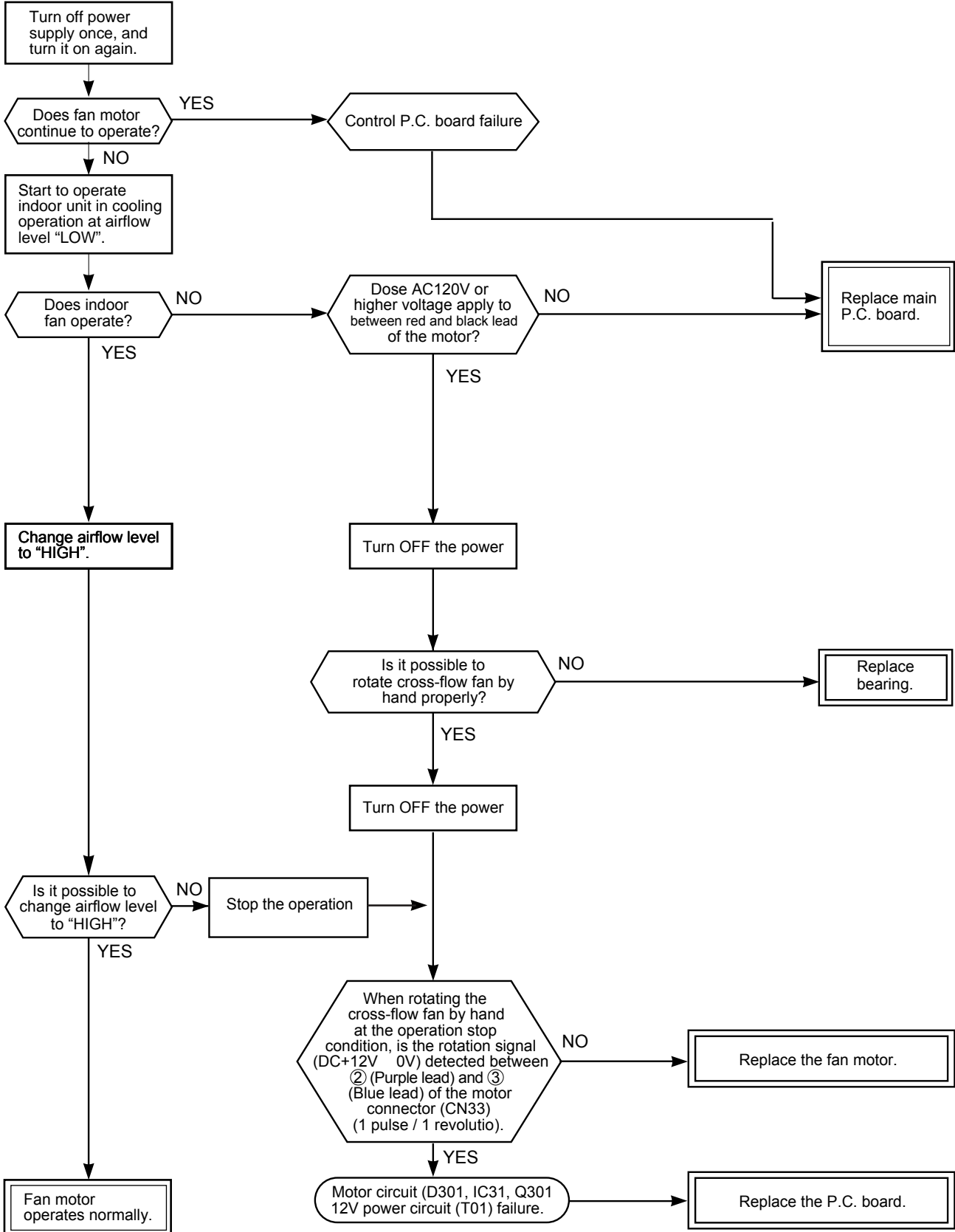

(4) Indoor fan motor automatically starts to rotate by turning on power supply

<Inspection procedure>

1. Remove the front panel. (Remove 2 screws.)
2. Remove the cover of the fan motor lead wires.
3. Check AC voltage with CN31 connector while the fan motor is rotating.

NOTE :

- Using a tester, measure the resistance value of each winding coil.
- Use a thin test rod.

AFN-220-20-4D

- Do not disconnect the connector while the fan motor is rotating.
- For P.C. board side, proceed to the item "Only indoor fan does not operate" of "Judgment of Trouble by Every Symptom".

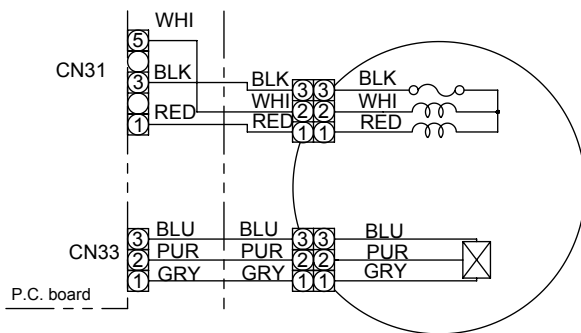

Position (P.C. board)	Resistance value
Between ③ (Black) - ① (Red)	249 ± 18 Ω
Between ③ (Black) - ⑤ (White)	373.3 ± 20 Ω
Between ① (Red) - ⑤ (White)	623 ± 44 Ω

(5) Troubleshooting for remote control

<Primary check>

Check that A or B selected on the main unit is matched with A or B selected on the remote controller.

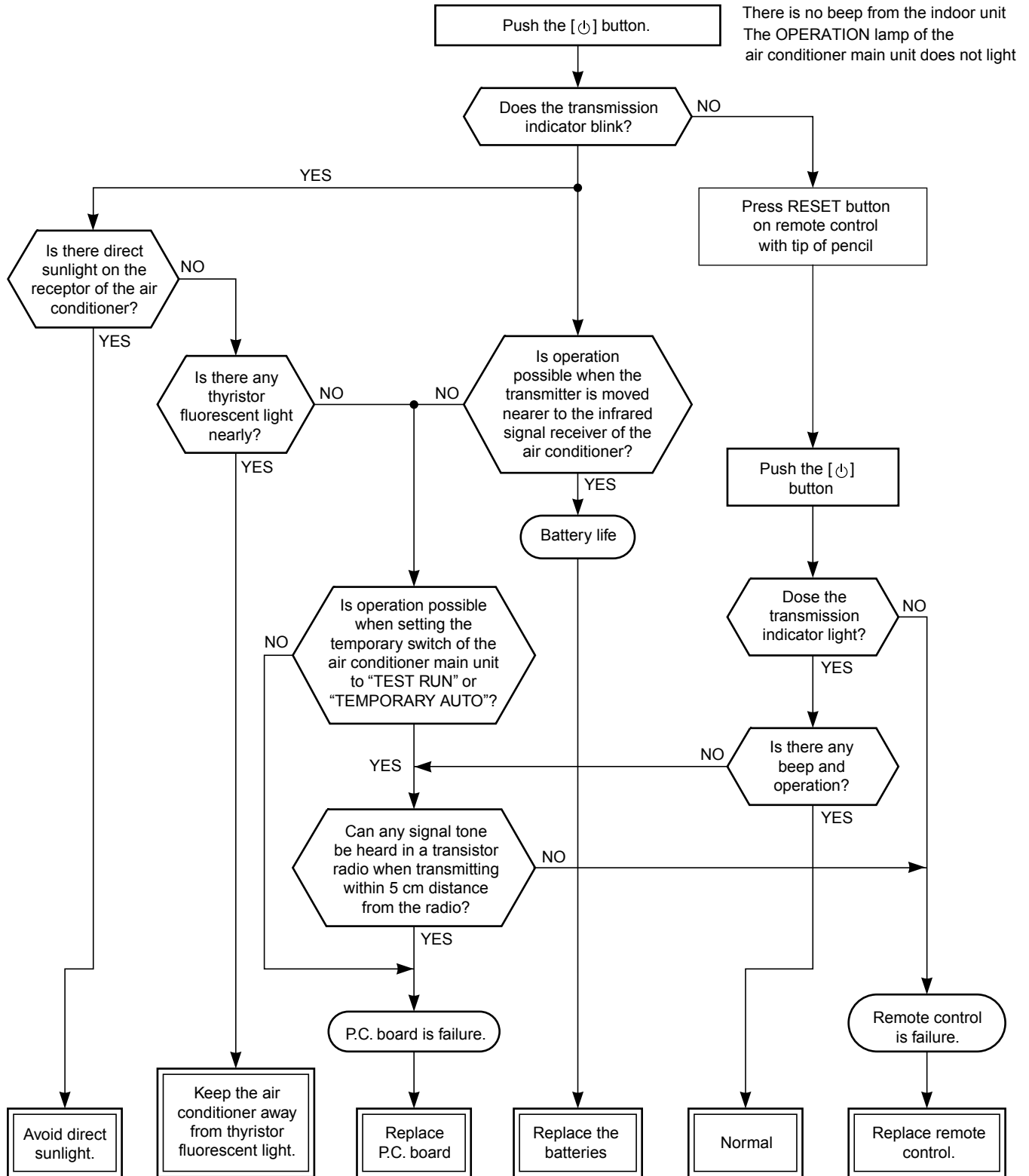

11-5-2. Wiring Failure (Interconnecting and Serial Signal Wire)

(1) Outdoor unit does not operate

1) Is the voltage between ② and ③ of the indoor terminal block varied?

Confirm that transmission from indoor unit to outdoor unit is correctly performed based upon the following diagram.

NOTE:

- Measurement should be performed 2 minutes and 30 seconds after starting of the operation.
- Be sure to prepare a diode for judgment.

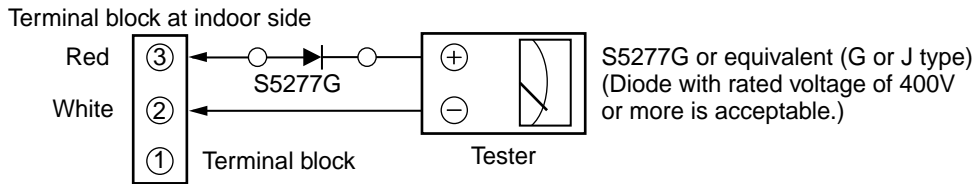

Normal time : Voltage swings between DC15 and 60V.Inverter Assembly check (11-5-1.)

Abnormal time : Voltage does not vary.

(2) Outdoor unit stops in a little while after operation started

<Check procedure> Select phenomena described below.

1) The outdoor unit stops 10 to 20 minutes after operation started, and 10 minutes or more are required to restart the unit.

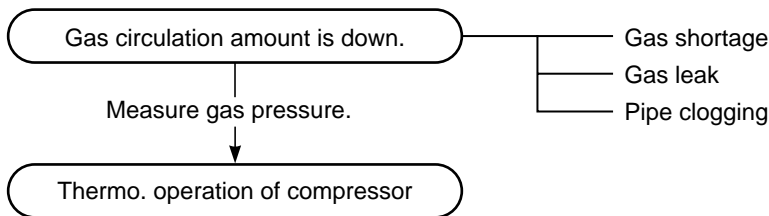

2) If the unit stops once, it does not operate until the power will be turned on again.

To item of Outdoor unit does not operate.

3) The outdoor unit stops 10 minutes to 1 hour after operation started, and an alarm is displayed. (Discharge temp. error check code 03, 1E Sensor temp. error check code 02, 1C)

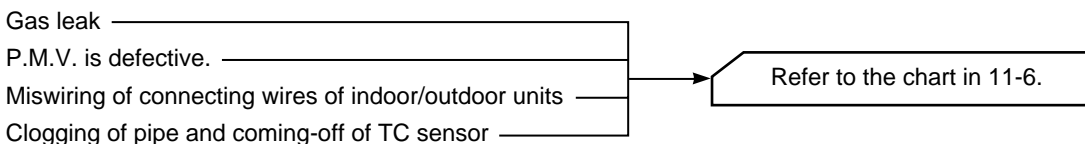

11-6. How to Check Simple the Main Parts

<Check procedure>

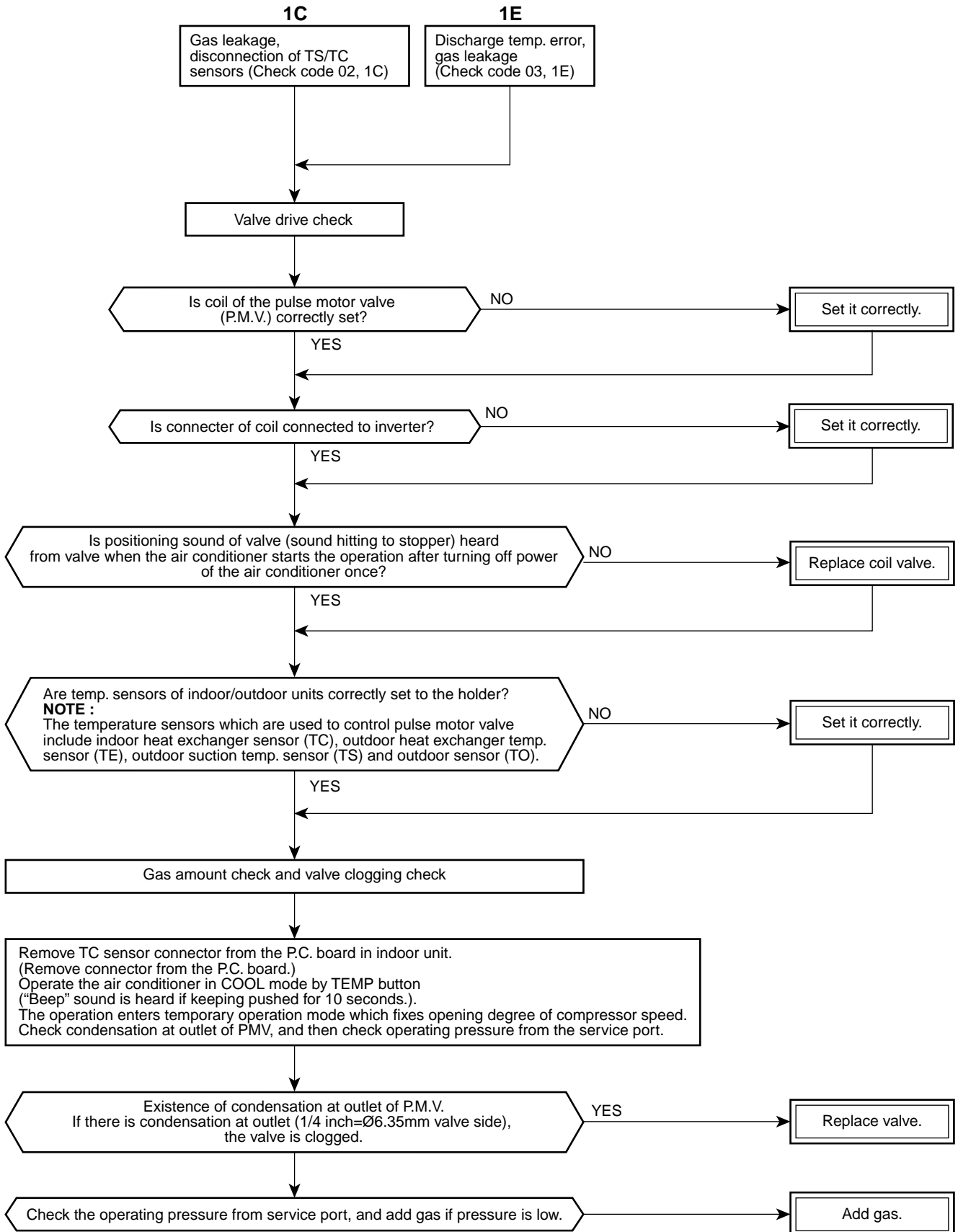

11-7. How to Diagnose Trouble in Outdoor Unit

11-7-1. Summarized Inner Diagnosis of Inverter Assembly

Table 11-7-1

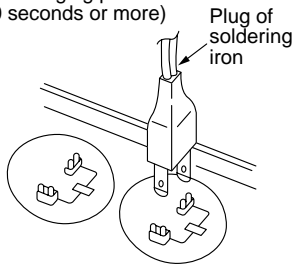
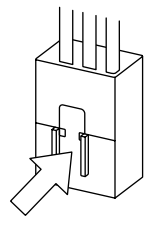
Diagnosis/Process flowchart	Item	Contents	Summary		
<pre> graph TD Start([Remove connector of compressor.]) --> CheckFuse{{Check 25A fuse (Part No.F01).}} CheckFuse -- NG --> ReplaceFuse[Replace fuse.] ReplaceFuse --> CheckDB01{{Check electrolytic capacitor, diode block (DB01), etc.}} CheckFuse -- OK --> CheckVoltage{{Check terminal voltage of electrolytic capacitor.}} CheckDB01 -.-> CheckVoltage CheckVoltage -- NG --> CheckDB01_2{{Check electrolytic capacitor, diode (DB01), etc.}} CheckDB01_2 -.-> CheckVoltage CheckVoltage -- OK --> FanRotate{{Does outdoor fan rotate?}} FanRotate -- YES --> A((A)) FanRotate -- NO --> CheckCN300{{Remove connector CN300 of outdoor fan motor, and using a tester, check resistance value between every phases at motor side.}} CheckCN300 -- NG --> ReplaceMotor[Replace outdoor fan motor.] CheckCN300 -- OK --> B((B)) </pre>	<p>Preparation</p> <p>Check</p> <p>Check</p> <p>Operation</p> <p>Measurement</p> <p>Check</p> <p>Stop</p> <p>Check Measurement</p>	<p>Turn "OFF" the power supply breaker, and remove 3P connector which connects inverter and compressor.</p> <ul style="list-style-type: none"> Check whether 25A fuse on the control board assembly is blown or not. (F01) <p>Turn on the power breaker, and operate the air conditioner in COOL mode by time shortening.</p> <p>Measure terminal voltage of the electrolytic capacity.</p> <table border="1" data-bbox="829 1545 1061 1624"> <tr> <td>500μF:400WV x 3</td> </tr> <tr> <td>760μF:400WV x 3</td> </tr> </table> <p>After operation, turn off the power breaker after 2 minutes 20 seconds passed, and discharge the electrolytic capacitor by soldering iron. Check voltage between motor phases.</p> <ul style="list-style-type: none"> Is not winding between ①-②, ②-③, or ①-③ opened or short-circuited? Is not frame grounded with ①, ②, or ③? 	500μF:400WV x 3	760μF:400WV x 3	<p>If fuse was blown, be sure to check the electrolytic capacitor and diode block. (DB01)</p> <ul style="list-style-type: none"> Connect discharge resistance (approx. 100Ω, 40W) or soldering iron (plug) between +, - terminals of the electrolytic capacitor (500μF or 760μF) of C14 (with printed CAUTION HIGH VOLTAGE) on P.C. board. <p>Discharging position (Discharging period 10 seconds or more)</p>  <p>OK if 500μF or 760μF → DC280 to 380V</p> <p>Remove CN300 while pushing the part indicated by an arrow because CN300 is a connector with lock.</p>  <p>→ Resistance between phases should be approx. 55 to 77Ω</p> <p>→ Should be 10MΩ or more.</p>
500μF:400WV x 3					
760μF:400WV x 3					

(3) Check procedures**Table 11-8-1**

No.	Procedure	Check points	Causes
1	Turn off the power supply breaker and remove the P.C. board assembly from electronic parts base. Remove the connecting cables from the terminal block.	Check whether or not the fuse (F01) is blown.	Impulse voltage was applied or the indoor fan motor short-circuited.
2	Remove the connector of the motor and turn on the power supply breaker. If OPERATION indicator flashes (once per second), it is not necessary to check steps (1 to 3) in the right next column.	Check power supply voltage : 1. Between No. 1 and No. 3 of CN01 (AC 220–240V) 2. Between ⊕ and ⊖ of C27 (DC 310–340V) 3. Between 12V and GND 4. Between 5V and GND	1. The terminal block or the crossover cable is connected wrongly. 2. The capacitor (C01), line filter (L01), resistor (R64), or the diode (DB01) is defective. 3. T01 is defective. 4. IC02 and T01 are defective.
3	Push [⏻] button once to start the unit. (Do not set the mode to On-Timer operation.)	Check power supply voltage : 1. Between CN51 and No. 1 of CN01 (DC 15–60V)	IC51 and IC52 are defective.
4	Shorten the restart delay timer and start unit.	Check whether or not all indicators (OPERATION, TIMER) are lit for 3 seconds and they return to normal 3 seconds later.	The indicators are defective or the housing assembly (CN20) is defective.
5	Push [⏻] button once to start the unit. • Shorten the restart delay timer. • Set the operation mode to COOL. • Set the fan speed level to AUTO. • Set the preset temperature much lower than the room temperature. (The unit (compressor) operates continuously in the above condition.)	1. Check whether or not the compressor operates. 2. Check whether or not the OPERATION indicator flashes.	1. The temperature of the indoor heat exchanger is extremely low. 2. The connection of the heat exchanger sensor is loose. (The connector is disconnected.) (CN62) 3. The heat exchanger sensor and the P.C. board are defective. (Refer to Table 11-4-1.) 4. The main P.C. board is defective.
6	If the above condition (No. 5) still continues, start the unit in the following condition. • Set the operation mode to HEAT. • Set the preset temperature much higher than room temperature.	1. Check whether or not the compressor operates. 2. Check whether or not the OPERATION indicator flashes.	1. The temperature of the indoor heat exchanger is extremely high. 2. The connection of the heat exchanger sensor short-circuited. (CN62) 3. The heat exchanger sensor and the P.C. board are defective. (Refer to Table 11-4-1.) 4. The main P.C. board is defective
7	Connect the motor connector to the motor and turn on the power supply. Start the unit the following condition. • Set the fan speed level to HIGH. (The unit (compressor) operates continuously in the above condition in No. 5.)	1. Check it is impossible to detect the voltage (AC120V or higher voltage) between red and black lead of the motor. 2. The motor does not operate or the fan motor does not rotate with high speed. (But it is possible to receive the signal from the remote controller.) 3. The motor rotates but vibrates strongly.	1. The indoor fan motor is defective. (Protected operation of P.C. board.) 2. The P.C. board is defective. 3. The connection of the motor connector is loose.

11-8-2. P.C . Board Layout

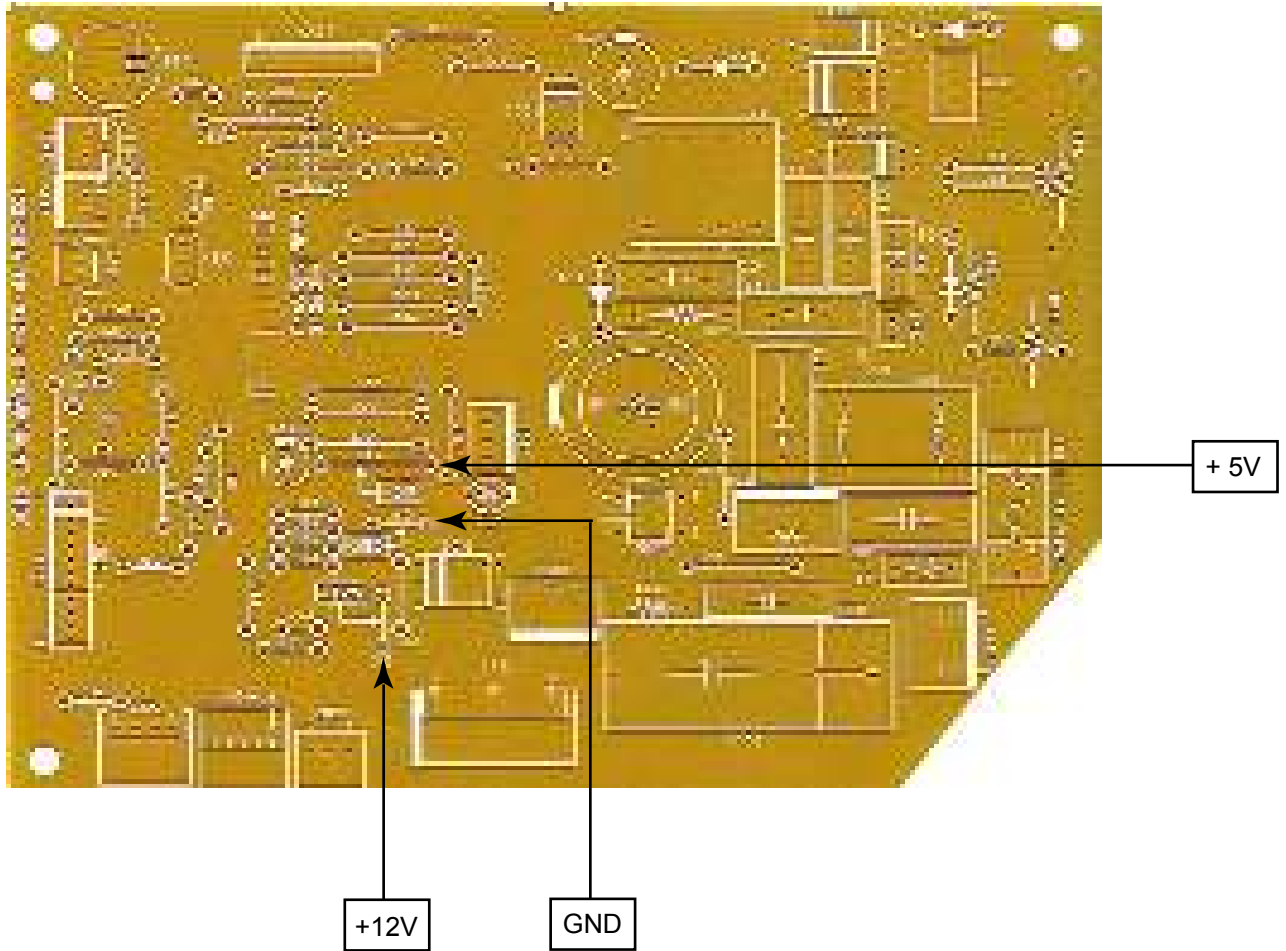

[1] Sensor characteristic table

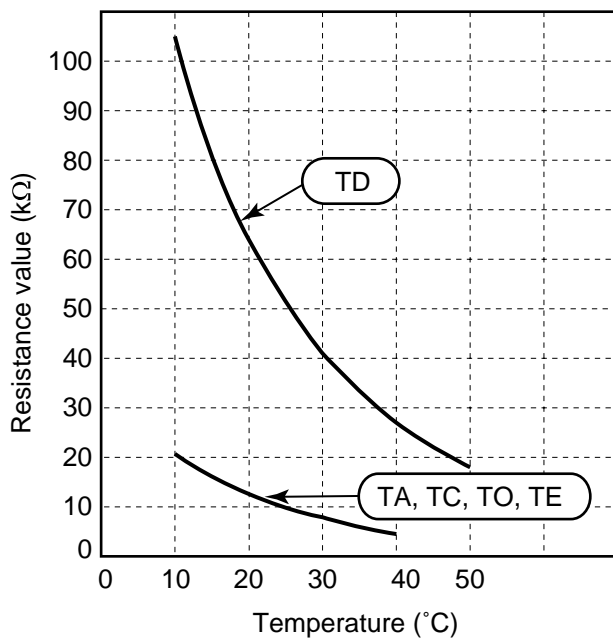

- TD : Discharge temp. sensor
- TA : Room temp. sensor
- TC : Heat exchanger temp. sensor
- TO : Outdoor temp. sensor
- TE : Outdoor heat exchange temp. sensor

11-8-3. Indoor unit (Other parts)

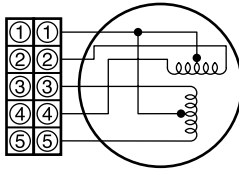
No.	Part name	Checking procedure																		
1	Room temp. (TA) sensor Heat exchanger (TC) sensor	<p>Disconnect the connector and measure the resistance value with tester. (Normal temp.)</p> <table border="1"> <thead> <tr> <th>Temperature</th> <th>10°C</th> <th>20°C</th> <th>25°C</th> <th>30°C</th> <th>40°C</th> </tr> </thead> <tbody> <tr> <td>Sensor</td> <td></td> <td></td> <td></td> <td></td> <td></td> </tr> <tr> <td>TA, TC (kΩ)</td> <td>20.7</td> <td>12.6</td> <td>10.0</td> <td>7.9</td> <td>4.5</td> </tr> </tbody> </table>	Temperature	10°C	20°C	25°C	30°C	40°C	Sensor						TA, TC (kΩ)	20.7	12.6	10.0	7.9	4.5
Temperature	10°C	20°C	25°C	30°C	40°C															
Sensor																				
TA, TC (kΩ)	20.7	12.6	10.0	7.9	4.5															
2	Remote control	Refer to 11-5-1 (5)																		
3	Louver motor MP24ZCT	<p>Measure the resistance value of each winding coil by using the tester. (Under normal temp. 25°C)</p> <div style="display: flex; align-items: center;"> <div style="margin-right: 20px;"> <p>White ①①</p> <p>Yellow ②②</p> <p>Yellow ③③</p> <p>Yellow ④④</p> <p>Yellow ⑤⑤</p> </div>  <table border="1" style="margin-left: 20px;"> <thead> <tr> <th>Position</th> <th>Resistance value</th> </tr> </thead> <tbody> <tr> <td>1 to 2</td> <td rowspan="5" style="text-align: center; vertical-align: middle;">250±20Ω</td> </tr> <tr> <td>1 to 3</td> </tr> <tr> <td>1 to 4</td> </tr> <tr> <td>1 to 5</td> </tr> <tr> <td>1 to 5</td> </tr> </tbody> </table> </div>	Position	Resistance value	1 to 2	250±20Ω	1 to 3	1 to 4	1 to 5	1 to 5										
Position	Resistance value																			
1 to 2	250±20Ω																			
1 to 3																				
1 to 4																				
1 to 5																				
1 to 5																				
4	Indoor fan motor	Refer to 11-5-1 (3) and (4).																		

11-8-4. Outdoor unit

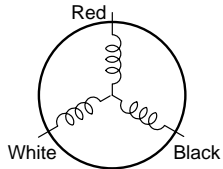
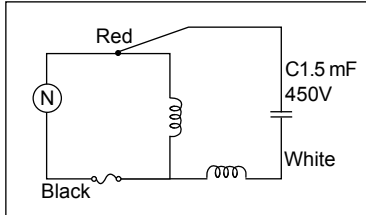
No.	Part name	Checking procedure																		
1	Compressor (Model : DA89X1C-23EZ)	<p>Measure the resistance value of each winding by using the tester.</p> <div style="display: flex; align-items: center;">  <table border="1" style="margin-left: 20px;"> <thead> <tr> <th>Position</th> <th>Resistance value</th> </tr> </thead> <tbody> <tr> <td>Red - White</td> <td rowspan="3" style="text-align: center; vertical-align: middle;">1.1Ω</td> </tr> <tr> <td>White - Black</td> </tr> <tr> <td>Black - Red</td> </tr> </tbody> </table> <p style="text-align: right; margin-right: 20px;">Under 20°C</p> </div>	Position	Resistance value	Red - White	1.1Ω	White - Black	Black - Red												
Position	Resistance value																			
Red - White	1.1Ω																			
White - Black																				
Black - Red																				
2	Outdoor fan motor (Model : WLF-240-20A-1)	<p>Measure the resistance value of winding by using the tester.</p> <div style="display: flex; align-items: center;">  <table border="1" style="margin-left: 20px;"> <thead> <tr> <th>Position</th> <th>Resistance value</th> </tr> </thead> <tbody> <tr> <td>White - Black</td> <td style="text-align: center;">260.1</td> </tr> <tr> <td>Black - Red</td> <td style="text-align: center;">235.2</td> </tr> </tbody> </table> </div>	Position	Resistance value	White - Black	260.1	Black - Red	235.2												
Position	Resistance value																			
White - Black	260.1																			
Black - Red	235.2																			
3	Outdoor temperature sensor (TO), discharge temperature sensor (TD), suction temperature exchanger temperature sensor (TE)	<p>Disconnect the connector, and measure resistance value with the tester. (Normal temperature)</p> <table border="1"> <thead> <tr> <th>Temperature</th> <th>10°C</th> <th>20°C</th> <th>30°C</th> <th>40°C</th> <th>50°C</th> </tr> </thead> <tbody> <tr> <td>Sensor</td> <td></td> <td></td> <td></td> <td></td> <td></td> </tr> <tr> <td>TA, TC (kΩ)</td> <td>105</td> <td>64</td> <td>41</td> <td>27</td> <td>18</td> </tr> </tbody> </table> <p>TG : Heat pump model only. TO, TS, TE : Refer to the TA, TC characteristic table in Indoor (Refer to Table 11-8-3, No.1).</p>	Temperature	10°C	20°C	30°C	40°C	50°C	Sensor						TA, TC (kΩ)	105	64	41	27	18
Temperature	10°C	20°C	30°C	40°C	50°C															
Sensor																				
TA, TC (kΩ)	105	64	41	27	18															

11-8-5. Checking Method for Each Part

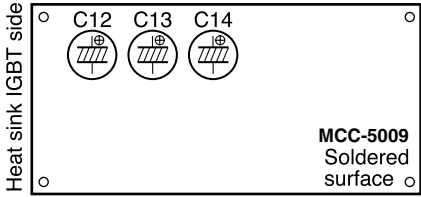
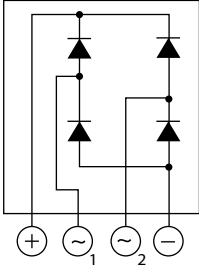
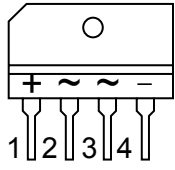
No.	Part name	Checking procedure													
1	Electrolytic capacitor (For raising pressure, smoothing)	<p>1. Turn OFF the power supply breaker. 2. Discharge all three capacitors completely. 3. Check that safety valve at the bottom of capacitor is not broken. 4. Check that vessel is not swollen or exploded. 5. Check that electrolytic liquid does not blow off. 6. Check that the normal charging characteristics are show in continuity test by the tester.</p> <div style="display: flex; justify-content: space-between; align-items: flex-start;"> <div style="border: 1px solid black; padding: 5px; width: 60%;">  </div> <div style="border: 1px solid black; padding: 5px; width: 35%;"> <p>Case that product is good</p> <p>Pointer swings once, and returns slowly. When performing test once again under another polarity, the pointer should return.</p> </div> </div> <p style="text-align: center;">C12, C13, C14 → 500μF or 760μF/400V</p>													
2	Converter module	<p>1. Turn OFF the power supply breaker. 2. Discharge all three capacitors completely. 3. Check that the normal rectification characteristics are shown in continuity test by the tester.</p> <div style="display: flex; justify-content: space-around; align-items: center;"> <div style="text-align: center;">  </div> <div style="text-align: center;">  <p>(DB01)</p> </div> </div> <p style="text-align: center;">Diode check</p> <table border="1" style="margin-left: auto; margin-right: auto;"> <thead> <tr> <th colspan="2">Tester rod</th> <th rowspan="2">Resistance value in good product</th> </tr> </thead> <tbody> <tr> <td>⊕</td> <td>⊖</td> <td rowspan="6" style="text-align: center; vertical-align: middle;">50k or more (0 in trouble)</td> </tr> <tr> <td>⊖₁</td> <td>⊖</td> </tr> <tr> <td>⊖₂</td> <td>⊖</td> </tr> <tr> <td rowspan="2">⊕</td> <td>⊖₁</td> </tr> <tr> <td>⊖₂</td> </tr> </tbody> </table>	Tester rod		Resistance value in good product	⊕	⊖	50k or more (0 in trouble)	⊖ ₁	⊖	⊖ ₂	⊖	⊕	⊖ ₁	⊖ ₂
Tester rod		Resistance value in good product													
⊕	⊖		50k or more (0 in trouble)												
⊖ ₁	⊖														
⊖ ₂	⊖														
⊕	⊖ ₁														
	⊖ ₂														

11-9. How to Simply Judge Whether Outdoor Fan Motor is Good or Bad

1. Symptom

- Outdoor fan motor does not rotate.
 - Outdoor fan motor stops within several tens seconds though it started rotating.
 - Outdoor fan motor rotates or does not rotate according to the position where the fan stopped, etc.
- Remote controller check code “02 : Outdoor block, 1A : Outdoor fan drive system error”

2. Cause

The following causes are considered when the outdoor fan motor does not normally rotate.

- 1) Mechanical lock of the outdoor fan motor
- 2) Winding failure of the outdoor fan motor
- 3) Position-detect circuit failure inside of the outdoor fan motor
- 4) Motor drive circuit failure of the outdoor P.C. board

3. How to simply judge whether outdoor fan motor is good or bad

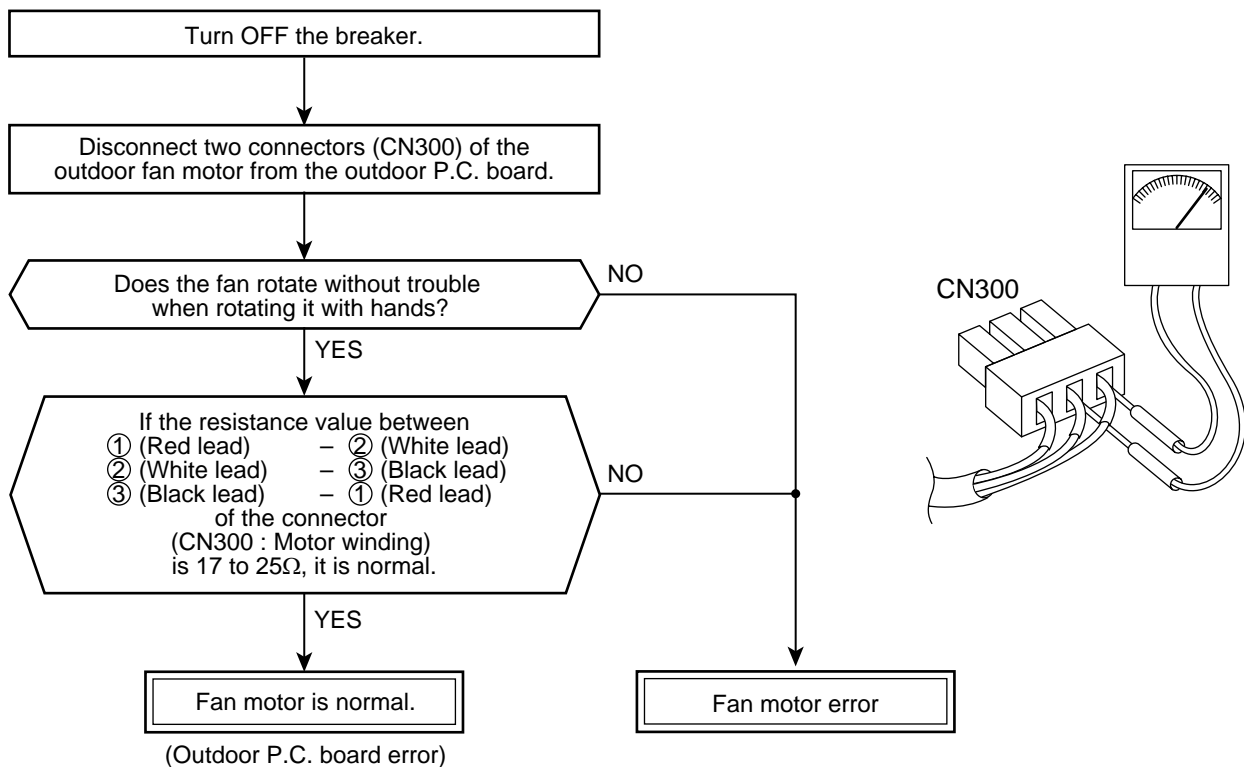



NOTE :

However, GND circuit error inside of the motor may be accepted in some cases when the above check is performed.

When the fan motor does not become normal even if P.C. board is replaced, replace the outdoor fan motor.

12. HOW TO REPLACE THE MAIN PARTS

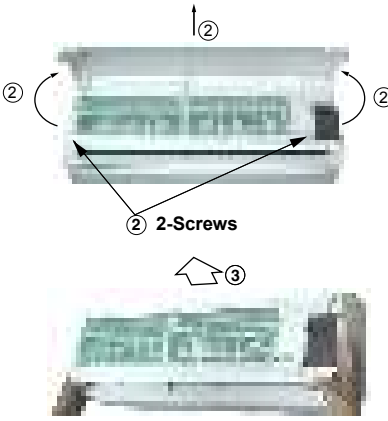
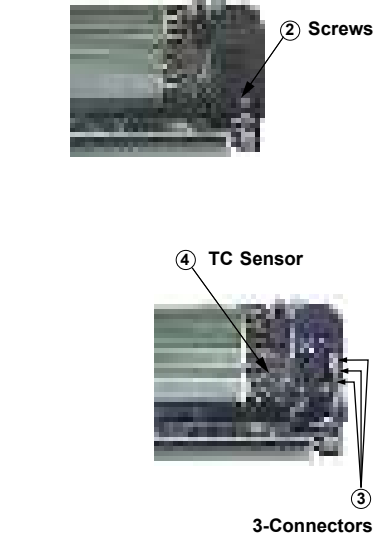
12-1. Indoor Unit

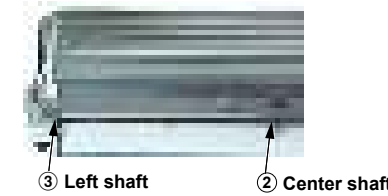
No.	Part name	Procedures	Remarks
①	Front panel	<p>How to remove the front panel</p> <ol style="list-style-type: none"> 1) Stop the operation of the air conditioner and turn off its main power supply. 2) Pull the air inlet grille toward you to open it and remove the air inlet grille. Then remove the 2 screws fixing the front panel. 3) First open the horizontal louver, and then remove the front panel from the back body by pulling it toward you. <p>How to mount the front panel</p> <p>Push the front panel back in and make sure all hooks are locked.</p>	 <p>② 2-Screws</p> <p>③</p>
②	Electrical part	<p>How to remove the electrical part.</p> <ol style="list-style-type: none"> 1) Remove the front panel with procedure 1 . 2) Remove the screw holding the electrical part cover. 3) Disconnect the 3 connectors 2-(3P) for the fan motor and the connector (5P) for the louver motor from the P.C. board assembly. 4) Pull out the TC sensor from the sensor holder. 5) Remove the screw for the ground connection, remove the screw for the electrical part box. Then remove the LED and the electrical part box from the main unit. <p>How to mount the electrical part.</p> <ol style="list-style-type: none"> 1) To put back the electrical part box, lock it to the upper hook of the back body. 2) Tighten the screws on the electrical part box. 3) Connect the 3 connectors and arrange the wiring same as original condition and then tighten the screw from the LED unit to the back body. 4) Attach the TC sensor to the holder. 5) Tighten the screw for the ground connection. 6) Tighten the screw on the electrical part cover. 	 <p>② Screws</p> <p>④ TC Sensor</p> <p>③ 3-Connectors</p>  <p>⑤ Screws</p>
③	Horizontal louver	<ol style="list-style-type: none"> 1) Remove the front panel and the electrical part following procedure ②. 2) Remove the center shaft of the horizontal louver from the back body. 3) Remove the left shaft from the back body. 4) Remove the horizontal louver from the back body. 	 <p>③ Left shaft</p> <p>② Center shaft</p>

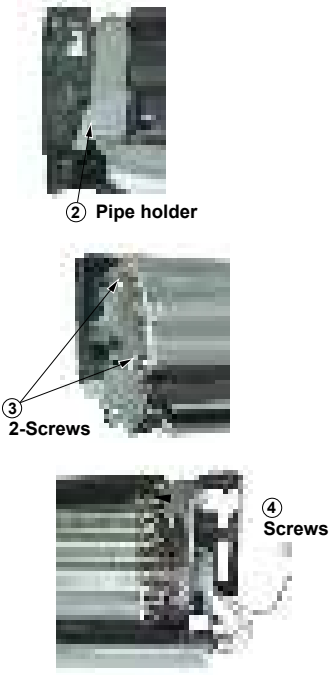
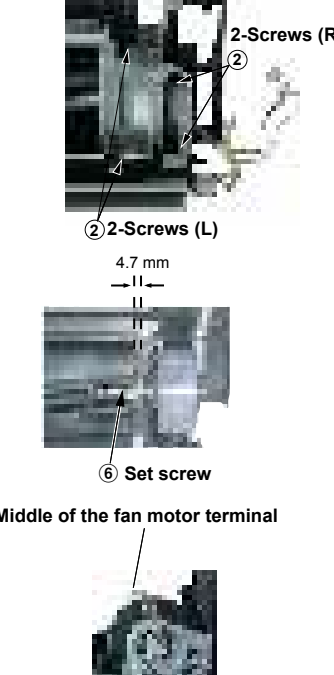
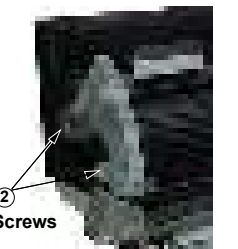
No.	Part name	Procedures	Remarks
④	Heat exchanger	<ol style="list-style-type: none"> 1) Remove the front panel, electrical part and the horizontal louver following procedure ③. 2) Remove the pipe holder at the rear side of main unit. 3) Remove the 2 screws on the heat exchanger at the base bearing. 4) Remove the screw on the heat exchanger at the fixed plate from the back body and then pull out the right hand side until the socket of heat exchanger released from the hook of the band motor (L), and then pull out the upper side of heat exchanger slowly. 	 <p>② Pipe holder</p> <p>③ 2-Screws</p> <p>④ Screws</p>
⑤	Cross flow fan	<ol style="list-style-type: none"> 1) Remove the front panel, electrical part, horizontal louver and the heat exchanger following procedure ④. 2) Remove the 2 screws on the band motor (L) and remove the 2 screws on the band motor (R) and then remove the cross flow fan. 3) Loosen the set screw of the cross flow fan then separate the fan and the fan motor. <p>Notice</p> <p>To assemble cross flow fan and fan motor to the unit, please turn the fan motor until the center of its terminal meets the top position of band motor (R).</p> <p>Fix the cross flow fan with the set screw at the position where the gap between the back body and the right surface of the cross flow fan is 4.7 mm.</p>	 <p>② 2-Screws (R)</p> <p>② 2-Screws (L)</p> <p>4.7 mm</p> <p>⑥ Set screw</p> <p>Middle of the fan motor terminal</p>
⑥	Base bearing	<ol style="list-style-type: none"> 1) Remove the front panel, electrical part, horizontal louver, heat exchanger and the cross flow fan following procedure ⑤. 2) Remove the 2 screws fixing the base bearing. 3) Remove the bearing from the base bearing. If the housing protrudes from the base bearing, put the housing in position and attach the bearing to the base bearing. 	 <p>② 2-Screws</p>

12-2. Microcomputer

No.	Part name	Procedure	Remarks
①	Common procedure	1) Turn the power supply off to stop the operation of air-conditioner. 2) Remove the front panel. • Remove the 2 fixing screws. 3) Remove the electrical part base.	

12-3. Outdoor Unit

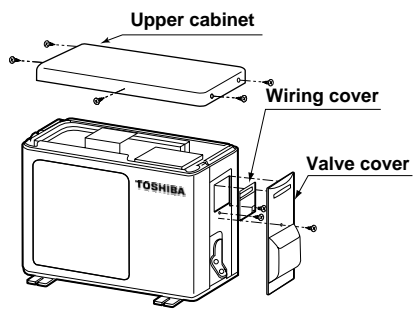
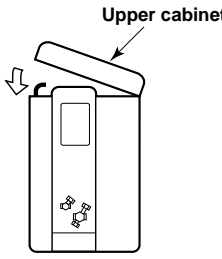
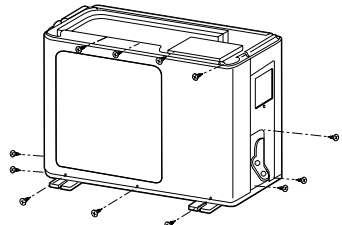
No.	Part name	Procedures	Remarks
①	Common procedure	<p>1. Detachment</p> <ol style="list-style-type: none"> 1) Stop operation of the air conditioner, and turn off the main switch and breaker of the air conditioner. 2) Remove the valve cover. (ST1TØ4 x 10ℓ 1 pc) <ul style="list-style-type: none"> • After removing screw, remove the valve cover pulling it downward. 3) Remove the wiring cover (ST1TØ4 x 10ℓ 2 pcs.), and then remove the power cord, connecting cable, and cord clamp (ST2TØ4 x 16ℓ 3 pcs.). 4) Remove the upper cabinet. (ST1TØ4 x 10ℓ 5 pcs.) <ul style="list-style-type: none"> • After removing screws, remove the upper cabinet pulling it upward. <p>2. Attachment</p> <ol style="list-style-type: none"> 1) Attach the upper cabinet. (ST1TØ4 x 10ℓ 5 pcs.) <ul style="list-style-type: none"> • Hook the rear side of the upper cabinet to the claw of the rear cabinet, and then place it on the front cabinet. 2) After connecting the power cord and connecting cable, attach the cord clamp and wiring cover. <ul style="list-style-type: none"> • Insert the upper part into the upper cabinet, and insert the claw which has been hooked to the lower part into the square hole, and then fix it with screw. (ST1TØ4 x 10ℓ 1 pc.) 3) Attach the valve cover. (ST1TØ4 x 10ℓ 1 pc.) <ul style="list-style-type: none"> • Insert the upper part to the upper cabinet, set the hook claw of the valve cover to square holes (at three positions) of the main unit, and attach it pushing upward. 	 
②	Front cabinet	<p>1. Detachment</p> <ol style="list-style-type: none"> 1) Perform work of item 1 of ①. 2) Remove upper screw (ST1TØ4 x 10ℓ 4 pcs.) of the front cabinet, and lower screws (ST1TØ4 x 10ℓ 8 pcs.) of the front cabinet. <ul style="list-style-type: none"> • Both side of front cabinet envelop the unit, so remove it by pulling sideward. <p>2. Attachment</p> <ol style="list-style-type: none"> 1) Assemble front cabinet to the unit. 2) Attach the removed screws to the original positions. 	

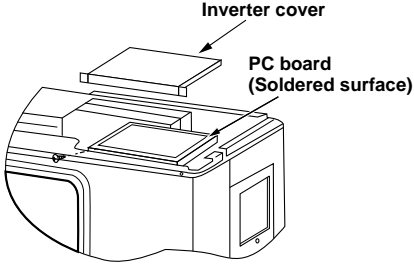
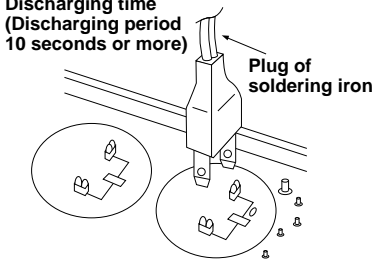
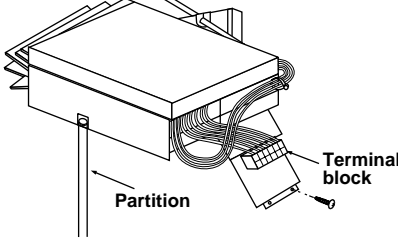
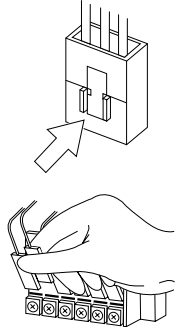
No.	Part name	Procedures	Remarks
③	Inverter assembly	<p>1) Perform work of item 1 of ①.</p> <p>2) Remove screw (ST1TØ4 x 10ℓ 1 pc.) of the upper part of the front cabinet.</p> <ul style="list-style-type: none"> • If removing the inverter cover in this condition, the P.C. board can be checked. • If there is no space in the upper part of the upper cabinet, perform work of ②. <div style="border: 1px solid black; padding: 5px; margin: 10px 0;"> <p>Be careful when checking the inverter because high-voltage circuit is incorporated in it.</p> </div> <p>3) Perform discharging by connecting the ⊕, ⊖ polarities by discharging resistance (approx. 100Ω40W) or plug of soldering iron to ⊕, ⊖ terminals of the C13 (printed "CAUTION HIGH VOLTAGE" is attached.) electrolytic capacitor (760 μF/400 WV) on the P.C. board.</p> <div style="border: 1px solid black; padding: 5px; margin: 10px 0;"> <p>Be careful to discharge the capacitor because the electrolytic capacitor cannot naturally discharge and voltage remains depending on the malfunction state in some cases.</p> </div> <div style="border: 1px solid black; padding: 5px; margin: 10px 0;"> <p>NOTE : This capacitor has mass capacity. Therefore, it is dangerous that a large spark generates if short-circuiting between the ⊕, ⊖ polarities with screwdriver, etc. for discharging.</p> </div> <p>4) Perform the work of ②.</p> <p>5) Remove the screw (ST1TØ4 x 10ℓ 1 pc.) fixing the main body and the inverter box.</p> <p>6) Remove the lead wire from the holder on the terminal block.</p> <p>7) Disconnect the connectors of various lead wires.</p> <div style="border: 1px solid black; padding: 5px; margin: 10px 0;"> <p>Requirement : As each connector has a lock mechanism, avoid removing the connector by holding the lead wire, but by holding the connector.</p> </div>	 <p>Inverter cover PC board (Soldered surface)</p>  <p>Discharging time (Discharging period 10 seconds or more) Plug of soldering iron</p>  <p>Terminal block Partition</p> <p>The connector is one with lock, so remove it while pushing the part indicated by an arrow.</p>  <p>Be sure to remove the connector by holding the connector, not by pulling the lead wire.</p>

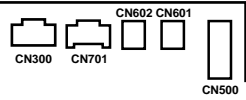
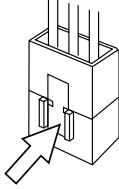
No.	Part name	Procedures	Remarks
④	Control board assembly	<p>1) Disconnect lead wires and connectors connected from the control board assembly to other parts.</p> <p>1. Lead wires</p> <ul style="list-style-type: none"> • Connection with terminal block : 3 wires (Black, White, Orange) • Connection with compressor : remove the connector (3P) • Connection with reactor : remove the connector (2P) <p>2. Connectors (6 positions)</p> <p>CN300, CN703 : Outdoor fan (3P: white)* (See Note 1)</p> <p>CN701 : 4 way valve (3P: Yellow)*</p> <p>CN601 : TD sensor (2P: White)</p> <p>CN602 : TO sensor (2P: White)</p> <p>CN500 : Case thermo (2P: White)</p> <p>* Note 1) As the connector has a stopper, release the housing lock when removing.</p> <p>** Note 2) Hold the housing (resin part) with stopper and pull out to remove.</p> <p>2) Remove the control board assembly from the inverter box.</p> <p>Note 2) Remove the claw of the board support fixed to the inverter board, and remove upwards holding the heat sink.</p> <p>3) Remove the three screws fixing the heat sink and control board assembly.</p> <p>4) Attach the new control board assembly.</p> <p>Note 4) When attaching the new control board assembly, insert the P.C. board into the guide rail groove correctly.</p>	<div style="text-align: right;">  </div> <p>As CN300 and CN701 are connectors with lock, remove while pushing the part indicated by an arrow</p> <div style="text-align: center;">  </div>

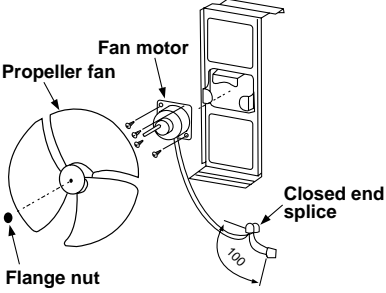
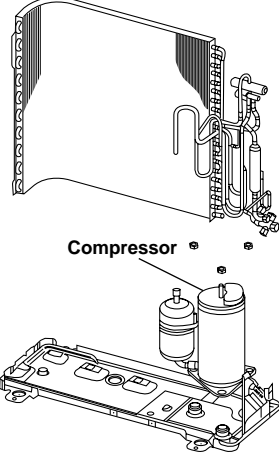
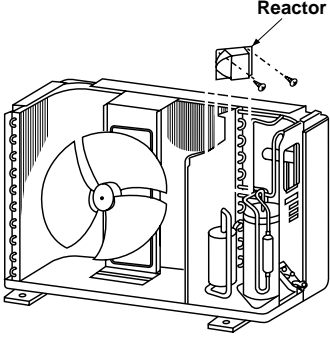
No.	Part name	Procedures	Remarks
n	Fan motor	<ol style="list-style-type: none"> 1) Perform work of item 1 of ① and 1 of ②. 2) Remove the flange nut fixing the fan motor and the propeller fan. <ul style="list-style-type: none"> • Flange nut is loosened by turning clockwise. (To tighten the flange nut, turn counter-clockwise.) 3) Remove the propeller fan. 4) Disconnect the connector for the fan motor from the inverter. 5) Remove the fixing screws (4 pcs.) holding the fan motor by hand so that it does not fall. 6) Cut the motor lead at the point which is 100 mm apart from the connector toward the fan. 7) Use the connector used for the inverter, and pinch the lead wires using the closed end splice. 	
o	Compressor	<ol style="list-style-type: none"> 1) Perform work of item 1 of ①, 1 of ② and ③. 2) Extract refrigerant gas. 3) Remove the partition board. (ST1TØ4 x 10ℓ 3 pcs.) 4) Remove the sound-insulation material. 5) Remove the terminal cover of the compressor, and disconnect the lead wire of the compressor thermo and the compressor from the terminal. 6) Remove the pipe connected to the compressor with a burner. <ul style="list-style-type: none"> • Make sure the flame does not touch the 4 way valve. 7) Remove the fixing screw of the base plate and heat exchanger. (ST1TØ4 x 10ℓ 2 pcs.) 8) Pull upward the refrigeration cycle. 9) Remove the nut fixing the compressor to the base plate. 	
p	Reactor	<ol style="list-style-type: none"> 1) Perform work of item 1 of ①, 1 of ②, and ③. 2) Remove the screw fixing the reactor. (ST1TØ4 x 10ℓ 2 PCS.) 	

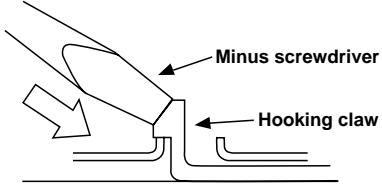
No.	Part name	Procedures	Remarks
q	Fan guard	<p>1. Detachment</p> <p>1) Perform work of item 1 of ① and 1 of ②.</p> <div data-bbox="496 320 999 465" style="border: 1px solid black; padding: 5px; margin: 10px 0;"> <p>Requirement: Perform the work on a corrugated cardboard, cloth, etc. to prevent scratches to the product.</p> </div> <p>2) Remove the front cabinet, and place it down so that the fan guard side faces downwards.</p> <p>3) Remove the hooking claws by pushing a minus screwdriver according to the arrow mark in the right figure, and remove the fan guard.</p> <p>2. Attachment</p> <p>1) Insert the claws of the fan guard in the hole of the front cabinet. Push the hooking claws (8 positions) by your hand and fix the claws.</p> <div data-bbox="496 925 999 1108" style="border: 1px solid black; padding: 5px; margin: 10px 0;"> <p>Requirement: This completes all the attaching work. Check that all the hooking claws are fixed to the specified positions.</p> </div>	 <p>The diagram illustrates the detachment of a hooking claw. A hand is shown using a minus screwdriver to push against the top of a hooking claw. An arrow labeled 'Minus screwdriver' points to the tip of the screwdriver. Another arrow labeled 'Hooking claw' points to the claw being pushed. The claw is shown being lifted away from a surface.</p>

No.	Part name	Procedures	Remarks																												
⑨	<p>Replacement of temperature sensor for servicing only</p> <p>Common service parts of sensor TO, TD</p> <p>These are parts for servicing sensors. Please check that the accessories shown in the right table are packed.</p>	<ol style="list-style-type: none"> 1) Cut the sensor 100 mm longer than old one. 2) Cut the protective tube after pulling out it (200 mm). 3) Move the protective tube toward the thermal sensor side and tear the tip of lead wire in two, then strip the covering part. 4) Pass the stripped part through the thermal constringent tube. 5) Cut the old sensor 100 mm length on the connector side, and recycle that connector. 6) Tear the lead wire in two on the connector side and strip and covering part. 7) Twist the leads on the connector and sensor sides, and solder them. 8) Move the thermal constringent tubes toward the soldered parts and heat them with the dryer and constring them. 9) Wind the attached color tape round the both terminals of the protective tube when colored protective tube is used. 10) Fix the sensor again. <p>NOTES:</p> <ol style="list-style-type: none"> 1) Store the joint part of the sensor and the connector in the electric parts box. 2) Never joint them near the thermal sensor part. Otherwise, it would cause insulation inferiority because of dew drops. 3) When replacing the sensor using the colored protective tube, wind the color tape matching the color of that tube. 																													
		<table border="1"> <thead> <tr> <th></th> <th>Part name</th> <th>Q'ty</th> <th>Remarks</th> </tr> </thead> <tbody> <tr> <td>1</td> <td>Sensor</td> <td>1</td> <td>Length: 3 m</td> </tr> <tr> <td>2</td> <td>Sensor Spring (A)</td> <td>1</td> <td>For spare</td> </tr> <tr> <td>3</td> <td>Sensor Spring (B)</td> <td>1</td> <td>For spare</td> </tr> <tr> <td>4</td> <td>Thermal constringent tube</td> <td>3</td> <td>Including one spare</td> </tr> <tr> <td>5</td> <td>Color tape</td> <td>1</td> <td>9 colors</td> </tr> <tr> <td>6</td> <td>Terminal</td> <td>3</td> <td></td> </tr> </tbody> </table>		Part name	Q'ty	Remarks	1	Sensor	1	Length: 3 m	2	Sensor Spring (A)	1	For spare	3	Sensor Spring (B)	1	For spare	4	Thermal constringent tube	3	Including one spare	5	Color tape	1	9 colors	6	Terminal	3		
	Part name	Q'ty	Remarks																												
1	Sensor	1	Length: 3 m																												
2	Sensor Spring (A)	1	For spare																												
3	Sensor Spring (B)	1	For spare																												
4	Thermal constringent tube	3	Including one spare																												
5	Color tape	1	9 colors																												
6	Terminal	3																													

13. EXPLODED VIEWS AND PARTS LIST

13-1. Indoor Unit (E-Parts Assy)

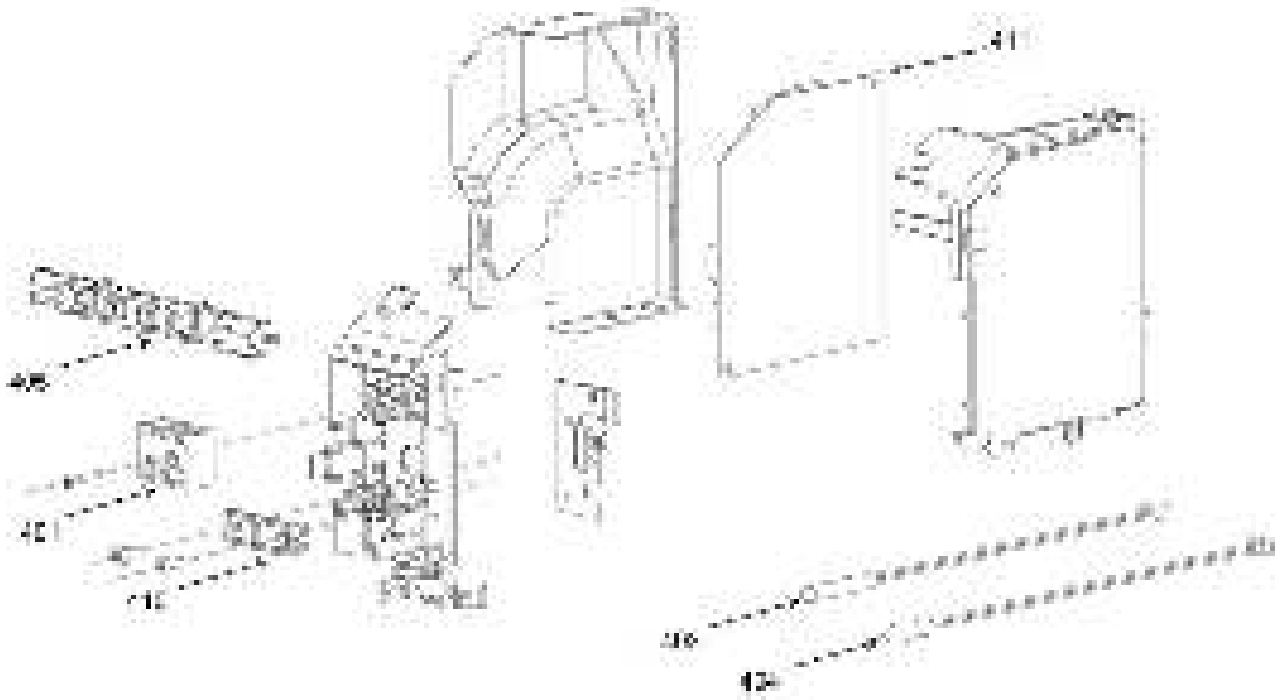

Location No.	Part No.	Description	Location No.	Part No.	Description
401	43T60365	TERMINAL BLOCK; 3P	405	43T69612	DISPLAY UNIT
403	43T69319	TEMPERATURE SENSOR	410	43T62003	CORD CLAMP
404	43T69320	TEMPERATURE SENSOR	411	43T69824	PC BOARD

13-2. Indoor Unit

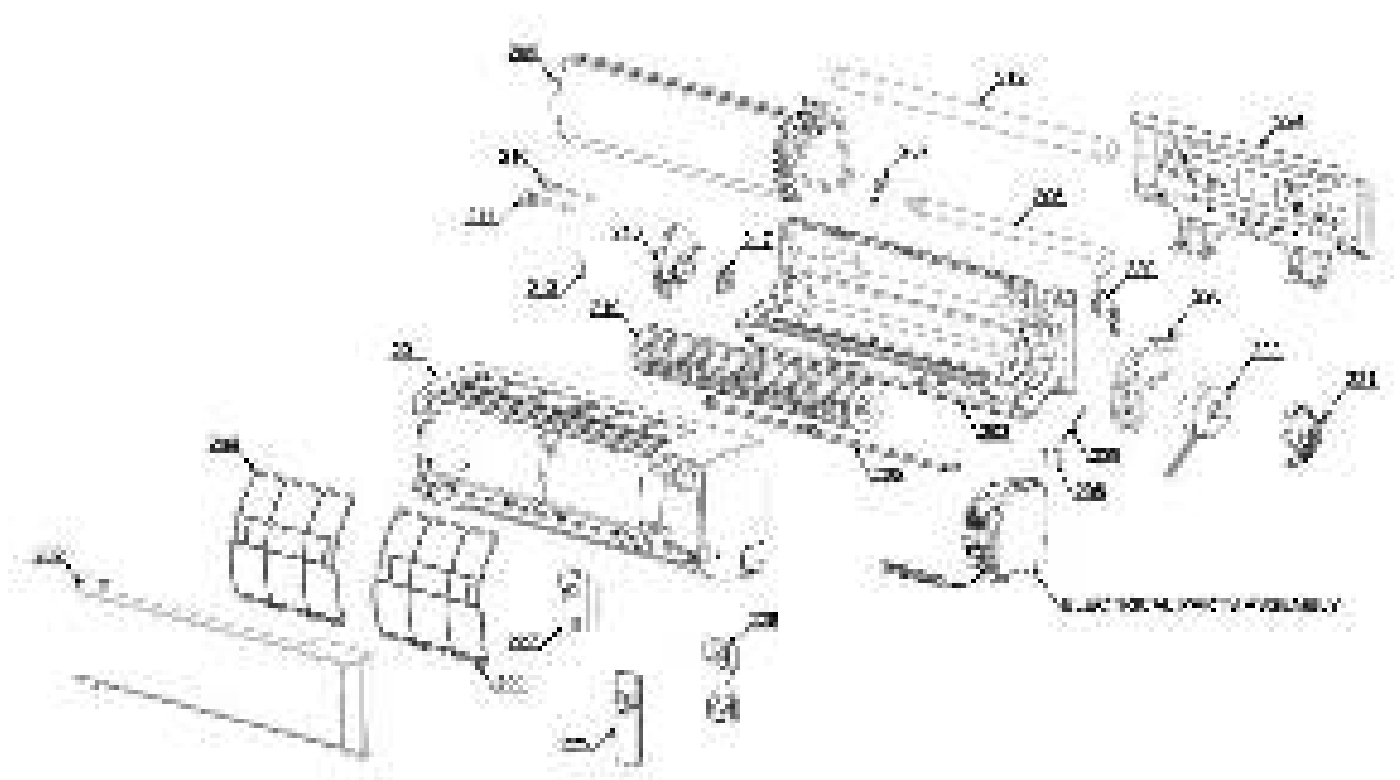

Location No.	Part No.	Description	Location No.	Part No.	Description
201	43T00581	FRONT PANEL ASSY	217	43T22312	BEARING ASSY, MOLD
202	43T09476	GRILLE OF AIR INLET	218	43T39323	BEARING BASE
203	43T03357	BACK BODY ASSY	219	43T20323	ASSY CROSS FLOW FAN
204	43T80326	AIR-FILTER	220	43T39324	MOTOR BAND (LEFT)
205	43T09392	HORIZONTAL LOUVER	221	43T39321	MOTOR BAND(RIGHT)
206	43T70313	HOSE, DRAIN	222	43T21409	FAN MOTOR
207	43T79301	CAP-DRAIN	224	43T82309	INSTALLATION PLATE
208	43T21402	MOTOR; STEPPING	225	43T66315	WIRELESS REMOTE CONTROLLER
209	43T44387	REFRIGERATION CYCLE ASSY	226	43T83305	HOLDER, REMOTE CONTROL
210	43T47353	PIPE; SUCTION	227	43T62326	TERMINAL COVER
211	43T47355	PIPE; SUCTION	228	43T60317	CORD MOTOR LOUVER
212	43T11319	PIPE SHIELD	229	43T07311	PIPE HOLDER
213	43T19333	HOLDER, SENSOR			

13-3. Outdoor Unit

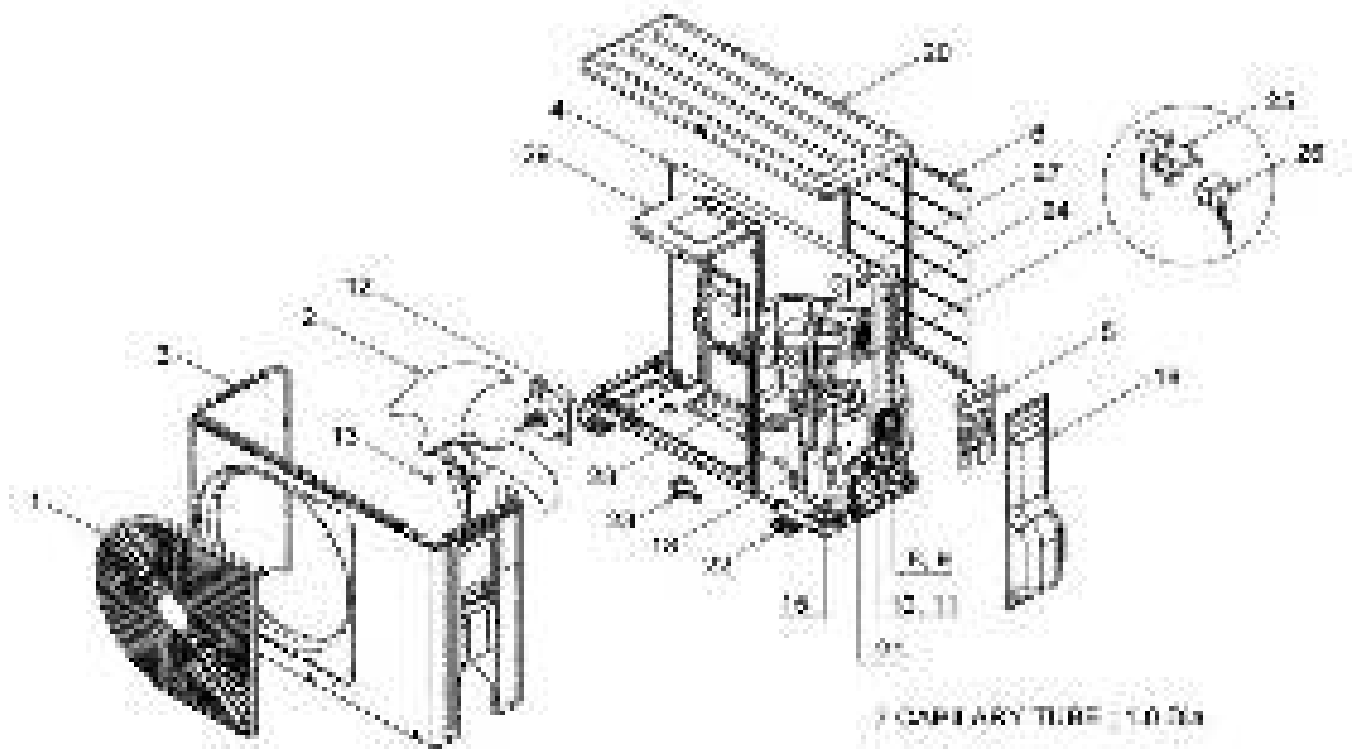

Location No.	Part No.	Description	Location No.	Part No.	Description
1	43T19335	FAN GUARD	15	43T49327	CUSHION,RUBBER
2	43T20327	PROPELLER FAN	18	43T41423	COMPRESSOR
3	43T00482	FRONT CABINET	19	43T19337	PACKED VALVE COVER
4	43T43403	CONDENSOR ASSEMBLY	20	43T00481	UPPER CABINET
5	43T62323	TERMINAL COVER	21	43T00448	FIXING PLATE VALVE
6	43T19341	FIN GUARD	22	43T42331	BASE PLATE ASSEMBLY
7	43T47308	CAPILLARY TUBE; 1.0 DIA	23	43T79305	DRAIN NIPPLE
8	43T46366	VALVE;PACKED 9.52 DIA	24	43T46351	REACTOR
9	43T47332	BONNET, 9.52 DIA	25	43T46343	4 WAY VALVE
10	43T46332	VALVE;PACKED 6.35 DIA	26	43T63320	4 WAY VALVE COIL ASSEMBLY
11	43T47331	BONNET, 6.35 DIA	27	43T04305	PARTITION
12	43T21400	FAN-MOTOR	28	43T39325	MOTOR BASE
13	43T47001	NUT FLANGE	29	43T39334	MOTOR BASE CONNECTION PLATE

13-4. Outdoor Unit (E-Parts Assy)

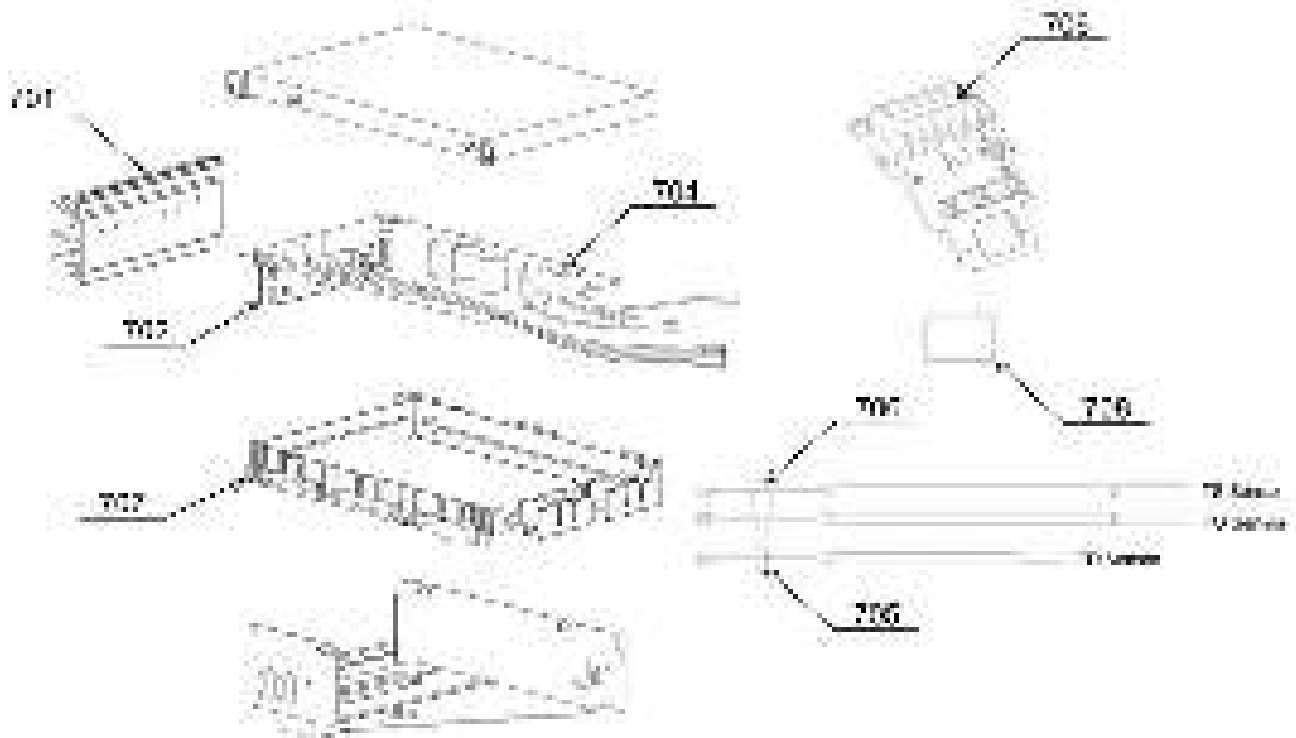

Location No.	Part No.	Description
701	43T62320	HEATSINK
702	43T69819	PC BOARD
703	43T60392	TERMINAL-5P
704	43T60326	FUSE

Location No.	Part No.	Description
705	43T60377	TEMPERATURE SENSOR
706	43T50304	SENSOR;HEAT EXCHANGER
707	43T62313	BASE-PLATE-PC
708	43T55325	CAPACITOR; PLASTIC-FILM



T O S H I B A C A R R I E R C O R P O R A T I O N

