

Operating Instructions Air Conditioner



Model No.

Indoor Unit

**CS-E9NKUAW
CS-E12NKUAW**

Single Split

**Outdoor Unit
CU-E9NKUA
CU-E12NKUA**

Multi Split

**Outdoor Unit
CU-2E18NBU
CU-5E36QBU**



ENGLISH

2-10

Operating Instructions Air Conditioner

Thank you for purchasing Panasonic Air Conditioner.
Installation instructions attached.
Before operating the unit, read these operating instructions thoroughly and keep them for future reference.

FRANÇAIS

11-20

Instructions d'utilisation Climatiseur

Merci d'avoir acheté un climatiseur Panasonic.
Instructions d'installation en annexe.
Avant d'utiliser le climatiseur, lire ces instructions d'utilisation et les conserver pour s'y référer dans le futur.



**QUICK GUIDE
GUIDE SOMMAIRE**

TABLE OF CONTENTS

SAFETY PRECAUTIONS

2~3

MULTI AIR CONDITIONER SYSTEM

4

INDOOR UNIT

5

REMOTE CONTROL

6~7

TROUBLESHOOTING

8~9

INFORMATION

10

QUICK GUIDE

BACK COVER

NOTE

The illustrations in this manual are for explanation purposes only and may differ from the actual unit. They are subjected to change without notice for future improvement.

OPERATION CONDITION

Use this air conditioner under the following temperature range

Temperature (°F/°C)	Indoor		
	*DBT	*WBT	
COOLING	Max.	89.6/32	73.4/23
	Min.	60.8/16	51.8/11
HEATING	Max.	86.0/30	-/-
	Min.	60.8/16	-/-

Temperature (°F/°C)	Outdoor		
	CU-E9NKUA, CU-E12NKUA	*DBT	*WBT
COOLING	Max.	114.8/46	78.8/26
	Min.	5.0/-15	-/-
HEATING	Max.	75.2/24	64.4/18
	Min.	5.0/-15	3.2/-16

Temperature (°F/°C)	Outdoor		
	CU-2E18NBU, CU-5E36QBU	*DBT	*WBT
COOLING	Max.	114.8/46	78.8/26
	Min.	14.0/-10	-/-
HEATING	Max.	75.2/24	64.4/18
	Min.	5.0/-15	3.2/-16

*DBT: Dry bulb temperature

*WBT: Wet bulb temperature

SAFETY PRECAUTIONS

To prevent personal injury, injury to others, or property damage, please comply with the following.

Incorrect operation due to failure to follow instructions below may cause harm or damage, the seriousness of which is classified as below:



WARNING

This sign warns of death or serious injury.



CAUTION

This sign warns of injury or damage to property.

The instructions to be followed are classified by the following symbols:



This symbol denotes an action that is **PROHIBITED**.



These symbols denote an actions that is **COMPULSORY**.



WARNING

INDOOR UNIT AND OUTDOOR UNIT



This appliance is not intended for use by persons (including children) with reduced physical, sensory or mental capabilities, or lack of experience and knowledge, unless they have been given supervision or instruction concerning use of the appliance by a person responsible for their safety. Children should be supervised to ensure that they do not play with the appliance.

Please consult authorized dealer or specialist to clean the internal parts, repair, install, remove and reinstall the unit. Improper installation and handling will cause leakage, electric shock or fire.

Confirm to authorized dealer or specialist on usage of specified refrigerant type. Using of refrigerant other than the specified type may cause product damage, burst and injury etc.



Do not install the unit in a potentially explosive or flammable atmosphere. Failure to do so could result in fire.

Do not insert your fingers or other objects into the air conditioner indoor or outdoor unit, rotating parts may cause injury.









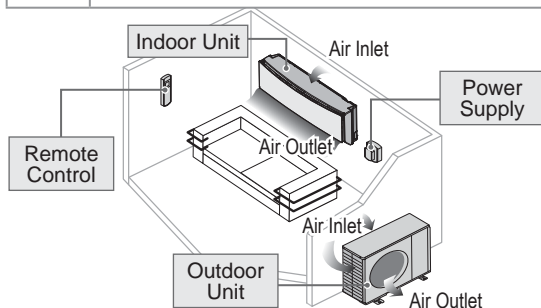







Do not touch the outdoor unit during lightning, it may cause electric shock.

Do not expose yourself directly to cold air for a long period to avoid excess cooling.

Do not sit or step on the unit, you may fall down accidentally.



 WARNING	
REMOTE CONTROL	
	Do not allow infants and small children to play with the remote control to prevent them from accidentally swallowing the batteries.
POWER SUPPLY	
	Do not use a modified cord, joint cord, extension cord or unspecified cord to prevent overheating and fire.  
	To prevent overheating, fire or electric shock: <ul style="list-style-type: none"> • Do not share the same power outlet with other equipment. • Do not operate with wet hands. • Do not over bend the power supply cord.
	If the supply cord is damaged, it must be replaced by the manufacturer, its service agent or similarly qualified persons in order to avoid a hazard. <p>It is strongly recommended to install this unit using an Earth Leakage Circuit Breaker (ELCB) or Ground Fault Interrupt (GFCI) or Appliance Leakage Current Interrupt (ALCI) to prevent electric shock or fire.</p> <p>Stop using the product if any abnormality/failure occurs or turn off the power switch and breaker. (Risk of smoke/fire/electric shock)</p> <p>Examples of abnormality/failure</p> <ul style="list-style-type: none"> • The ELCB or GFCI or ALCI trip frequently. • Burning smell is observed. • Abnormal noise or vibration of the unit is observed. • Water leaks from the indoor unit. • Power cord becomes abnormally hot. • Fan speed cannot be controlled. • The unit stops running immediately even if it is switched on for operation. • The fan does not stop even if the operation is stopped. <p>Contact your local dealer immediately for maintenance or repair assistance.</p>
	This equipment must be earthed to prevent electrical shock or fire.
	Prevent electric shock by switching off the power: <ul style="list-style-type: none"> - Before cleaning or servicing. - Extended non-use. - Abnormally strong lightning activity.

 CAUTION	
INDOOR UNIT AND OUTDOOR UNIT	
	Do not wash the indoor unit with water, benzene, thinner or scouring powder to avoid damage or corrosion at the unit.
	Do not use for preservation of precise equipment, food, animals, plants, artwork or other objects. This may cause quality deterioration, etc.
	Do not use any combustible equipment in front of the airflow outlet to avoid fire propagation.
	Do not expose plants or pet directly to airflow to avoid injury, etc.
	Do not touch the sharp aluminium fin, sharp parts may cause injury. 
	Do not switch ON the indoor unit when waxing the floor. After waxing, aerate the room properly before operating the unit.
	Do not install the unit in oily and smoky areas to prevent damage to the unit.
	Do not dismantle the unit for cleaning purpose to avoid injury.
	Do not step onto an unstable bench when cleaning the unit to avoid injury.
	Do not place a vase or water container on the unit. Water may enter the unit and degrade the insulation. This may cause an electric shock.
	Do not open window or door for long time during COOL/DRY mode operation.
	Ensure drainage pipe is connected properly and keep drainage outlet clear of gutters, containers or does not immersed in water to prevent water leakage. <p>After a long period of use or use with any combustible equipment, aerate the room regularly.</p> <p>After a long period of use, make sure the installation rack does not deteriorate to prevent the unit from falling down.</p>
REMOTE CONTROL	
	Do not use rechargeable (Ni-Cd) batteries. It may damage the remote control.
	To prevent malfunction or damage of the remote control: <ul style="list-style-type: none"> • Remove the batteries if the unit is not going to be used for a long period of time. • New batteries of the same type must be inserted following the polarity stated.

MULTI AIR CONDITIONER SYSTEM

Multi Split Outdoor Unit
(CU-2E18NBU, CU-5E36QBU)

DEFINITION

Multi air conditioner systems save space by letting you connect multiple indoor units to a single outdoor unit.

INDOOR UNIT

- It is possible to operate the indoor units individually or simultaneously. The operation mode priority is given to the first unit that turned on.
- During operation, heating and cooling mode can not be activated at the same time for different indoor unit. The power indicator blinks to indicate the indoor unit is standing by for different operation mode.

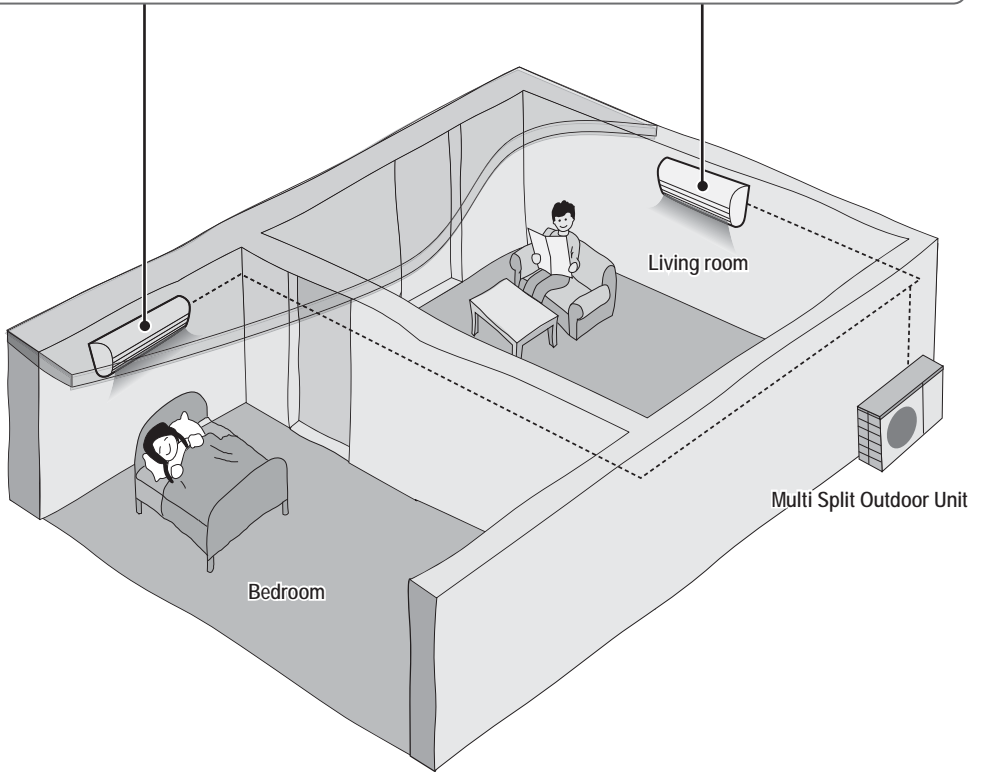

POWER SUPPLY

	Models Number	Time Delay Circuit Breaker	Rated Volts
Single Split System	CS-E9NKUAW / CU-E9NKUA	15 Amps	208/230V
	CS-E12NKUAW / CU-E12NKUA	15 Amps	
Multi Split System	CS-E9NKUAW / CS-E12NKUAW / CU-2E18NBU	25 Amps	208/230V
	CS-E9NKUAW / CS-E12NKUAW / CU-5E36QBU	45 Amps	

INDOOR UNIT

- Switch off the power at the circuit breaker before cleaning.
- Do not touch the aluminium fin, sharp parts may cause injury.

CLEANING INSTRUCTIONS

- Do not use benzene, thinner or scouring powder.
- Use only soap (≈ pH7) or neutral household detergent.
- Do not use water hotter than 104°F/40°C.

HINT

- To ensure optimal performance of the unit, cleaning maintenance has to be carried out at regular intervals. A dirty unit may cause malfunction and you may see error code "H99". Please consult authorized dealer.

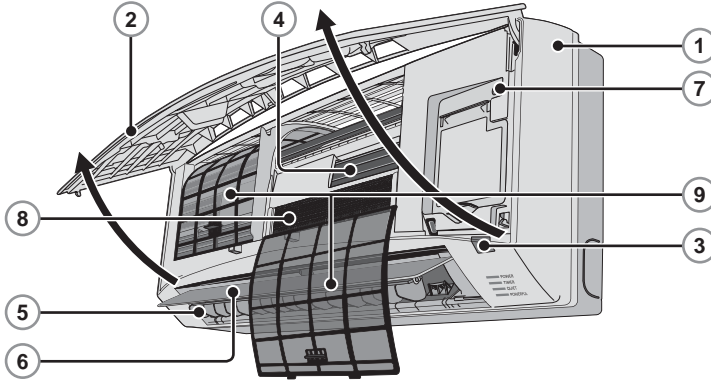

1 INDOOR UNIT

- Wipe the unit gently with a soft, dry cloth.

2 FRONT PANEL

Remove Front Panel

- Raise and pull to remove the front panel.
- Wash gently and dry.

Close Front Panel



- Press down both ends of the front panel to close it securely.

3 REMOTE CONTROL RECEIVER

4 ALUMINIUM FIN

5 HORIZONTAL AIRFLOW DIRECTION LOUVER

- Manually adjustable.



6 VERTICAL AIRFLOW DIRECTION LOUVER

- Do not adjust by hand.

7 AUTO OFF/ON BUTTON

- Use when remote control is misplaced or a malfunction occurs.

Step	Action	Mode
1	Press once.	Automatic
2	Press and hold until you hear one beep, then release.	Force cooling
3	Repeat step 2. Press and hold until you hear two beeps, then release.	Normal cooling
4	Repeat step 3. Press and hold until you hear three beeps, then release.	Force heating

Press the button to turn off.

8 AIR PURIFYING FILTER



Vacuum the air purifying filter.

- It is recommended to clean the filter every 6 months.
- Replace the filter every 3 years or replace any damaged filter. Part no.: CZ-SA20P

9 AIR FILTERS

- Air filter cleaning is required every two weeks.
- Wash/rinse the filters gently with water to avoid damage to the filter surface.
- Dry the filters thoroughly under shade, away from fire or direct sunlight.
- Replace any damaged filters.

REMOTE CONTROL

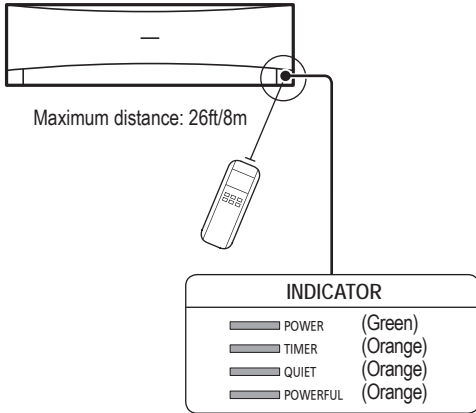

Remote Control display

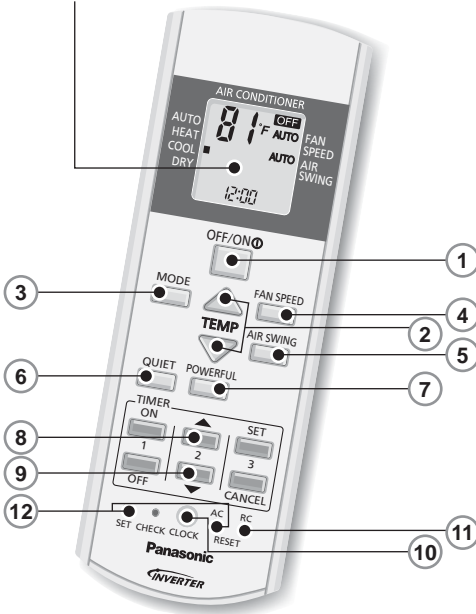

Press the remote control's button

1 TO TURN ON OR OFF THE UNIT



- Please be aware of the OFF indication on the remote control display to prevent the unit from starting/stopping improperly.

2 TO SET TEMPERATURE

- Selection range : 60°F ~ 86°F / 16°C ~ 30°C.
- Operating the unit within the recommended temperature could induce energy saving.
 HEAT mode : 68°F ~ 75°F / 20°C ~ 24°C.
 COOL mode : 78°F ~ 82°F / 26°C ~ 28°C.
 DRY mode : 2°F ~ 4°F / 1°C ~ 2°C lower than room temperature.

3 TO SELECT OPERATION MODE

AUTO mode - For your convenience

- During operation mode selection the power indicator blinks.
- Unit selects operation mode every 10 minutes according to temperature setting and room temperature (For Single Split System).
- Unit selects operation mode every 3 hours according to temperature setting, outdoor and room temperature (For Multi Split System).

HEAT mode - To enjoy warm air

- Unit takes a while to warm up. The power indicator blinks during this operation.

COOL mode - To enjoy cool air

- Use curtains to screen off sunlight and outdoor heat to reduce power consumption during cool mode.

DRY mode - To dehumidify the environment

- Unit operates at low fan speed to give a gentle cooling operation.

4 TO SELECT FAN SPEED



- For AUTO, the indoor fan speed is automatically adjusted according to the operation mode.

5 TO ADJUST VERTICAL AIRFLOW DIRECTION



- Keeps the room ventilated.
- In COOL/DRY mode, if AUTO is set, the louver swing up/down automatically.
- In HEAT mode, if AUTO is set, the louver fix at predetermined position.

6 TO ENJOY QUIET OPERATION



- This operation reduces airflow noise.

7 TO REACH TEMPERATURE QUICKLY



- Single Split System: This operation stops automatically after 20 minutes.
- Multi Split System: Press the button again or turn OFF the unit to stop this operation.

8 Press and hold for 5 seconds to dim or restore the unit's indicator brightness.

9 Press and hold for approximately 10 seconds to show temperature setting in °F or °C.

10 Press and hold for approximately 5 seconds to show 12-hour (am/pm) or 24-hour time indication.

11 Press to restore the remote control's default setting.

12 Not used in normal operations.

NOTES



- Can be activated in all modes and can be cancelled by pressing the respective button again.
- Cannot be selected at the same time.

TO SET THE TIMER

- To turn ON or OFF the unit at a preset time.

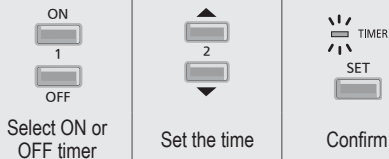

- To cancel ON or OFF timer, press or then press .
- When ON Timer is set, the unit may start earlier (up to 35 minutes) before the actual set time in order to achieve the desired temperature on time.
- Timer operation is based on the clock set in the remote control and repeats daily once set. For clock setting, please refer to Remote Control Preparation on the back cover.
- If timer is cancelled manually or due to power failure, you can restore the previous setting (once power is resumed) by pressing .

TROUBLESHOOTING

The following symptoms do not indicate malfunction.

SYMPTOM	CAUSE
Mist emerges from indoor unit.	▶ • Condensation effect due to cooling process.
Water flowing sound during operation.	▶ • Refrigerant flow inside the unit.
The room has a peculiar odor.	▶ • This may be due to damp smell emitted by the wall, carpet, furniture or clothing.
Indoor fan stops occasionally during automatic fan speed setting.	▶ • This helps to remove the surrounding odours.
Airflow continues even after operation has stopped.	▶ • Extraction of remaining heat from the indoor unit (maximum 30 seconds).
Operation is delayed a few minutes after restarting.	▶ • The delay is a protection to the unit's compressor.
Outdoor unit emits water/steam.	▶ • Condensation or evaporation occurs on pipes.
TIMER indicator is always on.	▶ • The timer setting repeats daily once set.
POWER indicator blinks during HEAT mode with no warm air supply (and louver is closed).	▶ • The unit is in defrost mode (and AIR SWING is set to AUTO).
Indoor fan stops occasionally during heating operation.	▶ • To avoid unintended cooling effect.
Power indicator blinks before the unit is switched on.	▶ • This is a preliminary step in preparation for the operation when the ON timer has been set.
Cracking sound during operation.	▶ • Changes of temperature caused the expansion/contraction of the unit.

Check the following before calling for servicing.

SYMPTOM	CHECK
Heating/Cooling operation is not working efficiently.	▶ • Set the temperature correctly. • Close all doors and windows. • Clean or replace the filters. • Clear any obstruction at the air inlet and air outlet vents.
Noisy during operation.	▶ • Check if the unit has been installed at an incline. • Close the front panel properly.
Remote control does not work. (Display is dim or transmission signal is weak.)	▶ • Insert the batteries correctly. • Replace weak batteries.
The unit does not work.	▶ • Check if the circuit breaker is tripped. • Check if timers have been set.
The unit does not receive the signal from the remote control.	▶ • Make sure the receiver is not obstructed. • Certain fluorescent lights may interfere with signal transmitter. Please consult authorized dealer.

TROUBLESHOOTING

The unit stops and the TIMER indicator blinks.
Use remote control to retrieve error code.

1 Press for 5 seconds.

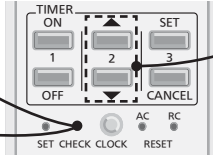

2 Press until you hear beep sound, then write down the error code.

3 Press for 5 seconds to quit checking.

4 Turn the unit off and reveal the error code to authorised dealer

• For certain errors, you may restart the unit for limited operation with 4 beeps when operation starts.

Diagnostic display	Abnormality/Protection control
H 00	No memory of failure
H 11	Indoor/outdoor abnormal communication
H 12	Indoor unit capacity unmatched
H 14	Indoor intake air temperature sensor abnormality
H 15	Compressor temperature sensor abnormality
H 16	Outdoor current transformer (CT) abnormality
H 19	Indoor fan motor mechanism lock
H 23	Indoor heat exchanger temperature sensor abnormality
H 24	Indoor heat exchanger temperature sensor 2 abnormality
H 27	Outdoor air temperature sensor abnormality
H 28	Outdoor heat exchanger temperature sensor 1 abnormality
H 30	Outdoor discharge pipe temperature sensor abnormality
H 32	Outdoor heat exchanger temperature sensor 2 abnormality
H 33	Indoor/outdoor misconnection abnormality
H 36	Outdoor gas pipe temperature sensor abnormality

Diagnostic display	Abnormality/Protection control
H 37	Outdoor liquid pipe temperature sensor abnormality
H 38	Indoor/outdoor mismatch (brand code)
H 39	Abnormal indoor operating unit or standby units
H 64	Outdoor high pressure sensor abnormality
H 97	Outdoor fan motor mechanism lock
H 98	Indoor high pressure protection
H 99	Indoor operating unit freeze protection
F 11	4-way valve switching abnormality *1
F 17	Indoor standby units freezing abnormality
F 90	Power factor correction (PFC) circuit protection
F 91	Refrigeration cycle abnormality
F 93	Compressor abnormal revolution
F 94	Compressor discharge pressure overshoot protection
F 95	Outdoor cooling high pressure protection
F 96	Power transistor module overheating protection
F 97	Compressor overheating protection
F 98	Total running current protection
F 99	Outdoor direct current (DC) peak detection

*1 For cooling only model, it is the indication when indoor heat exchanger sensor or indoor air intake sensor has abnormality.

INFORMATION

FOR SEASONAL INSPECTION AFTER EXTENDED NON-USE

- Check remote control batteries.
- No obstruction at air inlet and air outlet vents.
- Use Auto OFF/ON button to select Cooling/Heating operation.
- After 15 minutes of operation, it is normal to have the following temperature difference between air inlet and air outlet vents:
Cooling: $\geq 14.4^{\circ}\text{F}/8^{\circ}\text{C}$ Heating: $\geq 25.2^{\circ}\text{F}/14^{\circ}\text{C}$

FOR EXTENDED NON-USE

- Activate Heat mode for 2~3 hours to remove moisture left in the internal parts thoroughly to prevent mold growth.
- Switch off power at the circuit breaker.
- Remove the remote control batteries.

NON SERVICEABLE CRITERIAS

SWITCH OFF POWER AT THE CIRCUIT BREAKER then please consult an authorized dealer under the following conditions:

- Abnormal noise during operation.
- Water/foreign particles have entered the remote control.
- Water leaks from Indoor unit.
- Circuit breaker switches off frequently.
- Switches or buttons are not functioning properly.

Information for Users on Collection and Disposal of Old Equipment and used Batteries



[Information on Disposal in other Countries outside the European Union]

These symbols are only valid in the European Union. If you wish to discard these items, please contact your local authorities or dealer and ask for the correct method of disposal.



Note for the battery symbol (bottom two symbol examples):

This symbol might be used in combination with a chemical symbol. In this case it complies with the requirement set by the Directive for the chemical involved.

Pb

Contact your local hazardous waste disposal hotline.

Models Number

CS-E9NKUAW / CU-E9NKUA
CS-E12NKUAW / CU-E12NKUA



The above listed models have been designed and manufactured to meet ENERGY STAR® criteria for energy efficiency when matched with appropriate coil components. However, proper refrigerant charge and proper air flow are critical to achieve rated capacity and efficiency. Installation of this product should follow the manufacturer's refrigerant charging and airflow instructions. Failure to confirm proper charge and airflow may reduce energy efficiency and shorten equipment life.

Federal Communications Commission Interference Statement

This device complies with part 15 of the FCC Rules. Operation is subject to the following two conditions: (1) This device may not cause harmful interference, and (2) this device must accept any interference received, including interference that may cause undesired operation.

This equipment has been tested and found to comply with the limits for a Class B digital device, pursuant to part 15 of the FCC Rules. These limits are designed to provide reasonable protection against harmful interference in a residential installation. This equipment generates, uses and can radiate radio frequency energy and, if not installed and used in accordance with the instructions, may cause harmful interference to radio communications. However, there is no guarantee that interference will not occur in a particular installation. If this equipment does cause harmful interference to radio or television reception, which can be determined by turning the equipment off and on, the user is encouraged to try to correct the interference by one or more of the following measures:

- Reorient or relocate the receiving antenna.
- Increase the separation between the equipment and the receiver.
- Connect the equipment to an outlet on a circuit different from that to which the receiver is connected.
- Consult the dealer or an experienced radio/TV technician for help.

FCC Caution: To assure continued compliance, follow the attached installation instructions. Any changes or modifications not expressly approved by the party responsible for compliance could void the user's authority to operate this equipment.

Industry Canada Notice

This Class B digital apparatus complies with Canadian ICES-003.

QUICK GUIDE/GUIDE SOMMAIRE

Remote Control Preparation • Préparation de la télécommande

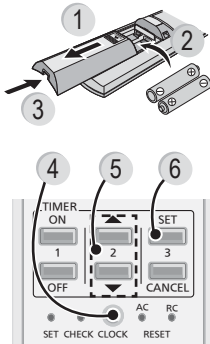

- 1 Pull out • Dégager le couvercle
- 2 Insert AAA or R03 batteries (can be used ~ 1 year) • Mettre en place des piles AAA ou R03 (durée de vie d'environ 1 an)
- 3 Close the cover • Remettre le couvercle en place
- 4 Press CLOCK • Appuyer sur CLOCK
- 5 Set time • Régler l'heure
- 6 Confirm • Confirmer

1 MODE

↻ AUTO → HEAT
 DRY ← COOL ↻

Select the desired mode.
Sélectionner le mode voulu.

2 OFF/ON

Start/stop the operation.
Mettre l'appareil en/hors marche.

3 TEMP

Select the desired temperature.
Régler la température souhaitée.

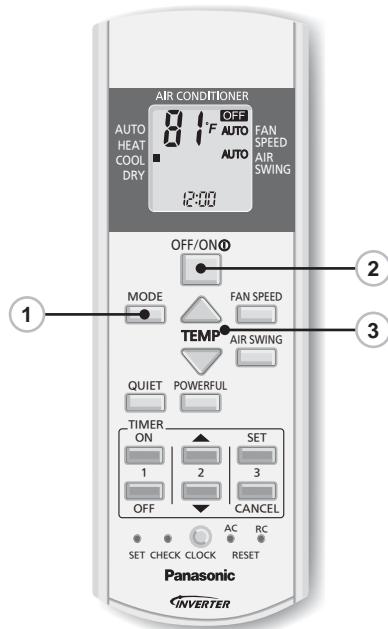

Panasonic Corporation

Website: <http://panasonic.net/>

Panasonic Canada Inc.

Website: <http://www.panasonic.com>