

HITACHI

PM

NO. 0271E

**RAI-25NH5
RAI-35NH5**

SERVICE MANUAL TECHNICAL INFORMATION

REFER TO THE FOUNDATION MANUAL

FOR SERVICE PERSONNEL ONLY

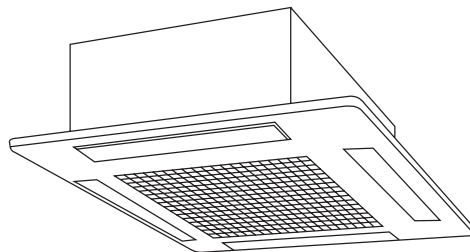

RAI-ECPM
RAI-25NH5
RAI-35NH5



CONTENTS

SPECIFICATIONS	4
HOW TO USE	6
CONSTRUCTION AND DIMENSIONAL DIAGRAM	27
MAIN PARTS COMPONENT	28
WIRING DIAGRAM	29
CIRCUIT DIAGRAM	31
PRINTED WIRING BOARD LOCATION DIAGRAM	35
BLOCK DIAGRAM	37
BASIC MODE	39
REFRIGERATING CYCLE DIAGRAM	53
AUTO SWING FUNCTION	55
DESCRIPTION OF MAIN CIRCUIT OPERATION	56
SERVICE CALL Q & A	61
TROUBLE SHOOTING	64
PARTS LIST AND DIAGRAM	69

NOTE:

This manual describes only points that differ from RAK-18NH5, 25NH5, 35NH5 (PM NO. 0269E) and RAM-40QH5 (PM NO. 0270E) for items not described in this manual.

SPECIFICATIONS

TYPE		DC INVERTER (CEILING CASSETTE TYPE)	
		INDOOR UNIT	
MODEL		RAI-25NH5	RAI-35NH5
POWER SOURCE		1 PHASE, 50 Hz, 220-240V	1 PHASE, 50 Hz, 220-240V
COOLING	TOTAL INPUT (W)	REFER TO THE SPECIFICATIONS PAGE (5)	
	TOTAL AMPERES (A)		
	CAPACITY		
(B.T.U./h)			
HEATING	TOTAL INPUT (W)		
	TOTAL AMPERES (A)		
	CAPACITY	(kW)	
(B.T.U./h)			
DIMENSIONS (mm)	W	580	580
	H	285	285
	D	580	580
NET WEIGHT (kg)		20	20

SPECIFICATIONS AND PARTS ARE SUBJECT TO CHANGE FOR IMPROVEMENT

ROOM AIR CONDITIONER

INDOOR UNIT

SEPTEMBER 2005 Refrigeration & Air-Conditioning Division

SAFETY DURING REPAIR WORK

1. In order to disassemble and repair the unit in question, be sure to disconnect the power cord plug from the power outlet before starting the work.

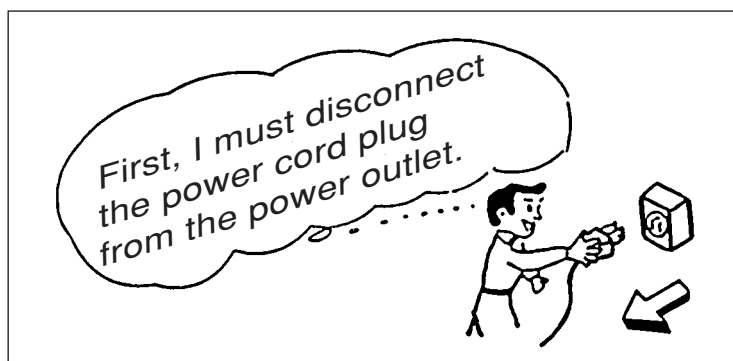

2. If it is necessary to replace any parts, they should be replaced with respective genuine parts for the unit, and the replacement must be effected in correct manner according to the instructions in the Service Manual of the unit.

If the contacts of electrical parts are defective, replace the electrical parts without trying to repair them.

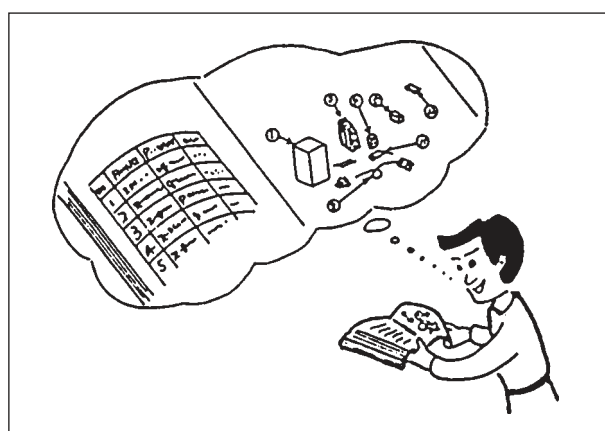

3. After completion of repairs, the initial state should be restored.
4. Lead wires should be connected and laid as in the initial state.
5. Modification of the unit by user himself should absolutely be prohibited.
6. Tools and measuring instruments for use in repairs or inspection should be accurately calibrated in advance.
7. In installing the unit having been repaired, be careful to prevent the occurrence of any accident such as electrical shock, leak of current, or bodily injury due to the drop of any part.
8. To check the insulation of the unit, measure the insulation resistance between the power cord plug and grounding terminal of the unit. The insulation resistance should be $1M\Omega$ or more as measured by a 500V DC megger.
9. The initial location of installation such as window, floor or the other should be checked for being and safe enough to support the repaired unit again. If it is found not so strong and safe, the unit should be installed at the initial location reinforced or at a new location.
10. Any inflammable thing should never be placed about the location of installation.
11. Check the grounding to see whether it is proper or not, and if it is found improper, connect the grounding terminal to the earth.



WORKING STANDARDS FOR PREVENTING BREAKAGE OF SEMICONDUCTORS

1. Scope

The standards provide for items to be generally observed in carrying and handling semiconductors in relative manufacturers during maintenance and handling thereof. (They apply the same to handling of abnormal goods such as rejected goods being returned).

2. Object parts

- (1) Micro computer
- (2) Integrated circuits (IC)
- (3) Field-effect transistors (FET)
- (4) P.C. boards or the like on which the parts mentioned in (1) and (2) of this paragraph are equipped.

3. Items to be observed in handling

- (1) Use a conductive container for carrying and storing of parts. (Even rejected goods should be handled in the same way).

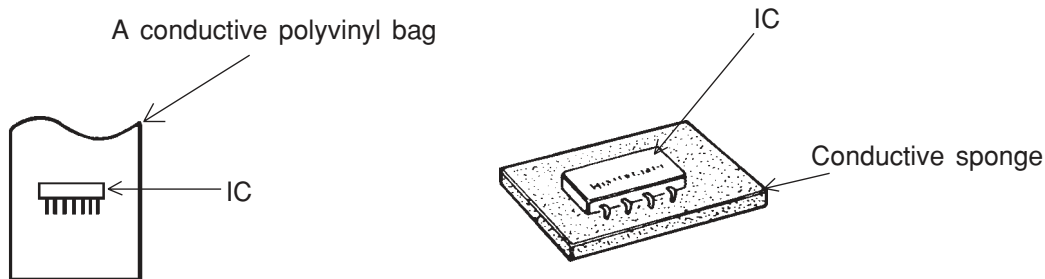

Fig. 1. Conductive Container

- (2) When any part is handled uncovered (in counting, packing and the like), the handling person must always use himself as a body earth. (Make yourself a body earth by passing one M ohm earth resistance through a ring or bracelet).
- (3) Be careful not to touch the parts with your clothing when you hold a part even if a body earth is being taken.
- (4) Be sure to place a part on a metal plate with grounding.
- (5) Be careful not to fail to turn off power when you repair the printed circuit board. At the same time, try to repair the printed circuit board on a grounded metal plate.

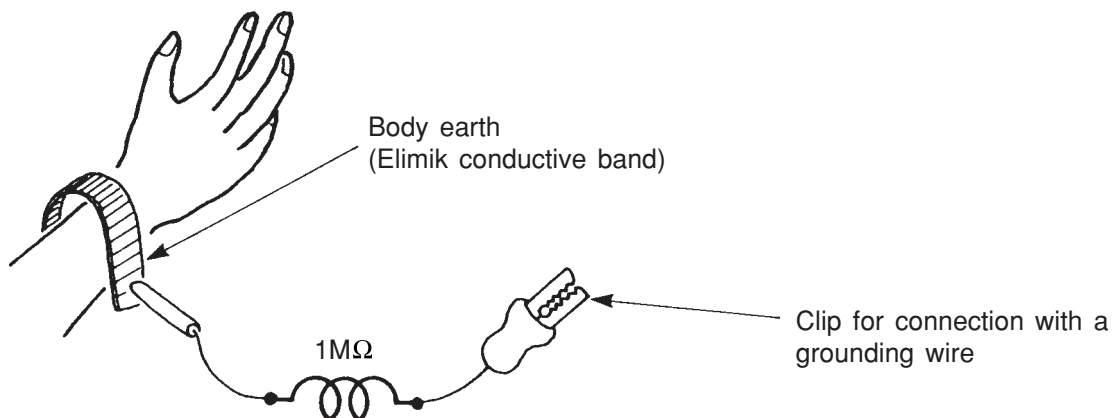

Fig. 2. Body Earth

(6) Use a three wire type soldering iron including a grounding wire.

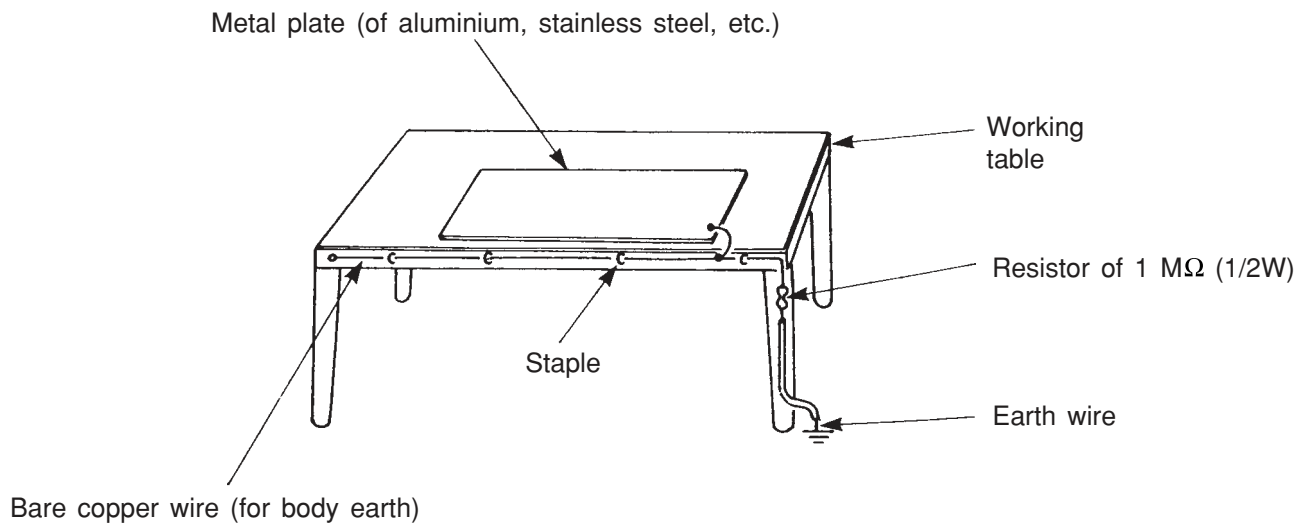

Fig. 3. Grounding of the working table

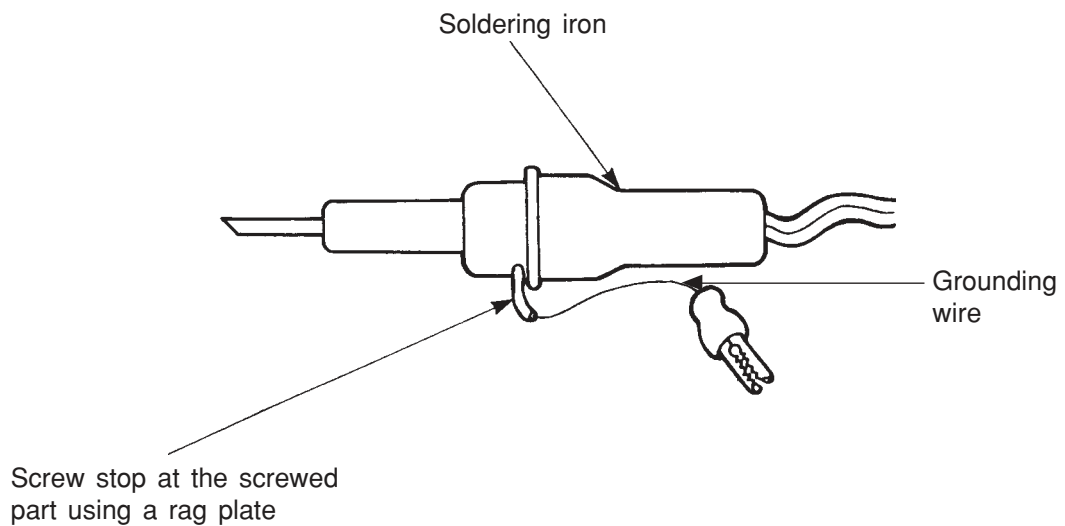

Fig. 4. Grounding a soldering iron

Use a high insulation mode (100V, 10MΩ or higher) when ordinary iron is to be used.

(7) In checking circuits for maintenance, inspection or some others, be careful not to have the test probes of the measuring instrument shortcircuit a load circuit or the like.

 **CAUTION**

1. In quiet operation or stopping the running, slight flowing noise of refrigerant in the refrigerating cycle is heard occasionally, but this noise is not abnormal for the operation.
2. When it thunders near by, it is recommend to stop the operation and to disconnect the power cord plug from the power outlet for safety.
3. The room air conditioner does not start automatically after recovery of the electric power failure for preventing fuse blowing. Re-press START/STOP button after 3 minutes from when unit stopped.
4. If the room air conditioner is stopped by adjusting thermostat, or missoperation, and re-start in a moment, there is occasion that the cooling and heating operation does not start for 3 minutes, it is not abnormal and this is the result of the operation of IC delay circuit. This IC delay circuit ensures that there is no danger of blowing fuse or damaging parts even if operation is restarted accidentally.
5. This room air conditioner should not be used at the cooling operation when the outside temperature is below 10°C (50°F).
6. This room air conditioner (the reverse cycle) should not be used when the outside temperature is below -15°C (5°F).
If the reverse cycle is used under this condition, the outside heat exchanger is frosted and efficiency falls.
7. When the outside heat exchanger is frosted, the frost is melted by operating the hot gas system, it is not trouble that at this time fan stops and the vapour may rise from the outside heat exchanger.

SPECIFICATIONS

MODEL		RAI-25NH5 RAI-35NH5
FAN MOTOR		25W
FAN MOTOR CAPACITOR		NO
FAN MOTOR PROTECTOR		NO
COMPRESSOR		-
COMPRESSOR MOTOR CAPACITOR		NO
OVERLOAD PROTECTOR		NO
OVERHEAT PROTECTOR		NO
FUSE (for MICROPROCESSOR)		NO
POWER RELAY		NO
POWER SWITCH		NO
TEMPORARY SWITCH		YES
SERVICE SWITCH		NO
TRANSFORMER		NO
VARISTOR		NO
NOISE SUPPRESSOR		NO
THERMOSTAT		YES(IC)
REMOTE CONTROL SWITCH (LIQUID CRYSTAL)		YES
REFRIGERANT CHARGING VOLUME (Refrigerant 410A)	UNIT	-----
	PIPES	WITHOUT REFRIGERANT BECAUSE COUPLING IS FLARE TYPE.

SPECIFICATIONS FOR INDOOR UNITS COMBINATIONS



TYPE		CEILING CASSETTE TYPE DC INVERTER QUADRUPLE SYSTEM MULTI COOLING AND HEATING	
MODEL	INDOOR UNIT	RAI-25NH5	RAI-35NH5
	OUTDOOR UNIT	RAM-40QH5	
PHASE/VOLTAGE/FREQUENCY		1ø, 220V-240V, 50Hz	
CIRCUIT AMPERES TO CONNECT (A)		16	
COOLING (ONE UNIT)	CAPACITY (kW) (B.T.U./h)	2.50 (1.00~3.00)	3.50 (1.00~4.00)
		8540 (3412~10236)	11950 (3412~13660)
	TOTAL INPUT (W)	750 (200-880)	1090 (200-1300)
	EER (B.T.U./hW)	11.39	10.96
	TOTAL AMPERES (A)	3.44 ~ 3.16	5.00 ~ 4.59
	POWER FACTOR (%)	99	99
	SOUND LEVEL (INDOOR)	35	39
	AIR FLOW VOLUME (Hi)	8.5m³/min	10.8m³/min
COOLING (TWO UNITS)	CAPACITY (kW) (B.T.U./h)	4.00 (1.50~4.50)	
		13660 (5126~15367)	
	TOTAL INPUT (W)	1245 (200-1800)	
	EER (B.T.U./hW)	10.97	
	TOTAL AMPERES (A)	5.72 ~ 5.24	
	POWER FACTOR (%)	99	
	SOUND LEVEL (OUTDOOR)	49	
HEATING (ONE UNIT)	CAPACITY (kW) (B.T.U./h)	3.40 (1.10~4.40)	4.20 (1.10~5.00)
		11610 (3761~15026)	14340 (3761~17070)
	TOTAL INPUT (W)	870 (200-1120)	1080 (200-1300)
	EER (B.T.U./hW)	13.34	13.28
	TOTAL AMPERES (A)	3.99 ~ 3.66	4.96 ~ 4.55
	POWER FACTOR (%)	99	99
	SOUND LEVEL (INDOOR)	36	40
	AIR FLOW VOLUME (Hi)	8.5m³/min	10.8m³/min
HEATING (TWO UNITS)	CAPACITY (kW) (B.T.U./h)	5.00 (1.50~5.60)	
		17070 (5126~19122)	
	TOTAL INPUT (W)	1350 (200-1780)	
	EER (B.T.U./hW)	12.64	
	TOTAL AMPERES (A)	6.20 ~ 5.68	
	POWER FACTOR (%)	99	
	SOUND LEVEL (OUTDOOR)	51	
AIR DEFLECTORS		YES (AUTO SWING)	YES (AUTO SWING)
FAN SPEED		3	3
LINE CORD		NOT PROVIDED (POWER CORD SHOULD BE PREPARED AND CONNECTED TO OUTDOOR UNIT WHEN INSTALLED)	
REMOTE CONTROL SWITCH		YES (WIRELESS)	YES (WIRELESS)
MAXIMUM LENGTH OF PIPING		MAX. 35m (TWO UNITS TOTAL)	
STANDARD		CE (EMC&LVD)	

MODEL		RAI-25NH5	RAI-35NH5	RAM-40QH5
PACKING (mm)	W	760	760	905
	H	395	395	633
	D	706	706	394
	cu.ft.	7.48	7.48	8.27
GROSSWEIGHT (kg)		25	25	43
FLARENUTSIZE (SMALL/LARGE)		6.35/9.52D	6.35/9.52D	6.35/9.52D, 6.35/9.52D





SAFETY PRECAUTION

- Please read the “Safety Precaution” carefully before operating the unit to ensure correct usage of the unit.
- Pay special attention to signs of “**▲ Warning**” and “**▲ Caution**”. The “Warning” section contains matters which, if not observed strictly, may cause death or serious injury. The “Caution” section contains matters which may result in serious consequences if not observed properly. Please observe all instructions strictly to ensure safety.
- The sign indicate the following meanings.

 Make sure to connect earth line.	 The sign in the figure indicates prohibition.
 Indicates the instructions that must be followed.	





- Please keep this manual after reading.

WARNING	<ul style="list-style-type: none"> ● Do not reconstruct the unit. Water leakage, fault, short circuit or fire may occur if you reconstruct the unit by yourself. 	
	<ul style="list-style-type: none"> ● Please ask your sales agent or qualified technician for the installation of your unit. Water leakage, short circuit or fire may occur if you install the unit by yourself. 	
	<ul style="list-style-type: none"> ● Please use earth line. Do not place the earth line near water or gas pipes, lightning-conductor, or the earth line of telephone. Improper installation of earth line may cause electric shock. 	
CAUTION	<ul style="list-style-type: none"> ● A circuit breaker should be installed depending on the mounting site of the unit. Without a circuit breaker, the danger of electric shock exists. 	
	<ul style="list-style-type: none"> ● Do not install near location where there is flammable gas. The outdoor unit may catch fire if flammable gas leaks around it. 	
	<ul style="list-style-type: none"> ● Please ensure smooth flow of water when installing the drain hose. 	

PRECAUTIONS DURING SHIFTING OR MAINTENANCE

WARNING	<ul style="list-style-type: none"> ● Should abnormal situation arises (like burning smell), please stop operating the unit and turn off the circuit breaker. Contact your agent. Fault, short circuit or fire may occur if you continue to operate the unit under abnormal situation. 	
	<ul style="list-style-type: none"> ● Please contact your agent for maintenance. Improper self maintenance may cause electric shock and fire. 	
	<ul style="list-style-type: none"> ● Please contact your agent if you need to remove and reinstall the unit. Electric shock or fire may occur if you remove and reinstall the unit yourself improperly. 	

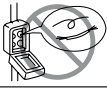
PRECAUTIONS DURING OPERATION

WARNING	<ul style="list-style-type: none"> ● Avoid an extended period of direct air flow for your health. 	
	<ul style="list-style-type: none"> ● Do not insert a finger, a rod or other objects into the air outlet or inlet. As the fan is rotating at a high speed, it will cause injury. Before cleaning, be sure to stop the operation and turn the breaker OFF. 	
	<ul style="list-style-type: none"> ● Do not use any conductor as fuse wire, this could cause fatal accident. 	
	<ul style="list-style-type: none"> ● During thunder storm, disconnect and turn off the circuit breaker. 	

- The product shall be operated under the manufacturer specification and not for any other intended use.

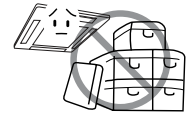

- Do not attempt to operate the unit with wet hands, this could cause fatal accident.

- When operating the unit with burning equipments, regularly ventilate the room to avoid oxygen insufficiency.

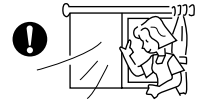

- Do not direct the cool air coming out from the air-conditioner panel to face household heating apparatus as this may affect the working of apparatus such as the electric kettle, oven etc.

- Please ensure that outdoor mounting frame is always stable, firm and without defect. If not, the outdoor unit may collapse and cause danger.



- Do not splash or direct water to the body of the unit when cleaning it as this may cause short circuit.

- Do not use any aerosol or hair sprays near the indoor unit. This chemical can adhere on heat exchanger fin and blocked the evaporation water flow to drain pan. The water will drop on tangential fan and cause water splashing out from indoor unit.



- Please switch off the unit and turn off the circuit breaker during cleaning, the high-speed fan inside the unit may cause danger.



- Turn off the circuit breaker if the unit is not to be operated for a long period.

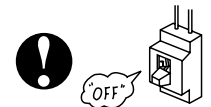

- Do not climb on the outdoor unit or put objects on it.

- When operating the unit with the door and windows opened, (the room humidity is always above 80%) and with the air deflector facing down or moving automatically for a long period of time, water will condense on the air deflector and drips down occasionally. This will wet your furniture. Therefore, do not operate under such condition for a long time.

- If the amount of heat in the room is above the cooling or heating capability of the unit (for example: more people entering the room, using heating equipments and etc.), the preset room temperature cannot be achieved.

- This appliance is not intended for use by young children or infirm persons unless they have been adequately supervised by a responsible person to ensure that they can use the appliance safely.
- Young children should be supervised to ensure that they do not play with the appliance.



C
A
U
T
I
O
N

NAMES AND FUNCTIONS OF EACH PART

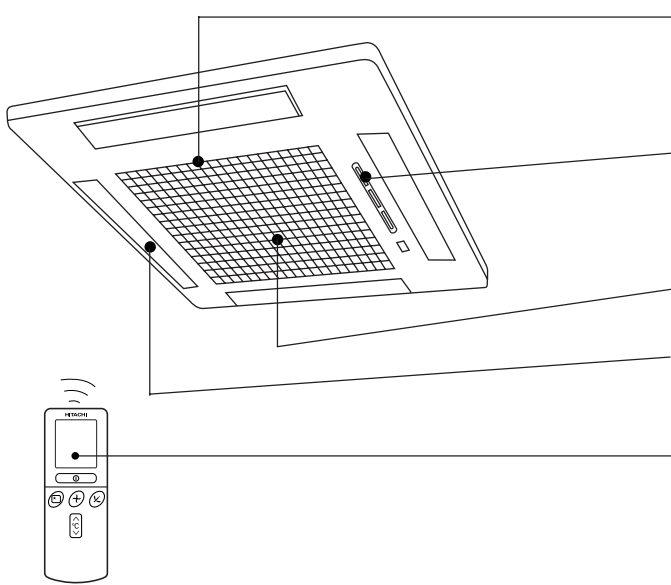

AIR FILTER

To prevent dust from coming into the indoor unit.
(Refer page 23)

INDOOR UNIT INDICATORS

Light indicator showing the operating condition.
(Refer page 9)

SUCTION GRILL (AIR INLET)

HORIZONTAL DEFLECTOR (AIR OUTLET)

(Refer page 19)

REMOTE CONTROL

Send out operation signal to the indoor unit. So as to operate the whole unit.
(Refer page 10)

MODEL NAME AND DIMENSIONS

MODEL	WIDTH (mm)	HEIGHT (mm)	DEPTH (mm)
RAI-25NH5 / RAI-35NH5	580	285	580

MULTI-AIR CONDITIONER

With this multi-air conditioner, several indoor units can be connected to one outdoor unit to be driven. You can operate the required number of indoor units.

Combination of Operations:

When operation mode is selected:

- You cannot operate the indoor units in the following combinations.

One unit	Other unit
Heating	Cooling
	Dehumidifying
	Circulating (fan)

- The indoor unit which is switched on first continues to operate, but other indoor units which is switched on later does not operate while the lamp lights.
- To re-start an indoor unit which was operated later, stop the indoor unit which was operated first or later and reset the type of operation, then perform operation again.

During automatic operation:

- When heating operation is automatically selected for the first indoor unit, the next indoor unit will then start to heat. Also, if cooling or dehumidifying is automatically selected for the first indoor unit, the next indoor unit will also start to cool or dehumidify.

Adjusting the Number of Indoor Units:

Decrease the number of indoor units to be operated especially when it is very hot or cold or when you want to reach the present temperature quickly.

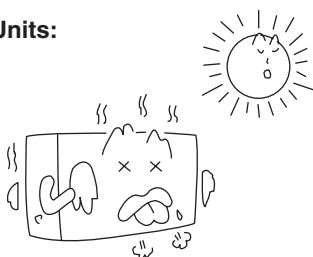

Stopped Indoor Units:

When an indoor unit is operated in the cooling, heating or dehumidifying mode in the room, the sound of refrigerant flow may be heard from a stopped indoor unit or a stopped indoor unit may become warm. This is because the indoor unit returns refrigerant to the outdoor unit to be ready for operation.

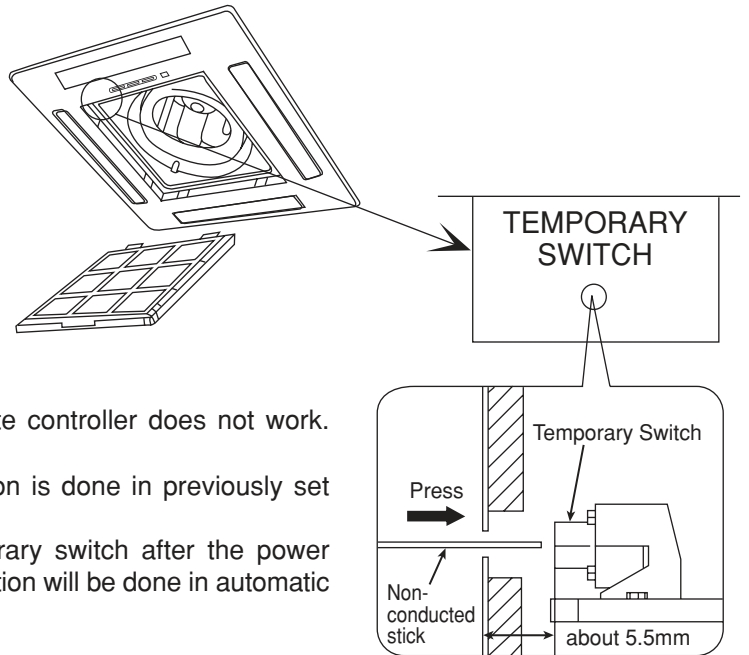
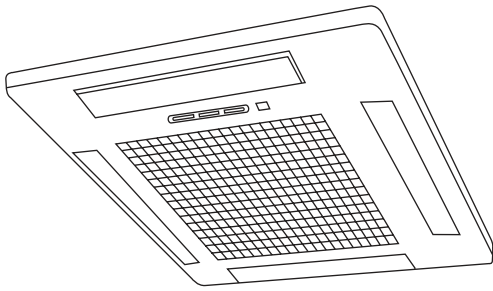

TEMPORARY SWITCH

Use this switch to start and stop when the remote controller does not work.
 [Use non-conductor stick (example toothpick)]

- By pressing the temporary switch, the operation is done in previously set operation mode.
- When the operation is done using the temporary switch after the power source is turned off and turn on again, the operation will be done in automatic mode.

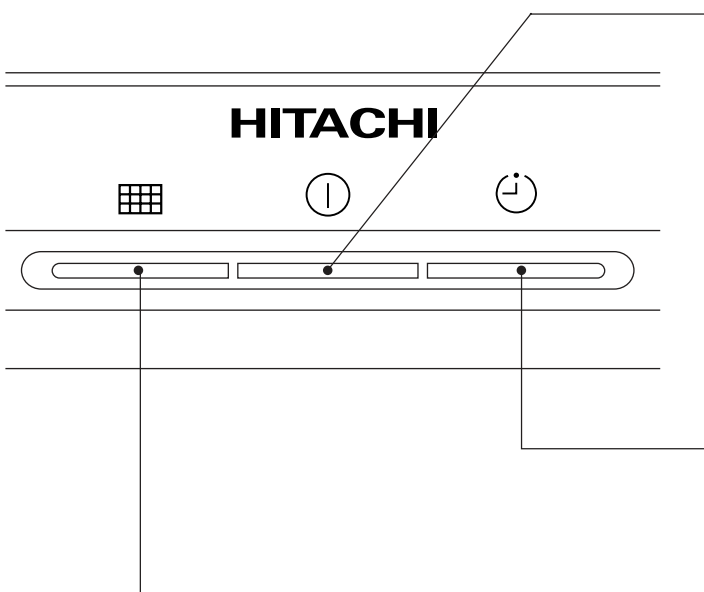

OPERATION LAMP

This lamp lights during operation.

The OPERATION LAMP flashes in the following cases during heating.

(1) During preheating

For about 2–3 minutes after starting up.

(2) During defrosting

Defrosting will be performed about once an hour when frost forms on the heat exchanger of the outdoor unit, for 5–10 minutes each time.

TIMER LAMP

This lamp lights when the timer is working.

FILTER LAMP

When the device is operated for a total of about 200 hours, the FILTER lamp lights to indicate that it is time to clean the filter. The lamp goes out when the “ (AUTO SWING)” button is pressed while the device is on “STANDBY MODE”.

NAMES AND FUNCTIONS OF REMOTE CONTROL UNIT

REMOTE CONTROLLER

- Operate by pointing towards the signal receptor on the indoor unit. The range of control is about 7 meters. Signal receivable angle range is approximately 70°. However, if there is an electronic light sensor device (inverter) in the room, signal may not be received or receivable distance may become shorter.
- Indoor unit must be install 1 meter or more away from lighting.
- Handle the remote controller with care. Dropping it or getting it wet may compromise its signal transmission capability.
- After new batteries are inserted into the remote controller, the unit will initially require approximately 10 seconds to respond to commands and operate.

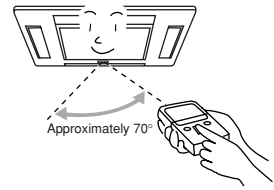

- **Signal emitting window/transmission sign**
Point this window toward the indoor unit when controlling it. The transmission sign blinks when a signal is sent.
- **Display**
This indicates the room temperature selected, current time, timer status, function and intensity of circulation selected.
- **START/STOP button**
Press this button to start operation. Press it again to stop operation.
- **SLEEP button**
Use this button to set the sleep timer.
- **TEMPERATURE buttons**
Use these buttons to raise or lower the temperature setting. (Keep pressed, and the value will change more quickly.)
- **TIME button**
Use this button to set and check the time and date.
- **RESET buttons**
- **FUNCTION selector**
Use this button to select the operating mode. Every time you press it, the mode will change from (AUTO) to (HEAT) to (DEHUMIDIFY) to (COOL) and to (FAN) cyclically.
- **FAN SPEED selector**
This determines the fan speed. Every time you press this button, the intensity of circulation will change from (AUTO) to (HI) to (MED) to (LOW) (This button allows selecting the optimal or preferred fan speed for each operation mode).
- **AUTO SWING button**
Controls the angle of the horizontal air deflector.
- **TIMER control**
Use this button to set the timer.
- **OFF-TIMER button** Select the turn OFF time.
- **ON-TIMER button** Select the turn ON time.
- **RESERVE button** Time setting reservation.
- **CANCEL button** Cancel time reservation.

	AUTO
	HEAT
	DEHUMIDIFY
	COOL
	FAN
	FAN SPEED LOW MED HI
	SLEEPING
	STOP (CANCEL)
	START (RESERVE)
	START/STOP
	TIME
	TIMER SET
	TIMER SELECTOR ON TIMER OFF TIMER
	AUTO SWING

Precautions for Use

- Do not put the remote controller in the following places.
 - Under direct sunlight.
 - In the vicinity of a heater.
- Handle the remote controller carefully. Do not drop it on the floor, and protect it from water.
- Once the outdoor unit stops, it will not restart for about 3 minutes (unless you turn the power switch off and on or unplug the power cord and plug it in again).
This is to protect the device and does not indicate a failure.
- If you press the FUNCTION selector button during operation, the device may stop for about 3 minutes for protection.

VARIOUS FUNCTIONS

- If there is a power failure, operation will be automatically restarted when the power is resumed with previous operation mode and airflow direction.
(As the operation is not stopped by remote controller.)
- If you intend not to continue the operation when the power is resumed, switch off the power supply.
When you switch on the circuit breaker, the operation will be automatically restarted with previous operation mode and airflow direction.

Note: 1. If you do not require Auto Restart Control, please consult your sales agent or OFF by remote control.
2. Auto Restart Control is not available when Timer or Sleep Timer mode is set.

AUTOMATIC OPERATION

The device will automatically determine the mode of operation, HEAT, COOL or DEHUMIDIFY depending on the current room temperature. The selected mode of operation will change when the room temperature varies. However the mode of operation will not change when indoor unit connected to multi type outdoor unit.

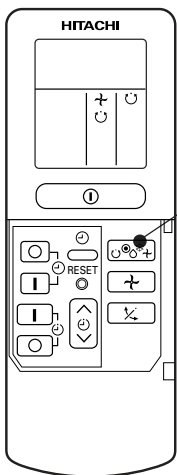



1

Press the FUNCTION selector so that the display indicates the  (AUTO) mode of operation.

- When AUTO has been selected, the device will automatically determine the mode of operation, HEAT, COOL or DEHUMIDIFY depending on the current room temperature. However the mode of operation will not change when indoor unit connected to multi type outdoor unit.
- If the mode automatically selected by the unit is not satisfactory, manually change the mode setting (heat, dehumidify, cool or fan).

START STOP

Press the  (START/STOP) button.
Operation starts with a beep.
Press the button again to stop operation.

- As the settings are stored in memory in the remote controller, you only have to press the  (START/STOP) button next time.

You can raise or lower the temperature setting as necessary by maximum of 3°C.

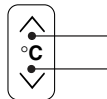

Press the temperature button and the temperature setting will change by 1°C each time.

- The preset temperature and the actual room temperature may vary somewhat depending on conditions.
- The display does not indicate the preset temperature in the AUTO mode. If you change the setting, the indoor unit will produce a beep.

Press the  (FAN SPEED) button, AUTO and LOW is available.

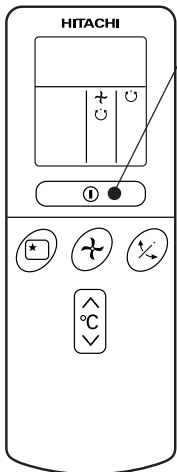

HEATING OPERATION

- Use the device for heating when the outdoor temperature is under 21°C.
When it is too warm (over 21°C), the heating function may not work in order to protect the device.
- In order to keep reliability of the device, please use this device above -15°C of the outdoor temperature.

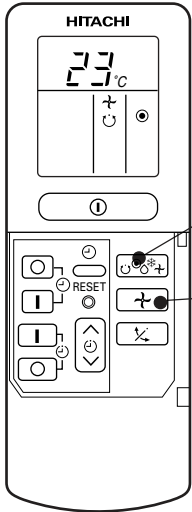

1

Press the FUNCTION selector so that the display indicates ● (HEAT).

2

Set the desired FAN SPEED with the ↻ (FAN SPEED) button (the display indicates the setting).

↻ (AUTO): The fan speed is HI at first and varies to MED or LOW automatically when the preset temperature has been reached.

⏏ (HI) : Economical as the room will become warm quickly.
But you may feel a chill at the beginning.

⏏ (MED) : Fan speed slow.

⏏ (LOW) : Fan speed slower.

3

Set the desired room temperature with the TEMPERATURE buttons (the display indicates the setting).

The temperature setting and the actual room temperature may vary somewhat depending on conditions.

**START
STOP**

Press the ⏏ (START/STOP) button. Heating operation starts with a beep. Press the button again to stop operation.

- As the settings are stored in memory in the remote controller, you only have to press the ⏏ (START/STOP) button next time.

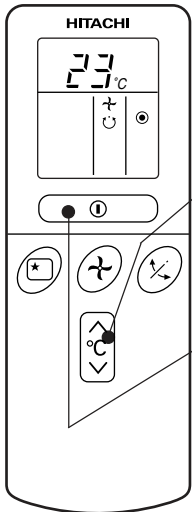

DEHUMIDIFYING OPERATION

Use the device for dehumidifying when the room temperature is over 16°C.
When it is under 15°C, the dehumidifying function will not work.

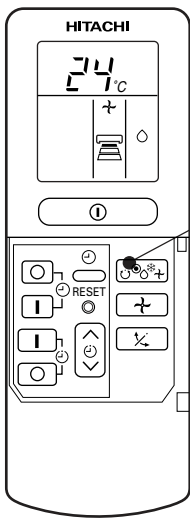

1

Press the FUNCTION selector so that the display indicates ◊ (DEHUMIDIFY).
The FAN SPEED is set at LOW automatically.
The FAN SPEED button does not work.

2

Set the desired room temperature with the TEMPERATURE button (the display indicates the setting).



The range of 20-26°C is recommended as the room temperature for dehumidifying.

**START
STOP**

Press the Ⓜ (START/STOP) button. Dehumidifying operation starts with a beep. Press the button again to stop operation.

- As the settings are stored in memory in the remote controller, you only have to press the Ⓜ (START/STOP) button next time.

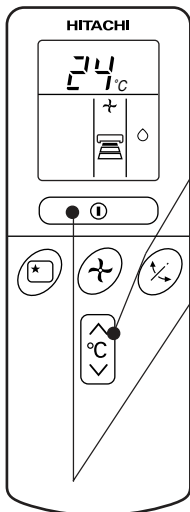

When the room temperature is higher than the temperature setting: The device will dehumidify the room, reducing the room temperature to the preset level.
When the room temperature is lower than the temperature setting: Dehumidifying will be performed at the temperature setting slightly lower than the current room temperature, regardless of the temperature setting. The function will stop (the indoor unit will stop emitting air) as soon as the room temperature becomes lower than the setting temperature.

COOLING OPERATION

Use the device for cooling when the outdoor temperature is 22-42°C.
If in doors humidity is very high (80%), some dew may form on the air outlet grille of the indoor unit.

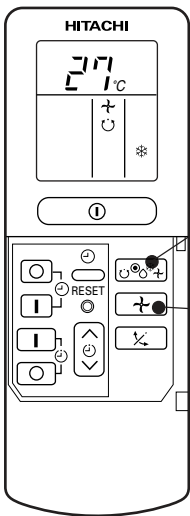

1

Press the FUNCTION selector so that the display indicates * (COOL).

2

Set the desired FAN SPEED with the \updownarrow (FAN SPEED) button (the display indicates the setting).

\updownarrow (AUTO): The FAN SPEED is HI at first and varies to MED or LOW automatically when the preset temperature has been reached.

 (HI) : Economical as the room will become cool quickly.

 (MED) : Fan speed slow.

 (LOW) : Fan speed slower.

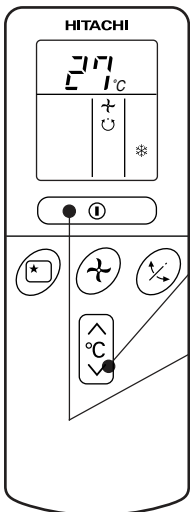

3

Set the desired room temperature with the TEMPERATURE button (the display indicates the setting).

The temperature setting and the actual room temperature may vary some how depending on conditions.

**START
STOP**

Press the O (START/STOP) button. Cooling operation starts with a beep. Press the button again to stop operation. The cooling function does not start if the temperature setting is higher than the current room temperature (even though the O (OPERATION) lamp lights). The cooling function will start as soon as you set the temperature below the current room temperature.

■ As the settings are stored in memory in the remote controller, you only have to press the O (START/STOP) button next time.

FAN OPERATION

You can use the device simply as an air circulator. Use this function to dry the interior of the indoor unit at the end of summer.

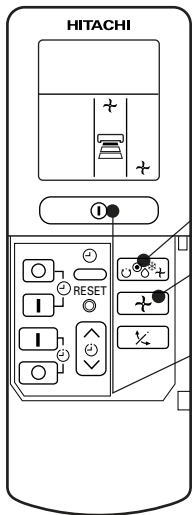

1

Press the FUNCTION selector so that the display indicates (FAN).

2

Press the (FAN SPEED) button.

**START
STOP**

Press the (START/STOP) button. Fan operation starts with a beep. Press the button again to stop operation.

..... When the AUTO fan speed mode is set in the cooling/heating operation:

For the heating operation	<ul style="list-style-type: none"> ● The fan speed will automatically change according to the temperature of discharged air. ● When the difference of room temperature and setting temperature is large, fan starts to run at HI speed. ● When the room temperature reaches setting temperature, fan speed changes to LOW automatically.
For the cooling operation	<ul style="list-style-type: none"> ● When the difference of room temperature and setting temperature is large, fan starts to run at HI speed. ● After room temperature reaches the preset temperature, the cooling operation, which changes the fan speed and room temperature to obtain optimum conditions for natural healthful cooling will be performed.

HOW TO SET THE TIMER

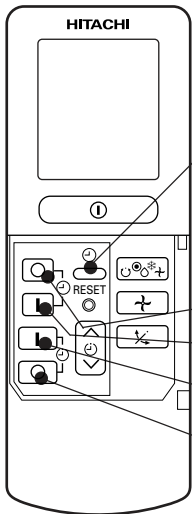

Time, Day, Month

After you change the batteries;

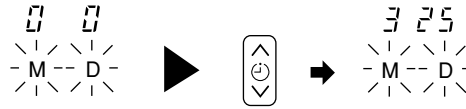

1 Set the current month and day with the TIMER control button.

OFF-Timer

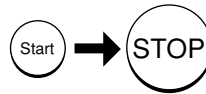

1 Press the (OFF-TIMER) button. The (OFF) mark blinks on the display.

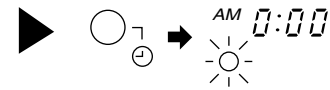

You can set the device to turn off at the present time.

ON-Timer

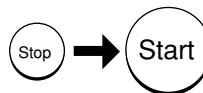

- The device will turn on at the designated times.

1 Press the (ON-TIMER) button the (ON) mark blinks on the display.

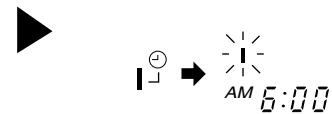

ON/OFF-Timer

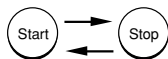

- The device will turn on (off) and off (on) at the designated times.
- The switching occurs first at the preset time that comes earlier.
- The arrow mark appearing on the display indicates the sequence of switching operations.

1 Press the (ON-OFF) button so that the (OFF) mark blinks.

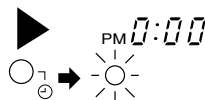

2 Set the turn-off time with the TIMER control button. Press the (RESERVE) button.

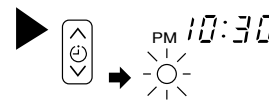

3 Press the (ON-TIMER) button so that the (OFF) mark lights and the (ON) mark blinks.

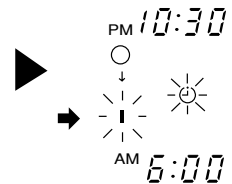

How to Cancel Reservation

Point the signal window of the remote controller toward the indoor unit, and press the (CANCEL) button.

The (RESERVED) sign goes out with a beep and the (TIMER) lamp turns off on the indoor unit.

NOTE

You can set only one of the OFF-timer, ON-timer and ON/OFF-timer.

2 Press the  (TIME) button.

3 Set the current time with the TIMER control button.

4 Press the  (TIME) button again. The time indication starts lighting instead of flashing.

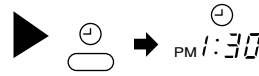
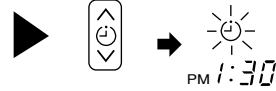
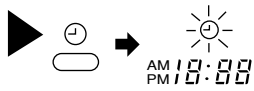



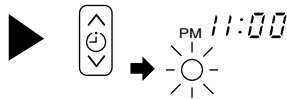

Example: The current time is 1:30 p.m.

- The time indication will disappear automatically in 10 second.
 - To check the current time setting, press the  (TIME) button twice.
- The setting of the current time is now complete.

2 Set the turn-off time with the TIMER control button.



3 Point the signal window of the remote controller toward the indoor unit, and press the  (RESERVE) button. The  (OFF) mark starts lighting instead of flashing and the sign  (RESERVED) lights. A beep occurs and the  (TIMER) lamp lights on the indoor unit.

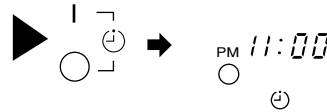





Example: The device will turn off at 11:00p.m.

The setting of turn-off time is now complete.

2 Set the turn-on time with the TIMER control button.





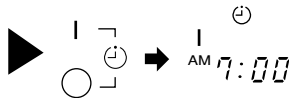

3 Point the signal window of the remote controller toward the indoor unit, and press the  (RESERVE) button. The  (ON) mark starts lighting instead of flashing and the  (RESERVED) sign lights. A beep occurs and the  (TIMER) lamp lights on the indoor unit.

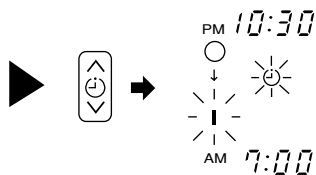

Example:
The device will turn on at 7:00 a.m.
The setting of the turn-on time is now complete.

4 Set the turn-on time with the TIMER control button.



5 Point the signal window of the remote controller toward the indoor unit, and press the  (RESERVE) button. The  (ON) mark starts lighting instead of flashing and the  (RESERVED) sign lights. A beep occurs and the  (TIMER) lamp lights on the indoor unit.

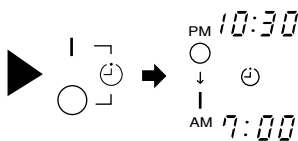

Example:
The device will turn off at 10:30 p.m. and it will be turned on at 7:00 a.m.
The settings of the turn-on/off times are now complete.

- The timer may be used in three ways: off-timer, on-timer, and ON/OFF (OFF/ON)-timer. Set the current time at first because it serves as a reference.
- As the time settings are stored in memory in the remote controller, you only have to press the  (RESERVE) button in order to use the same settings next time.

HOW TO SET THE SLEEP TIMER

Set the current time at first if it is not set before (see the pages for setting the current time). Press the  (SLEEP) button, and the display changes as shown below.

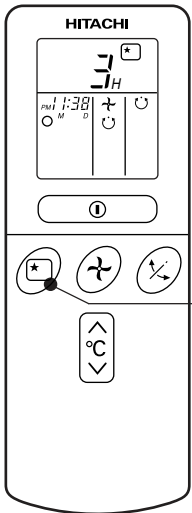

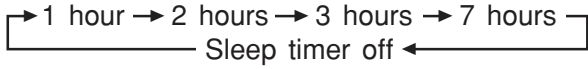
Mode	Indication
Sleep timer	

Sleep Timer: The device will continue working for the designated number of hours and then turn off. Point the signal window of the remote controller toward the indoor unit, and press the SLEEP button. The timer information will be displayed on the remote controller. The TIMER lamp lights with a beep from the indoor unit. When the sleep timer has been set, the display indicates the turn-off time.

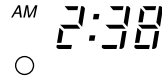

Example: If you set 3 hours sleep time at 11:38 p.m., the turn-off time is 2:38 a.m.

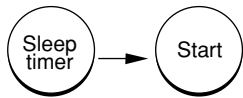

The device will be turned off by the sleep timer and turned on by on-timer.

1 Set the ON-timer.

2 Press the  (SLEEP) button and set the sleep timer.

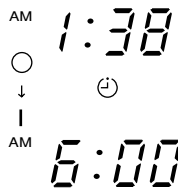
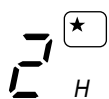

For heating:

In this case, the device will turn off in 2 hours (at 1:38 a.m.) and turn on early so that the preset temperature will be almost reached at 6:00 next morning.

How to Cancel Reservation

Point the signal window of the remote controller toward the indoor unit, and press the  (CANCEL) button.

The  (RESERVED) sign goes out with a beep and the  (TIMER) lamp turns off on the indoor unit.



ADJUSTING THE AIR DEFLECTOR

1

Adjustment of the conditioned air in the upward and downward directions.

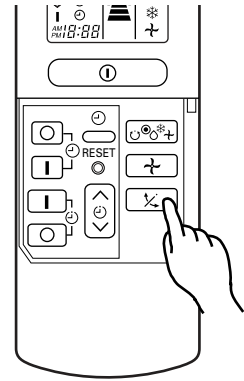
According to “Dehumidifying” or “Cooling” operation, the horizontal air deflector is automatically set to the proper angle suitable for each operation. The deflector can be swung up and down and also set to the desired angle using the “ (AUTO SWING)” button. (If the angle of the deflector is changed, it will not return to the auto-set position after operations start unless the operation mode is switched.)



- If the “ (AUTO SWING)” button is pressed once, the horizontal air deflector swings up and down. If the button is pressed again, the deflector stops in its current position. Several seconds (about 6 seconds) may be required before the deflector starts to move.
- Use the horizontal air deflector within the adjusting range shown on the right.
- When the “ (AUTO SWING)” button is pressed while the operation is stopped, the horizontal air deflector moves and stops at the position where the air outlet closes.
- When the auto swing operation is performed, if the horizontal air deflector is moved manually, the swinging range may drift. However, it will return to the original operation range after a short time.

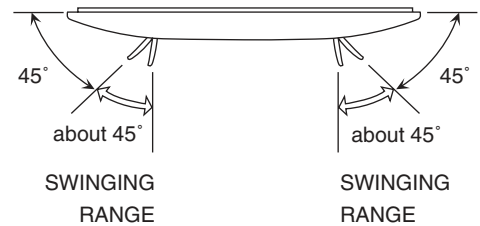

⚠ CAUTION

When operating the unit in cooling operation with the air deflector facing down and moving automatically for a long period of time, water will condensed on the air deflector and drips down occasionally. This will wet your furniture.

HOW TO EXCHANGE THE BATTERIES IN THE REMOTE CONTROLLER

1 Remove the cover as shown in the figure and take out the old batteries.



2 Install the new batteries.
The direction of the batteries should match the marks in the case.

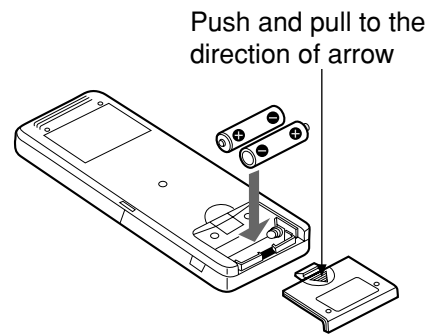

⚠ CAUTION

1. Do not use new and old batteries, or different kinds of batteries together.
2. Take out the batteries when you do not use the remote controller for 2 or 3 months.

THE IDEAL WAYS OF OPERATION

Suitable Room Temperature

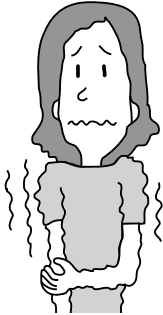

⚠ Warning
Freezing temperature is bad for health and a waste of electric power.

Install curtain or blinds

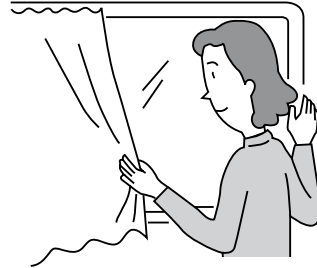

It is possible to reduce heat entering the room through windows.

Ventilation

⚠ Caution
Do not close the room for a long period of time. Occasionally open the door and windows to allow the entrance of fresh air.



Effective Usage Of Timer

At night, please use the “OFF or ON timer operation mode”, together with your wake up time in the morning. This will enable you to enjoy a comfortable room temperature. Please use the timer effectively.

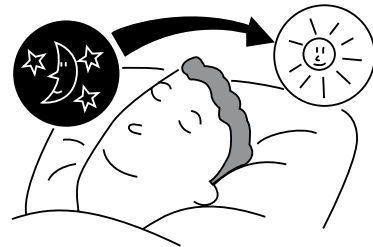

Do Not Forget To Clean The Air Filter

Dusty air filter will reduce the air volume and the cooling efficiency. To prevent from wasting electric energy, please clean the filter every 2 weeks.

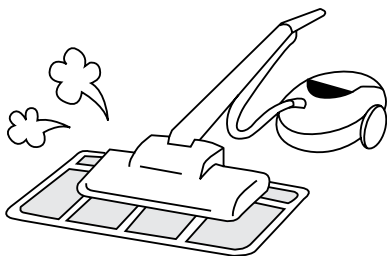

Please Adjust Suitable Temperature For Baby And Children

Please pay attention to the room temperature and air flow direction when operating the unit for baby, children and old folks who have difficulty in movement.

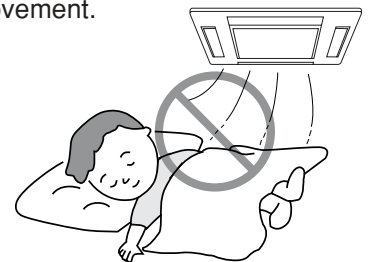

FOR USER'S INFORMATION

The Air Conditioner And The Heat Source In The Room

⚠ Caution

If the amount of heat in the room is above the cooling capability of the air conditioner (for example: more people entering the room, using heating equipments and etc.), the preset room temperature cannot be achieved.



Not Operating For A Long Time

When the indoor unit is not to be used for a long period of time, please switch off the power from the mains. If the power from mains remains "ON", the indoor unit still consumes about 8W in the operation control circuit even if it is in "OFF" mode.

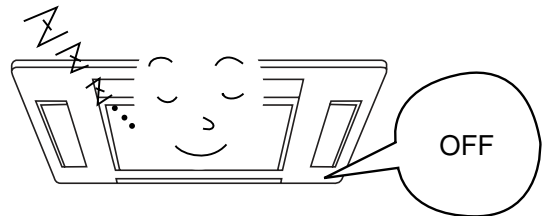

When Lightning Occurs

⚠ Warning

To protect the whole unit during lightning, please stop operating the unit and remove the plug from the socket.



Interference From Electrical Products

⚠ Caution

To avoid noise interference, please place the indoor unit and its remote controller at least 1m away from electrical products.

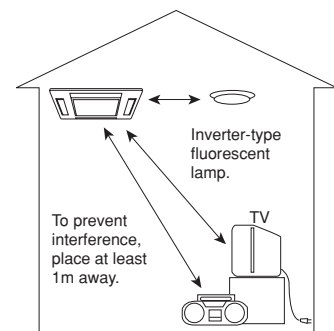

MAINTENANCE

▲ CAUTION

Cleaning and maintenance must be carried out by qualified service personnel.
Before the cleaning, stop operation and disconnect the power supply.
Clean the filter at least once every one month. This helps save electricity cost.

1. CLEANING OF AIR FILTER

PROCEDURE

- 1** Remove the filter from indoor
 - Press the mark “PUSH” on the left and right sides of the suction grille.
 - Pull out the filter from the grille.
- 2** Remove dust from the filter using a vacuum cleaner.
If there is too much dust, use neutral detergent. After using neutral detergent, wash with clean water and dry in the shade.
- 3** Install the filter. (Set it with “UP SIDE” mark facing front.)
Slot the filter to suction grille and close as original state.
(Press the mark “PUSH” at the left and right sides of the suction grille to fix it securely.)

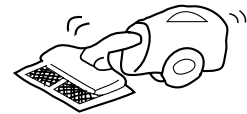
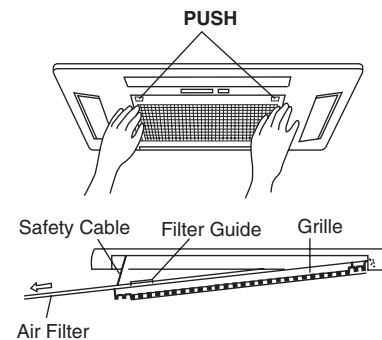

Note:

- This model has an air cleaning filter. The cooling capacity is slightly weakened and the cooling speed becomes slower when the air cleaning filter is used. So, set the fan speed to “HIGH” when using it in this condition.
- Recommended to replace the air cleaning filter after every 3 months for normal usage. Type number for this air cleaning filter is <SPX-CFH5>. Please use this number for ordering when you want to renew it.

▲ CAUTION

- Do not wash with hot water at more than 40°C. The filter may shrink.
- When washing it, shake off moisture completely and dry it in the shade; do not expose it directly to the sun. The filter may shrink.
- Do not operate the air conditioner with the filter removed. Dust may enter the air conditioner and cause trouble.

2. CLEANING OF FRONT PANEL

- Wipe it with a soft dry cloth.
- When it is excessively dirty, wipe with soft cloth soaked in lukewarm water or neutral detergent. Then wipe thoroughly with a soft dry cloth.

⚠ CAUTION

- Do not splash or direct water to the body of the unit when cleaning it as this may cause short circuit.
- Never use hot water (above 40°C), benzine, gasoline, acid, thinner or a brush, because they will damage the plastic surface and the coating.



3. MAINTENANCE AT BEGINNING OF LONG OFF PERIOD

- Running the unit setting the operation mode to ↻ (FAN) and the fan speed to HI for about half a day on a fine day, and dry the whole of the unit.
- Turn off the circuit breaker.

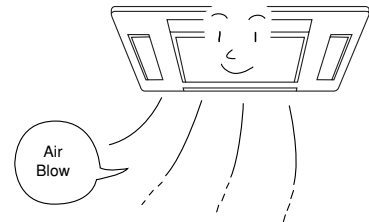

REGULAR INSPECTION

PLEASE CHECK THE FOLLOWING POINTS EITHER EVERY HALF YEARLY OR YEARLY. CONTACT YOUR SALES AGENT SHOULD YOU NEED ANY HELP.

1		<p>Is the earth line disconnected or broken?</p> <p>⚠ WARNING Coming off or breakage of grounding wire may cause malfunction or electrical shock.</p>
2		<p>Is the mounting frame seriously affected by rust and is the outdoor unit tilted or unstable?</p> <p>⚠ WARNING Outdoor unit may fall or drop if there is extreme rust on mounting frame or outdoor unit is unstably installed. This may cause injury.</p>
3		<p>Is the plug of power line firmly plugged into the socket? (Please ensure no loose contact between them).</p>

AFTER SALES SERVICE AND WARRANTY

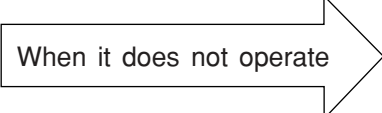
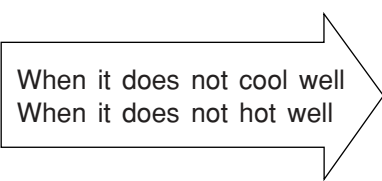
CONDITION	CHECK THE FOLLOWING POINTS
 <p>When it does not operate</p>	<ul style="list-style-type: none"> ● Is the fuse blown out or the circuit breaker tripped? ● Is the voltage normal? ● Is the circuit breaker "ON"?
 <p>When it does not cool well When it does not hot well</p>	<ul style="list-style-type: none"> ● Is the air filter blocked with dust? ● Does sunlight fall directly on the outdoor unit? ● Is the air flow of the outdoor unit obstructed? ● Are the doors or windows opened, or is there any source of heat in the room? ● Is the set temperature suitable?



Notes

- In quiet operation or stopping the running, the following phenomena may occasionally occur, but they are not abnormal for the operation.
 - (1) Slight flowing noise of refrigerant in the refrigerating cycle.
 - (2) Slight rubbing noise from the fan casing which is cooled and then gradually warmed as operation stops.
- The odor will possibly be emitted from the room air conditioner because the various odor, emitted by smoke, foodstuffs, cosmetics and so on, sticks to it. So please clean the air filter and the evaporator regularly to reduce the odor.

- Please contact your sales agent immediately if the air conditioner still fails to operate normally after the above inspections. Inform your agent of the model of your unit, production number, date of installation. Please also inform him regarding the fault.
- Power supply shall be connected at the rated voltage, otherwise the unit will be broken or could not reach the specified capacity.

CONSTRUCTION AND DIMENSIONAL DIAGRAM

MODEL RAI-25NH5, RAI-35NH5

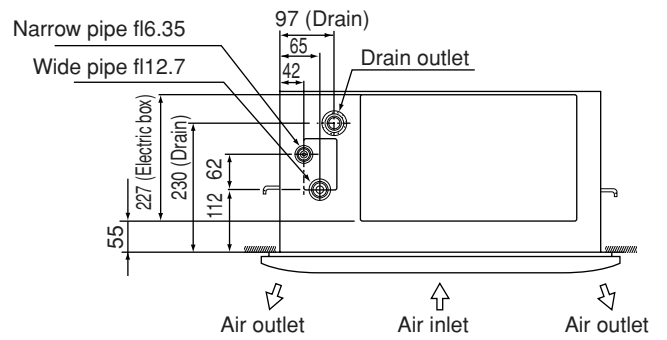
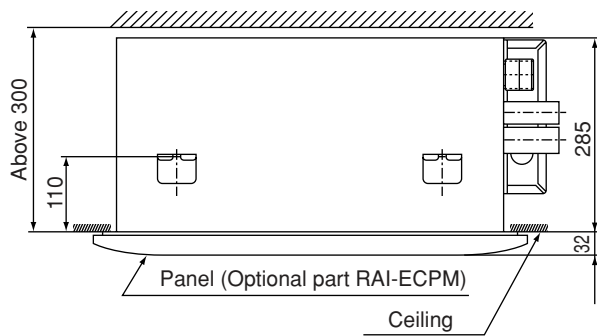
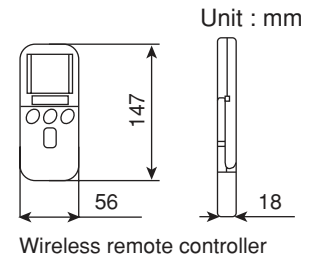
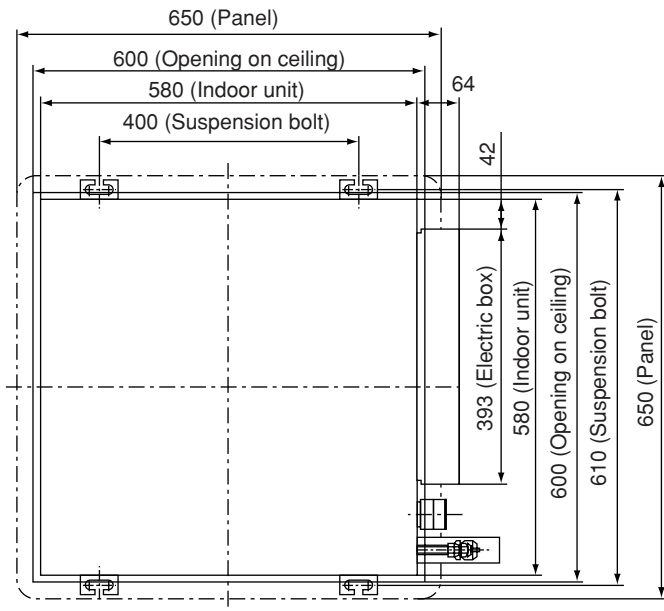

Note:

1. Insulated pipes should be used for both the narrow and wide dia. pipes.
2. Piping length is within 20m.
3. Height difference of the piping between the indoor unit and the outdoor unit should be within 10m.
4. An F-cable 1.6mm or 2.0mm dia. X 3 (control side) is used for the connection cable.

MAIN PARTS COMPONENT

THERMOSTAT

Thermostat Specifications

THERMOSTAT MODEL			IC		
OPERATION MODE			COOL		HEAT
MODEL			RAI-25NH5	RAI-35NH5	RAI-25NH5, RAI-35NH5
TEMPERATURE °C (°F)	INDICATION 16	ON	15.0 (59.0)	13.0 (55.4)	20.0 (68.0)
		OFF	14.7 (58.5)	12.7 (54.9)	20.3 (68.5)
	INDICATION 24	ON	23.0 (73.4)	21.0 (69.8)	28.0 (82.4)
		OFF	22.7 (72.9)	20.7 (69.3)	28.3 (82.9)
	INDICATION 32	ON	31.0 (87.8)	29.0 (84.2)	36.0 (96.8)
		OFF	30.7 (87.3)	28.7 (83.7)	36.3 (97.9)

FAN MOTOR

Fan Motor Specifications

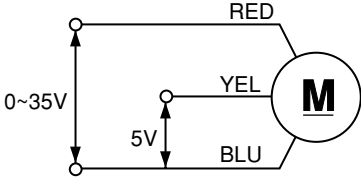
MODEL	RAI-25NH5 RAI-35NH5
POWER SOURCE	DC: 0 ~ 35V
OUTPUT	25W
CONNECTION	 <p>(Control circuit built in)</p>

BLU : BLUE

YEL : YELLOW

BRN : BROWN

WHT : WHITE

GRY : GRAY

ORN : ORANGE

GRN : GREEN

RED : RED

BLK : BLACK

PNK : PINK

VIO : VIOLET

WIRING DIAGRAM

MODEL RAI-25NH5 / RAI-35NH5

INDOOR UNIT

- 29 -

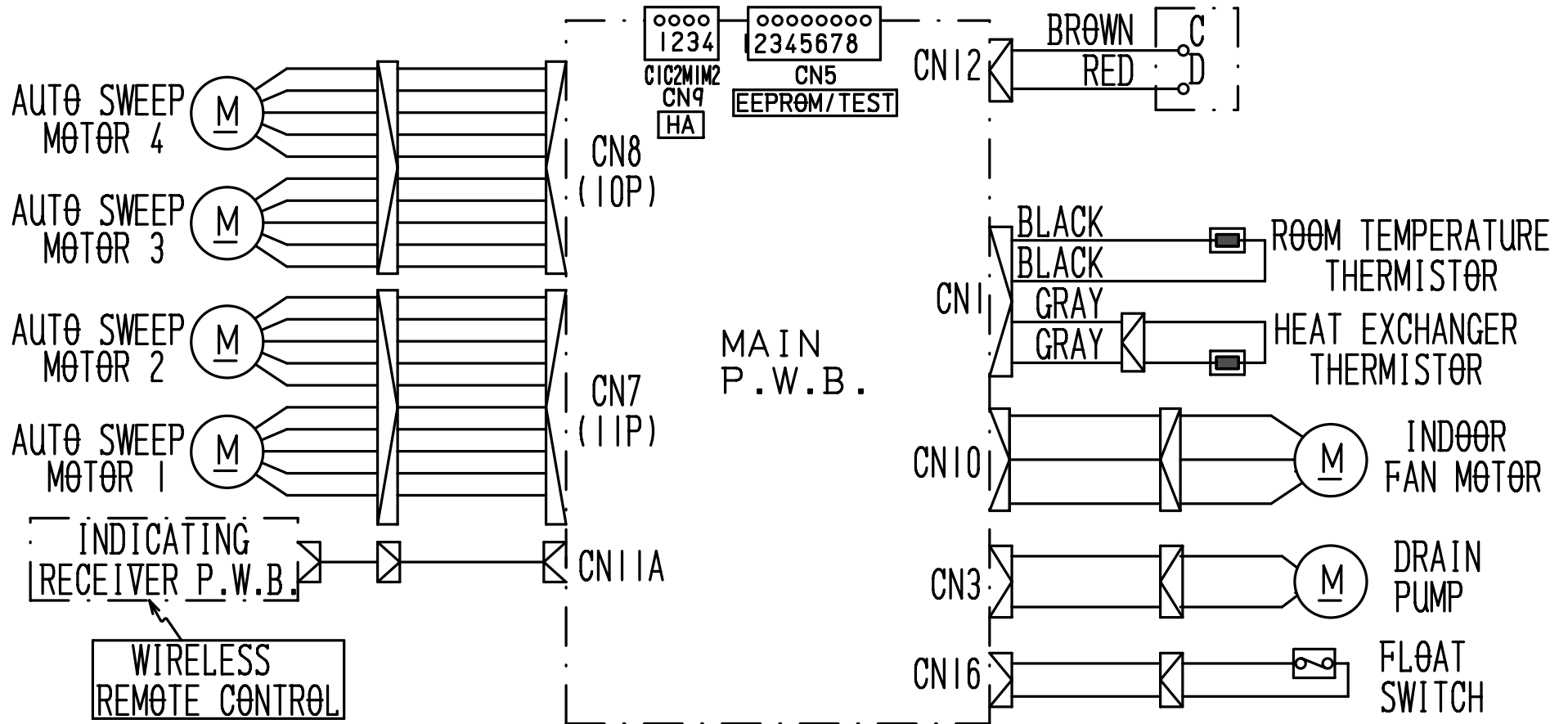

CIRCUIT DIAGRAM

Remote Control

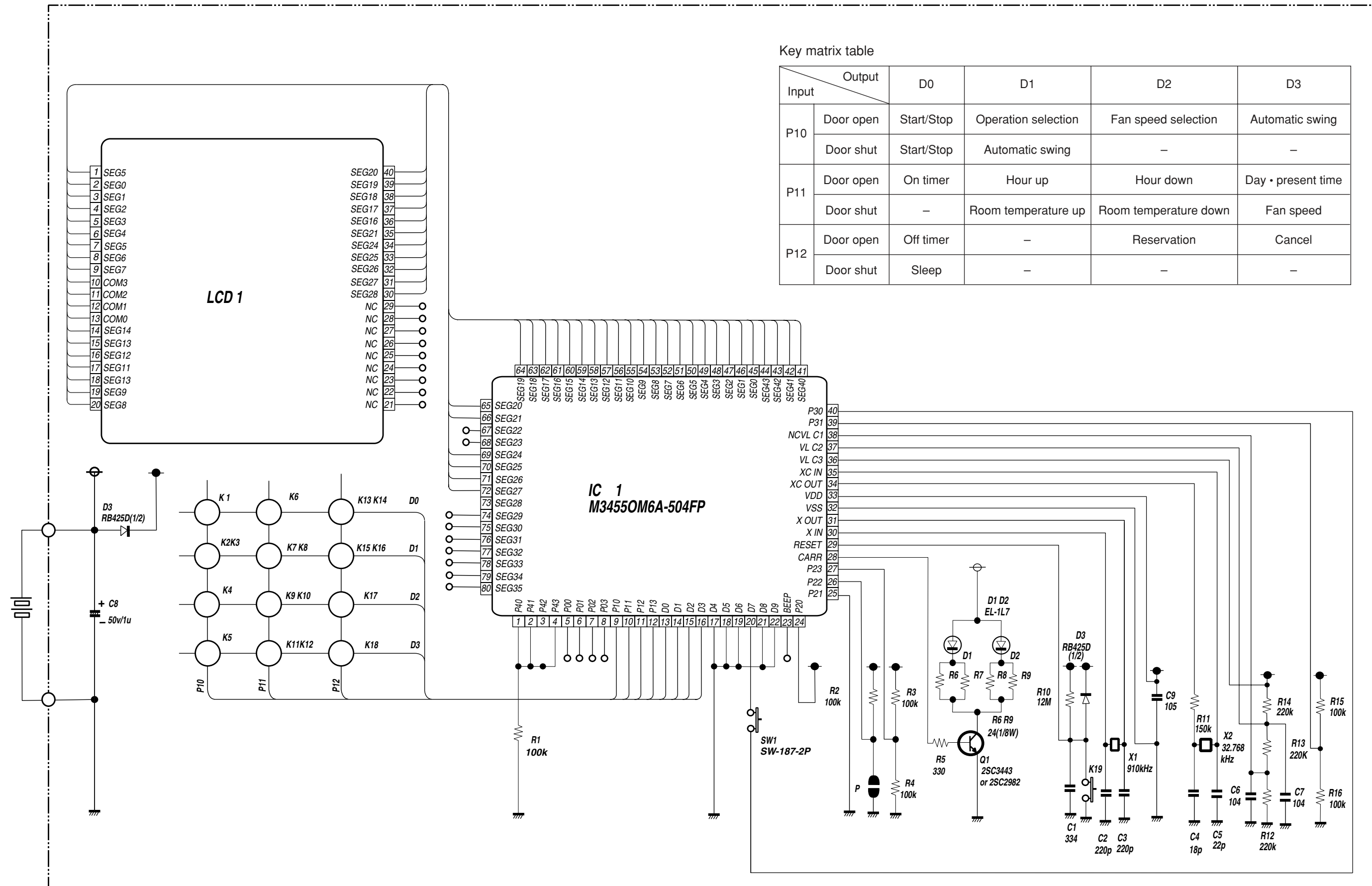

Key matrix table

Input \ Output		D0	D1	D2	D3
		D0	D1	D2	D3
P10	Door open	Start/Stop	Operation selection	Fan speed selection	Automatic swing
	Door shut	Start/Stop	Automatic swing	-	-
P11	Door open	On timer	Hour up	Hour down	Day · present time
	Door shut	-	Room temperature up	Room temperature down	Fan speed
P12	Door open	Off timer	-	Reservation	Cancel
	Door shut	Sleep	-	-	-

PRINTED WIRING BOARD LOCATION DIAGRAM

MODEL RAI-25NH5, RAI-35NH5

MAIN P.W.B.

Marking on P.W.B.

COMPONENT SIDE

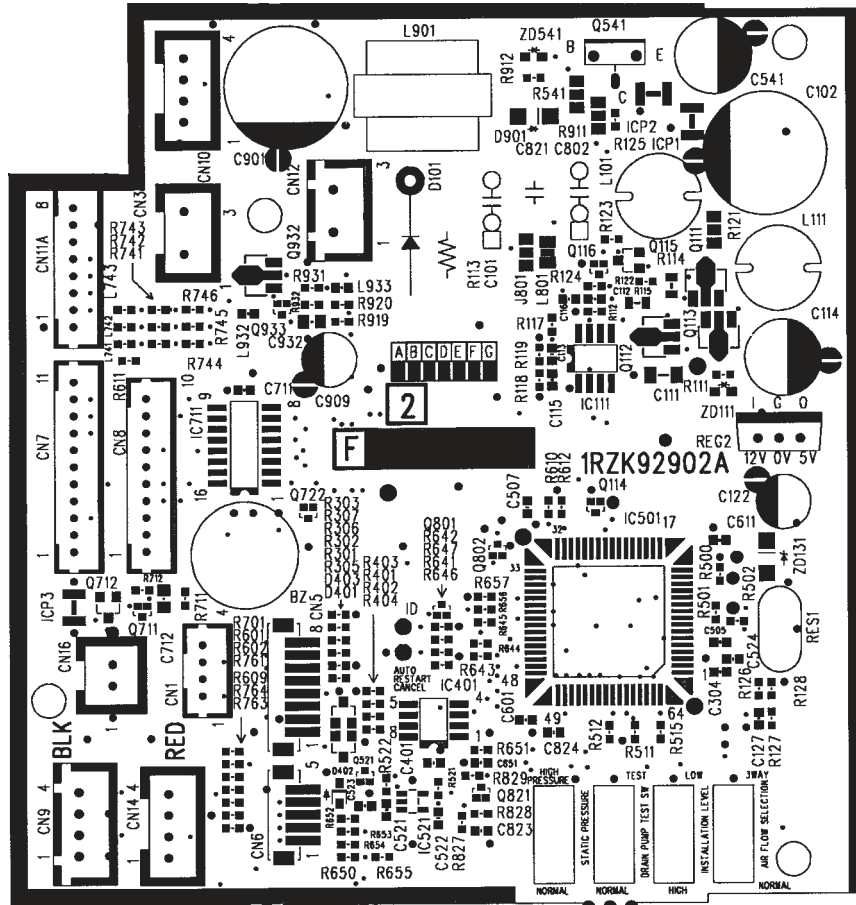

SOLDERING SIDE

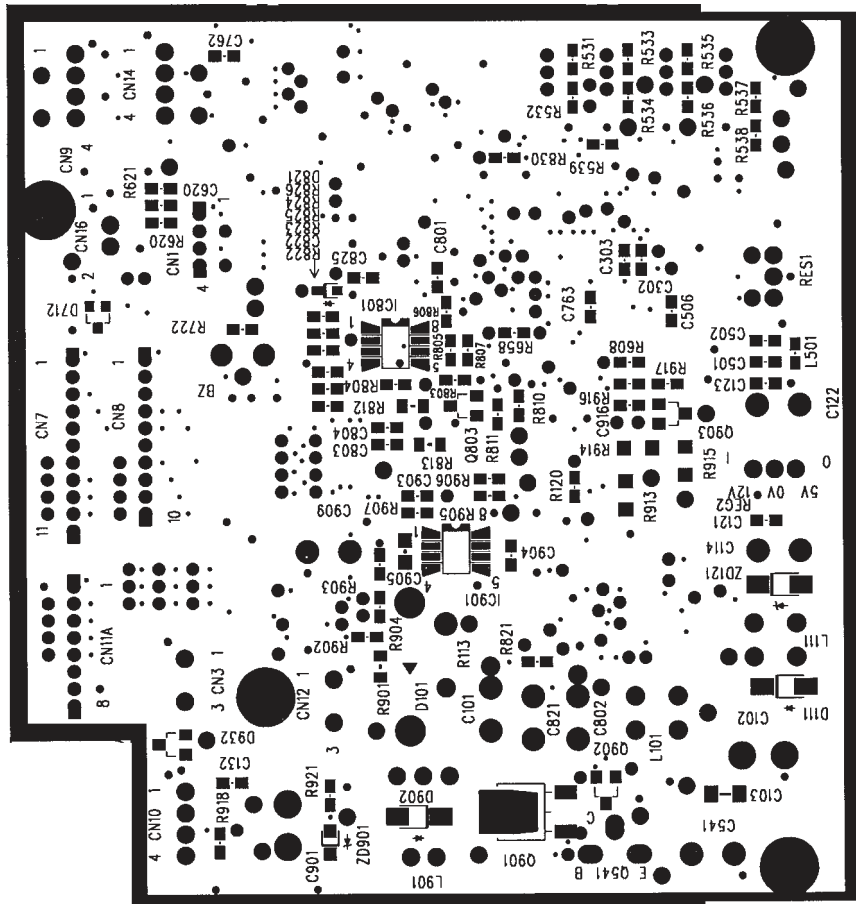

BLOCK DIAGRAM

MODEL RAI-25NH5, RAI-35NH5

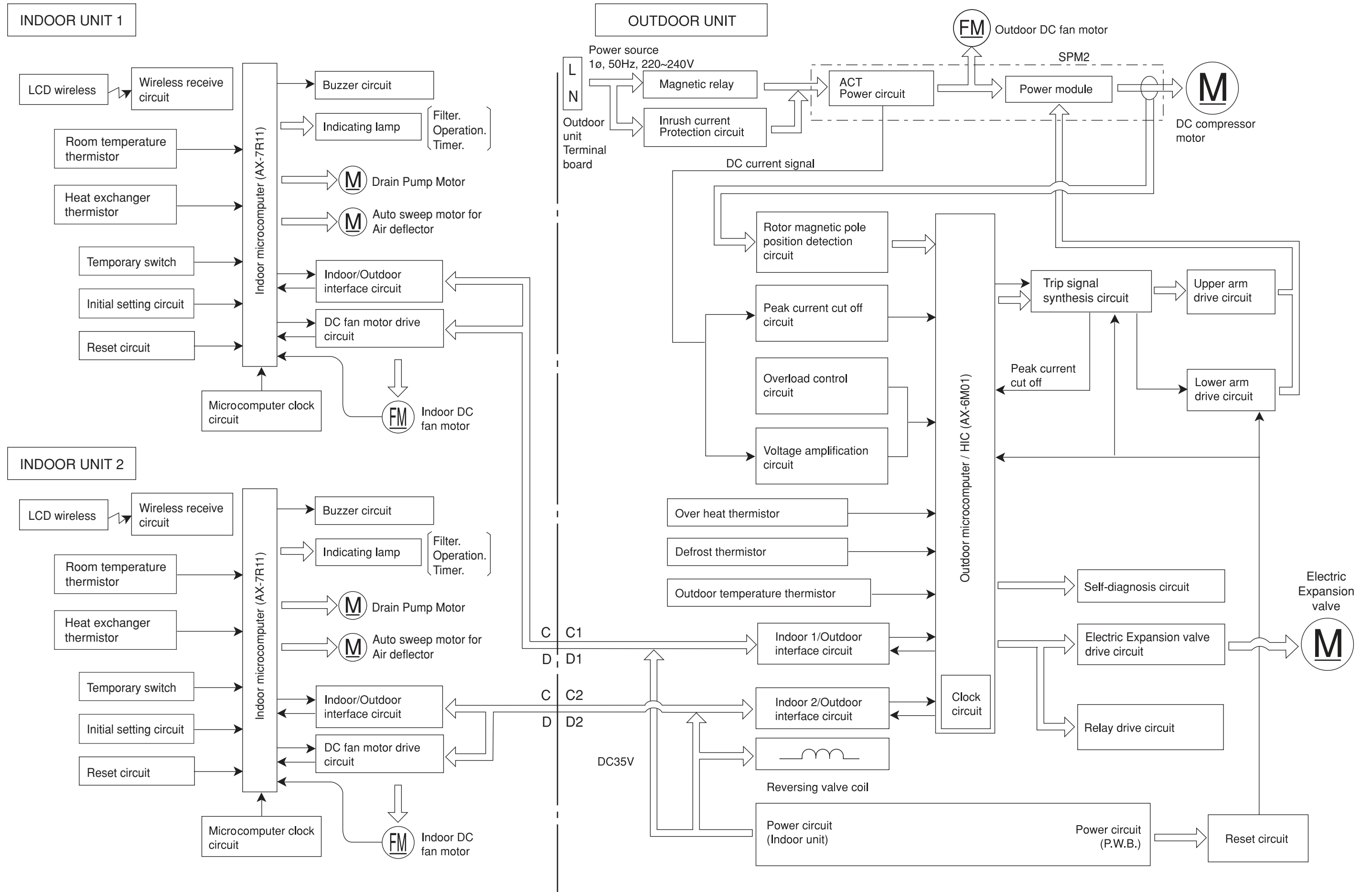

BASIC MODE

MODEL RAI-25NH5, RAI-35NH5

Operation mode	Fan	Cooling	Dehumidifying (dehumidifying operation by the function select button only, not including that engaged by the dehumidify button)	Heating	Auto										
Basic operation of start/stop switch															
Timer functions	Off-timer														
	On-timer														
	Off -> On On -> Off timer														
Fan speed mode (indoor fan)	Auto	<p>Changes from "Hi" to "Med" or "Lo" depending on room temperature.</p> <ol style="list-style-type: none"> Runs at "Hi" until first thermo off after operation is started. Runs at "Lo" when thermo is off. 	<p>Changes between "Lo" and "Med" depending on the room temperature.</p> <table border="1"> <thead> <tr> <th>Temperature division</th> <th>Fan speed</th> </tr> </thead> <tbody> <tr> <td>Division 1</td> <td>Lo</td> </tr> <tr> <td>Division 2</td> <td>Lo</td> </tr> <tr> <td>Division 3</td> <td>Med</td> </tr> <tr> <td>Division 4</td> <td>Med</td> </tr> </tbody> </table> <p>1. The indoor fan also stops when the compressor is in stop status.</p>	Temperature division	Fan speed	Division 1	Lo	Division 2	Lo	Division 3	Med	Division 4	Med	<p>Set to "ultra-Lo", "Lo", "Med", "Hi", "ultra-Hi" or "stop" depending on the room temperature, time and heat exchange temperature. Set to "stop" if the room temperature is 18°C in the "ultra-Lo" mode other than during preheating (cooling is recovered at 18.33°C).</p> <p>When the compressor is running at maximum speed during hot dash or when recovered from defrosting.</p>	<p>Operating mode is judged by room temperature and outdoor temperature.</p> <p>(1) Judging by outdoor temperature</p> <ul style="list-style-type: none"> Operating mode is judged by outdoor temperature. Only when the mode is not restricted by this judgment, the judgment by room temperature in the next paragraph will be performed. (a) Outdoor temperature $\geq 30^\circ\text{C}$: Restricted to cooling (b) Outdoor temperature $\leq 9^\circ\text{C}$: Restricted to heating <p>(2) Judging by room temperature</p> <p>Operating mode at start up is judged (initial judgment)</p> <p>(a) Conditions for judgment (any of the followings)</p> <ul style="list-style-type: none"> When auto operation is started after 1 hour has elapsed since the operation was stopped. When auto operation is started after the previous manual mode operation. When the operating mode is switched to auto while operating at manual mode. <p>(b) Judging method</p> <ul style="list-style-type: none"> Room temperature $\geq 23^\circ\text{C} \pm 3^\circ\text{C}$: Cooling Room temperature $< 23^\circ\text{C} \pm 3^\circ\text{C}$: Heating * $\pm 3^\circ\text{C}$ is the fine adjustment value from the remote controller.
	Temperature division	Fan speed													
	Division 1	Lo													
	Division 2	Lo													
Division 3	Med														
Division 4	Med														
Hi	Operates at "Hi" regardless of the room temperature.	Set to "ultra-Hi" when the compressor runs at maximum speed, and to "Hi" in other modes.	Set to "Hi" in modes other than when the compressor stops.	Set to "ultra-Lo", "Lo", "Med", "Hi", "ultra-Hi" or "stop" depending on the room temperature, and time. Set to "stop" if the room temperature is 18°C in the "ultra-Lo" mode other than during preheating (cooling is recovered at 18.33°C). Set to "ultra-Hi" when the compressor is running at maximum speed during hot dash or when recovered from defrosting.	<p>Judging operating mode change during operation (Continuous judgment)</p> <p>(a) Conditions for judgment (any of the followings)</p> <ul style="list-style-type: none"> The mode is reviewed at every interval time. When auto operation is started again before 1 hour has elapsed since the operation was stopped. <p>(b) Judging method</p> <ul style="list-style-type: none"> Judge by setting the hysteresis on the final preset temperature. The final preset temperature is the actually targeted preset temperature which is the sum of the basic preset temperature and each type of shift value (e.g. $\pm 3^\circ\text{C}$ by remote controller, preset temperature correction value, powerful shift value, etc.). [Currently cooling] <ul style="list-style-type: none"> Room temperature \leq Final preset temperature -3°C Change to heating Room temperature $>$ Final preset temperature -3°C Continue cooling [Currently heating] <ul style="list-style-type: none"> Room temperature \geq Final preset temperature $+2^\circ\text{C}$ Change to cooling Room temperature $<$ Final preset temperature $+2^\circ\text{C}$ Continue heating 										
Med	Operates at "Med" regardless of the room temperature.	Same as at left.	Set to "Med" in modes other than when the compressor stops.	Set to "ultra-Lo", "Lo", "Med" or "stop" depending on the room temperature and time. Set to "stop" if the room temperature is 18°C in the "ultra-Lo" mode other than during preheating (cooling is recovered at 18.33°C).											
Lo	Operates at "Lo" regardless of the room temperature.	Same as at left.	Set to "Lo" in modes other than when the compressor stops.	Set to "ultra-Lo", "Lo", or "stop" depending on the room temperature and time. Set to "stop" if the room temperature is 18°C in the "ultra-Lo" mode other than during preheating (cooling is recovered at 18.33°C). The fan speed is controlled by the heat exchanger temperature; the overload control is executed as in the following diagram:											
Basic operation of temperature controller	<p>Performs only fan operation at the set speed regardless of the room temperature.</p>	See page 47.	See page 51.	See page 53.											
Sleep operation (with sleep button ON)	<ul style="list-style-type: none"> Enters sleep operation after set as on the left. Action during sleep operation Lo (sleep) operation 	<ul style="list-style-type: none"> Same as at left See page 49. 	<ul style="list-style-type: none"> Same as at left See page 51. 	<ul style="list-style-type: none"> Same as at left See page 55. 	<ul style="list-style-type: none"> Same as at left. Performs the sleep operation of each operation mode. 										

Table 1 Mode data file

	RAI-25NH5	RAI-35NH5
LABEL NAME	VALUE	
WMAX	4400 min ⁻¹	6000 min ⁻¹
WMAX2	4500 min ⁻¹	6000 min ⁻¹
WSTD	3300 min ⁻¹	4250 min ⁻¹
WBEMAX	2800 min ⁻¹	3500 min ⁻¹
CMAX	2900 min ⁻¹	4700 min ⁻¹
CMAX2	3000 min ⁻¹	4700 min ⁻¹
CSTD	2350 min ⁻¹	4100 min ⁻¹
CKYMAX	2200 min ⁻¹	3500 min ⁻¹
CJKMAX	1800 min ⁻¹	2700 min ⁻¹
CBEMAX	1600 min ⁻¹	2000 min ⁻¹
WMIN	1500 min ⁻¹	1800 min ⁻¹
CMIN	1500 min ⁻¹	1800 min ⁻¹
STARTMC	60 Seconds	60 Seconds
DWNRATEW	80%	80%
DWNRATEC	80%	80%
SHIFTW	4.00°C	4.00°C
SHIFTC	-1.00°C	-2.99°C
CLMXTP	30.00°C	30.00°C
YNEOF	21.00°C	21.00°C
TEION	2.00°C	2.00°C
TEIOF	6.00°C	6.00°C
SFTDSW	2.66°C	2.66°C
DFTIM1	50 Minutes	50 Minutes
DFTIM2	90 Minutes	90 Minutes
DFTIM3	60 Minutes	60 Minutes

Basic Cooling Operation

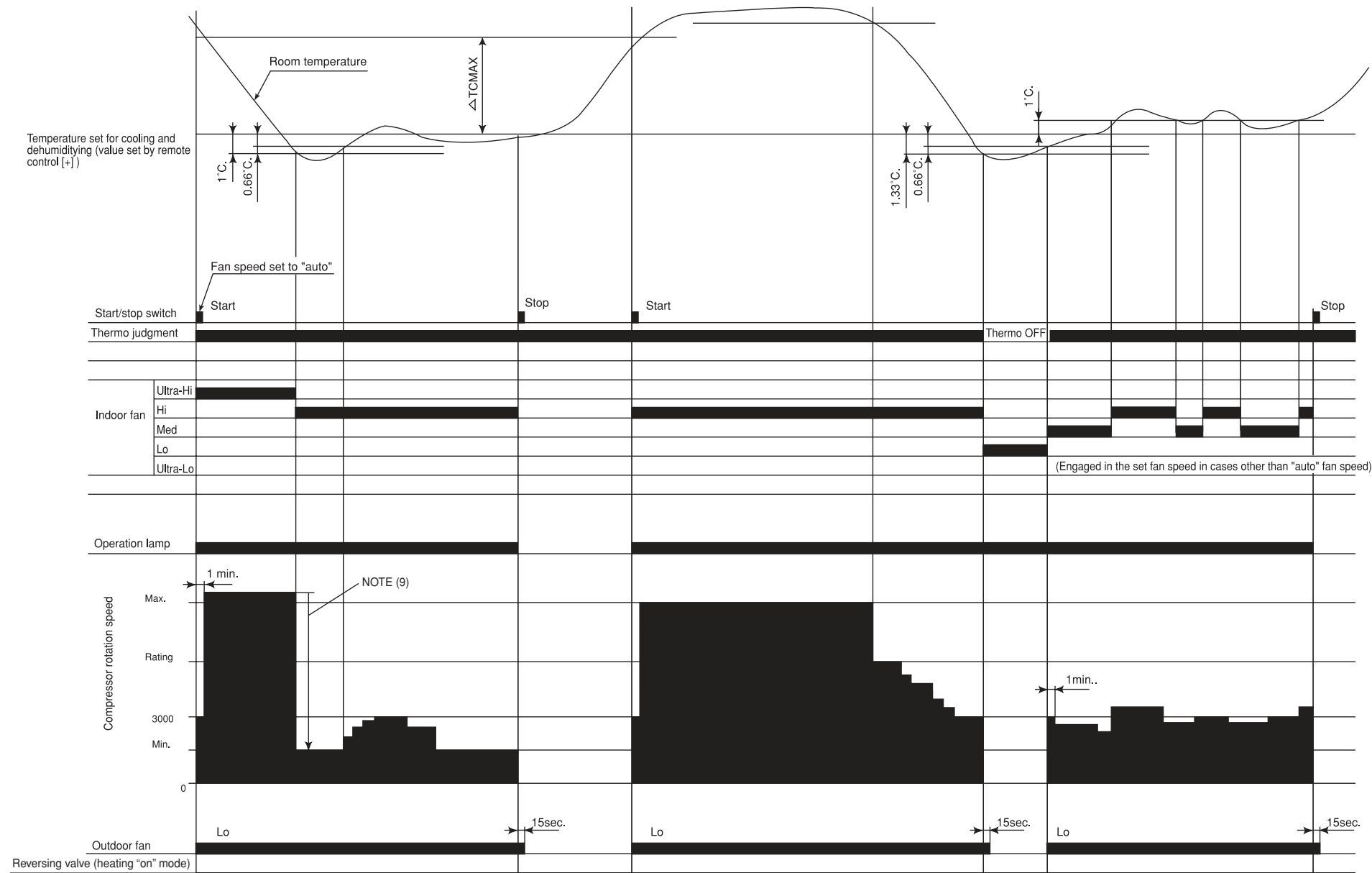

Table 2 ΔTC_{MAX}

Temperature difference	Calculated compressor rpm
1.66	2265 min ⁻¹
2	2435 min ⁻¹
2.33	2600 min ⁻¹
2.66	2765 min ⁻¹
3	2935 min ⁻¹
3.33	3100 min ⁻¹
3.66	3265 min ⁻¹
4	3435 min ⁻¹
4.33	3600 min ⁻¹
4.66	3765 min ⁻¹
5	3935 min ⁻¹
5.33	4100 min ⁻¹
5.66	4265 min ⁻¹
6	4435 min ⁻¹
6.33	4600 min ⁻¹
6.66	4765 min ⁻¹
7	4935 min ⁻¹
7.33	5100 min ⁻¹
7.66	5265 min ⁻¹
8	5435 min ⁻¹
8.33	5600 min ⁻¹
8.66	5765 min ⁻¹
9	5935 min ⁻¹
9.33	6100 min ⁻¹
9.66	6265 min ⁻¹
10	6435 min ⁻¹
10.33	6600 min ⁻¹
10.66	6765 min ⁻¹
11	6935 min ⁻¹

Note:

- See the data in Table 1 on page 45 for each constant in capital letters in the diagrams.

Notes:

- Condition for entering into Cool Dashed mode. When fan set to "Hi" or "Auto mode" and temperature difference between indoor temperature and set temperature has a corresponding compressor rpm larger than WMAX.
- Cool Dashed will release when i) a maximum 25 minutes is lapsed and ii) room temperature is lower than set temperature -3°C (thermo off) and iii) when room temperature has achieved setting temperature -1°C then maximum Cool Dashed time will be revised to 20 minutes. And iv) indoor fan is set to Lo and Med fan mode and v) change operation mode.
- During Cool Dashed operation, thermo off temperature is set temperature (with shift value) -3°C . After thermo off, operation continue in Fuzzy control mode.
- Compressor minimum "ON" time and "OFF" time is 3 minutes.
- During normal cooling mode, compressor maximum rpm CMAX will maintain for 60 minutes if indoor temperature is lower than CLMXTP. No time constrain if indoor temperature is higher than CLMXTP.
- When fan is set to "Hi", compressor rpm will be limited to CKYMAX.
- When fan is set to "Med", compressor rpm will be limited to CJKMAX.
- When fan is set to "Lo", compressor rpm will be limited to CBEMAX.
- During Cool Dashed, when room temperature reaches set temperature -1°C compressor rpm is actual rpm x DWNRATEC.

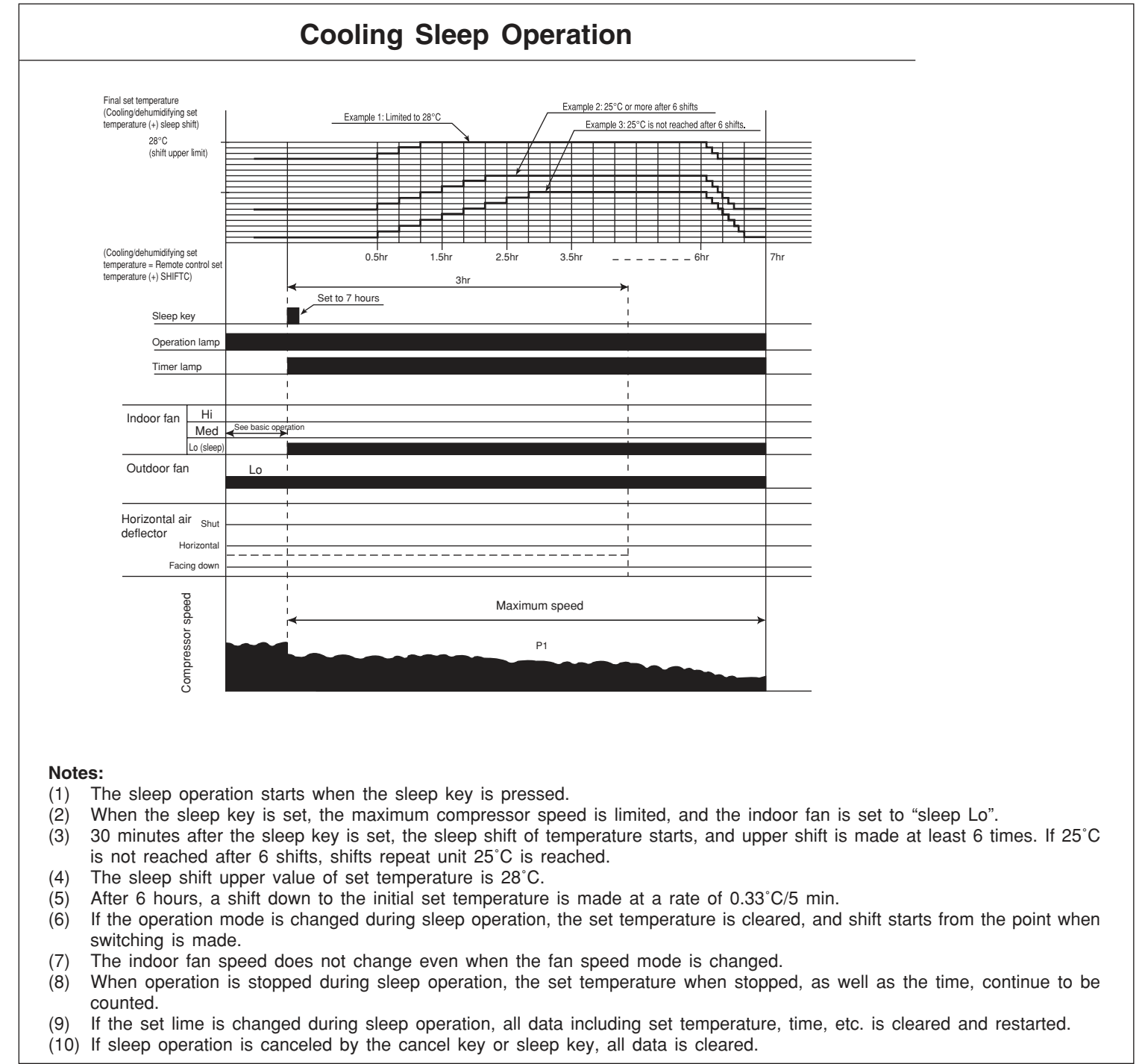
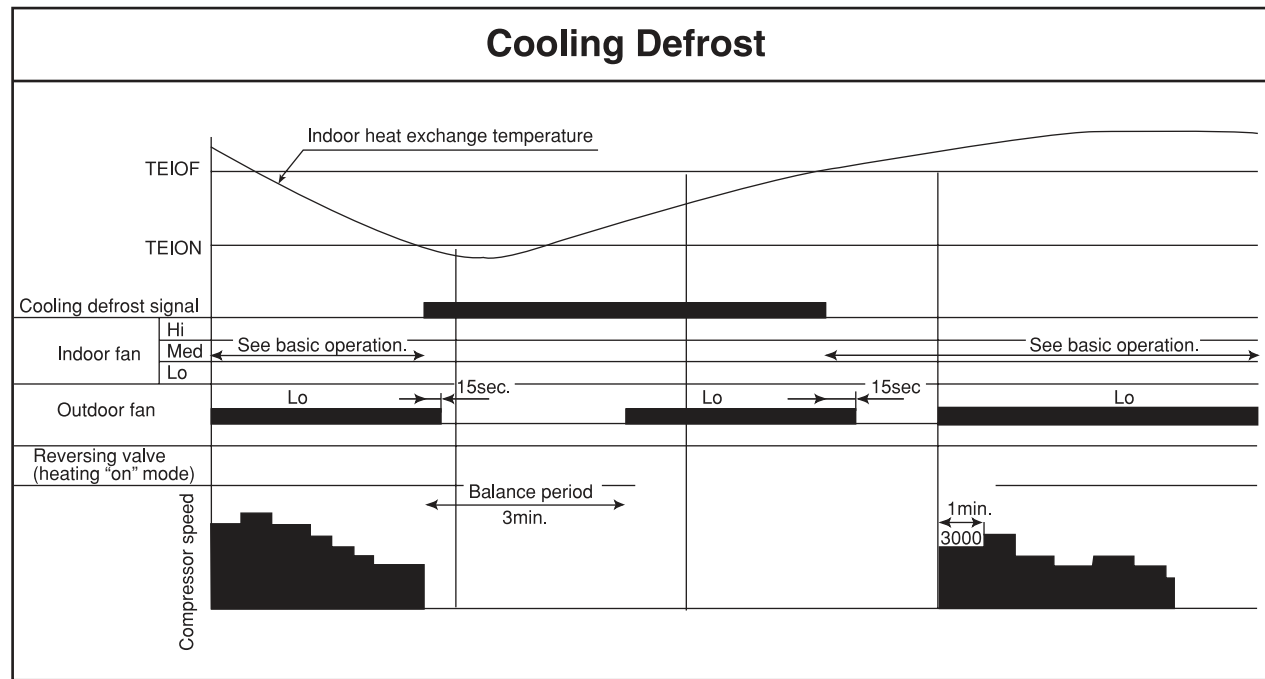

Notes:

- (1) The sleep operation starts when the sleep key is pressed.
- (2) When the sleep key is set, the maximum compressor speed is limited, and the indoor fan is set to "sleep Lo".
- (3) 30 minutes after the sleep key is set, the sleep shift of temperature starts, and upper shift is made at least 6 times. If 25°C is not reached after 6 shifts, shifts repeat until 25°C is reached.
- (4) The sleep shift upper value of set temperature is 28°C.
- (5) After 6 hours, a shift down to the initial set temperature is made at a rate of 0.33°C/5 min.
- (6) If the operation mode is changed during sleep operation, the set temperature is cleared, and shift starts from the point when switching is made.
- (7) The indoor fan speed does not change even when the fan speed mode is changed.
- (8) When operation is stopped during sleep operation, the set temperature when stopped, as well as the time, continue to be counted.
- (9) If the set time is changed during sleep operation, all data including set temperature, time, etc. is cleared and restarted.
- (10) If sleep operation is canceled by the cancel key or sleep key, all data is cleared.

Dehumidifying

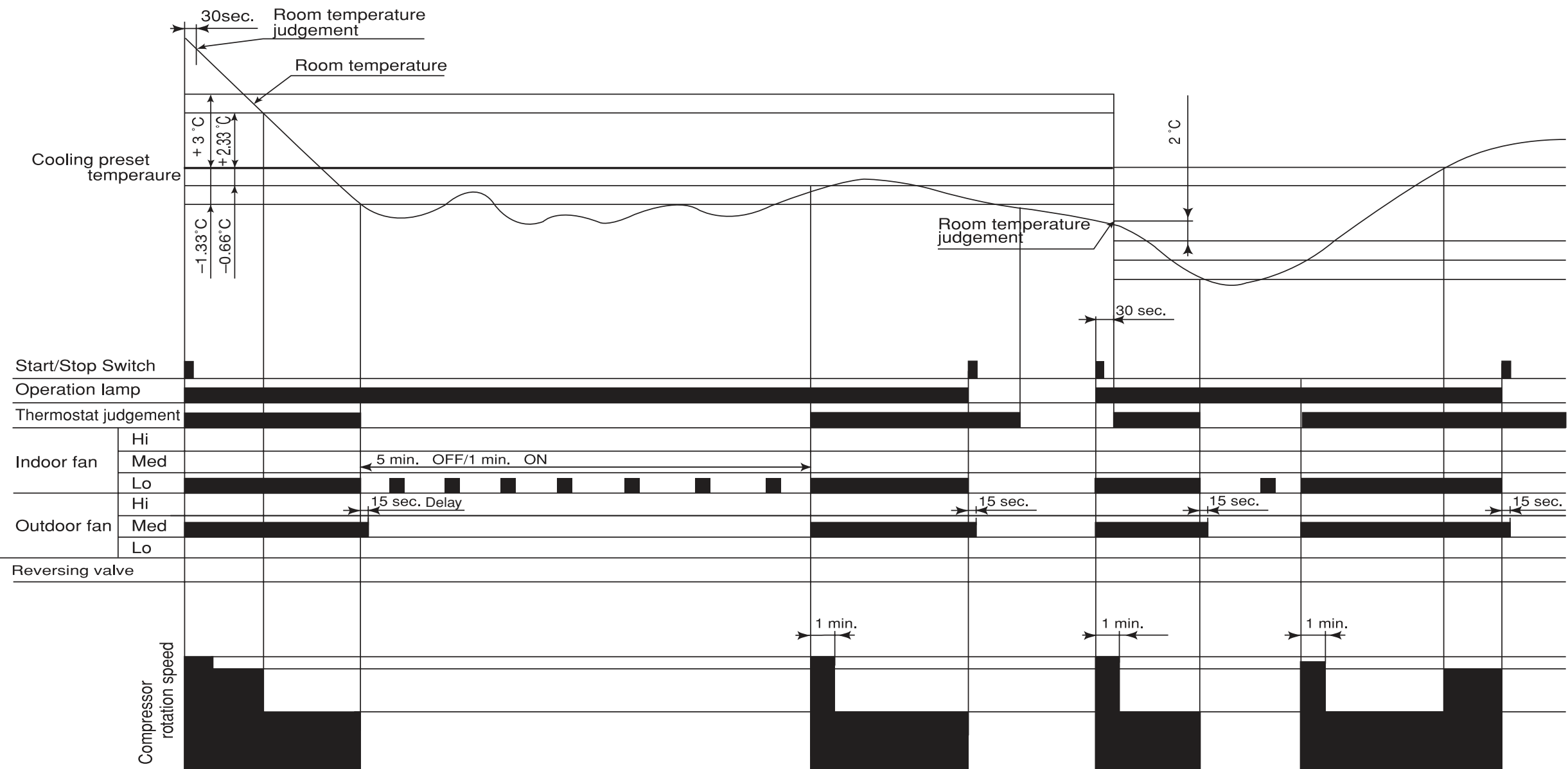

Notes:

- (1) If the room temperature is (cooling preset temperature) - (1.33°C) or less after 30 seconds from starting the operation, the operation is done assuming as the preset temperature = (room temperature at the time) - (2°C).
- (2) The indoor fan is operated in the "Lo" mode. During thermo OFF indoor fan will be OFF for 5 minutes and ON for 1 minute.
- (3) When the operation is started by the thermostat turning ON, the start of the indoor fan is delayed 32 seconds after the start of compressor operation.
- (4) The compressor is operated forcedly for 3 minutes after operation is started.
- (5) The minimum ON time and OFF time of the compressor are 3 minutes.

Basic Heating Operation

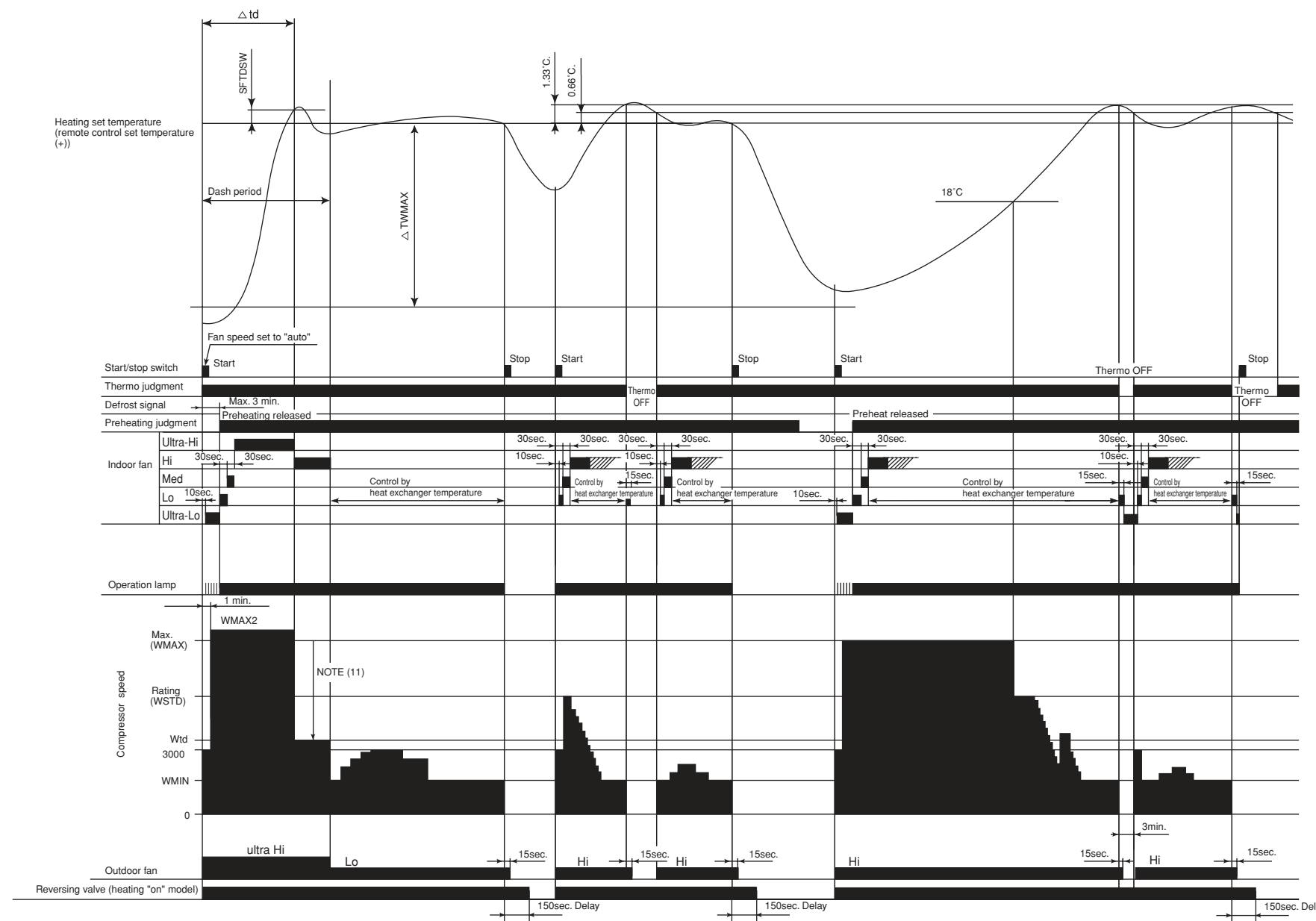

Table 3 $\Delta TWMAX$

Temperature difference	Calculated compressor rpm
1.66	1965 min ⁻¹
2	2135 min ⁻¹
2.33	2300 min ⁻¹
2.66	2465 min ⁻¹
3	2635 min ⁻¹
3.33	2800 min ⁻¹
3.66	2965 min ⁻¹
4	3135 min ⁻¹
4.33	3300 min ⁻¹
4.66	3465 min ⁻¹
5	3635 min ⁻¹
5.33	3800 min ⁻¹
5.66	3965 min ⁻¹
6	4135 min ⁻¹
6.33	4300 min ⁻¹
6.66	4465 min ⁻¹
7	4635 min ⁻¹
7.33	4800 min ⁻¹
7.66	4965 min ⁻¹
8	5135 min ⁻¹
8.33	5300 min ⁻¹
8.66	5465 min ⁻¹
9	5635 min ⁻¹
9.33	5800 min ⁻¹
9.66	5965 min ⁻¹
10	6135 min ⁻¹
10.33	6300 min ⁻¹
10.66	6465 min ⁻¹
11	6635 min ⁻¹

Notes:

- (1) Condition for entering into Hot Dashed mode. When fan set to "Hi" or "Auto mode" and i) Indoor temperature is lower than 18°C , and ii) outdoor temperature is lower than 10°C , and iii) Temperature difference between indoor temperature and set temperature has a corresponding compressor rpm larger than WMAX.
- (2) Hot Dashed will release when i) Room temperature has achieved the set temperature + SFTDSW. ii) Thermo off.
- (3) During Hot Dashed operation, thermo off temperature is set temperature (with shift value) $+3^\circ\text{C}$. After thermo off, operation continue in Fuzzy control mode.
- (4) Compressor minimum "ON" time and "OFF" time is 3 minutes.
- (5) During normal heating mode, compressor maximum rpm WMAX will maintain for 120 minutes if indoor temperature is higher than 18°C . No time limit constrain if indoor temperature is lower than 18°C and outdoor temperature is lower than 2°C .
- (6) During Hotkeep or Defrost mode, indoor operation lamp will blink at interval of 3 seconds "ON" and 0.5 second "OFF".
- (7) When heating mode starts, it will enter into Hotkeep mode if indoor heat exchanger temperature is lower than YNEOF + 0.33°C .
- (8) When fan is set to "Med" or "Lo", compressor rpm will be limited to WBEMAX.
- (9) In "Ultra-Lo" fan mode, if indoor temperature is lower than 18°C , indoor fan will stop. If indoor temperature is higher than $18^\circ\text{C} + 0.33^\circ\text{C}$, fan will continue in "Ultra-Lo" mode. During Hotkeep or Defrost mode, fan will continue in "Ultra-Lo" mode.
- (10) During Hot Dashed or outdoor temperature is lower than -5°C , compressor rpm is WMAX2.
- (11) During Hot Dashed, when room temperature reaches set temperature + SFTDSW compressor rpm is actual rpm x DWNRATEW.

Notes:

1. See the data in Table 1 on page 45 for each constant in capital letters in the diagrams.

Reversing Valve Defrosting

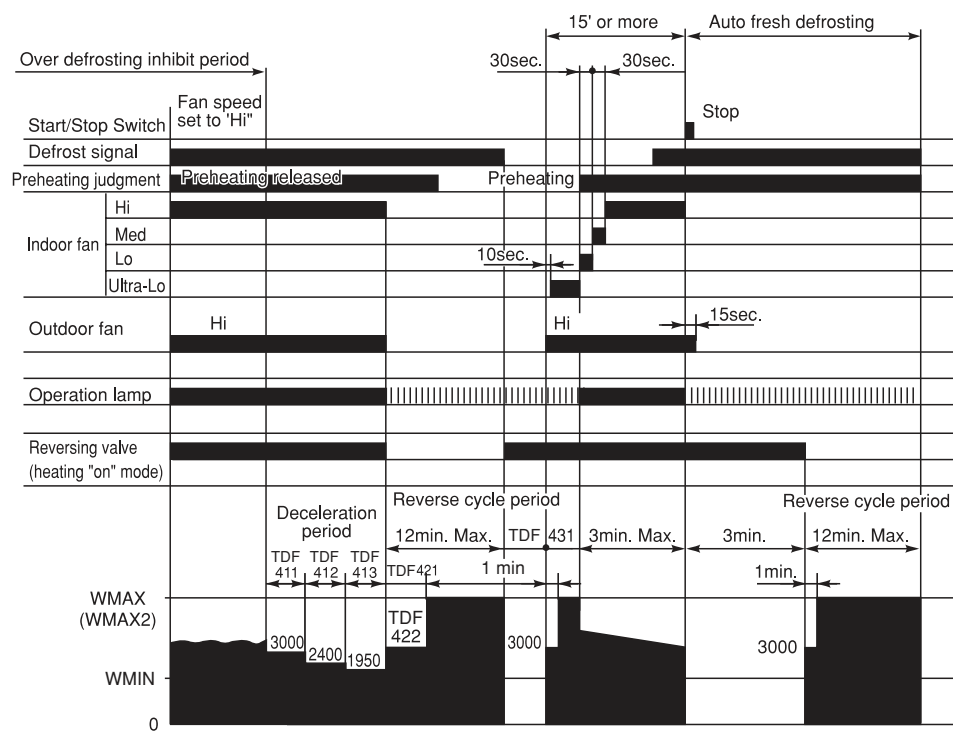

Notes:

- (1) The defrosting inhibit period is set as shown in the diagram below. When defrosting has finished once, the inhibit period is newly set, based on the outdoor temperature when the compressor was started. During this period, the defrost signal is not accepted.
- (2) If the difference between the room and outdoor temperature is large when defrosting is finished, the maximum compressor speed (WMAX) or (WMAX2) can be continued for 120 minutes maximum.
- (3) The defrosting period is 12 minutes maximum.
- (4) When operation is stopped during defrosting, it is switched to auto refresh defrosting.
- (5) Auto refresh defrosting cannot be engaged within 15 minutes after operation is started or defrosting is finished.

Setting Defrosting Inhibit Period

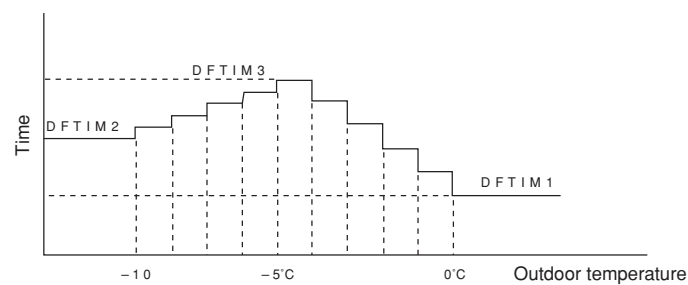

Notes:

- (1) The first inhibit time after operation start is set to DFTIM1.
- (2) From the second time onwards, the inhibit time is set according to the time required for defrosting.
Reverse cycle operation time \geq [DEFCOL] : DFTIM1 is set.
Reverse cycle operation time $<$ [DEFCOL] : The time corresponding to outdoor temperature is set.

Heating Sleep Operation

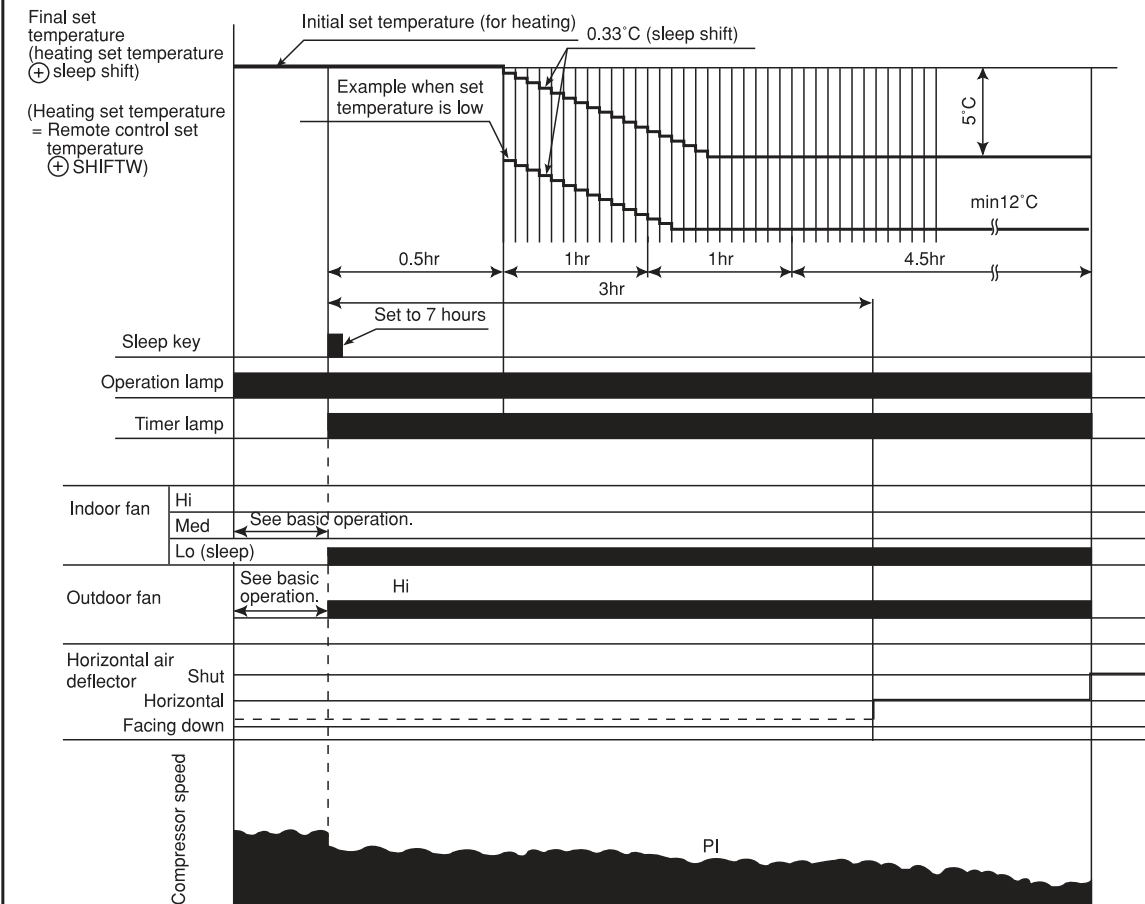

Notes:

- (1) The sleep operation starts when the sleep key is pressed.
- (2) When the sleep key is set, the maximum compressor speed is limited to WSTD+2000/2, and the indoor fan is set to "sleep Lo".
- (3) 30 minutes after the sleep key is set, the sleep shift of set temperature starts.
- (4) The maximum sleep shift of set temperature is 5°C, and the minimum is 12°C.
- (5) If the operation mode is changed during sleep operation, the changed operation mode is set and sleep control starts.
- (6) The indoor fan speed does not change even when the fan speed mode is changed. (Lo)
- (7) When defrosting is to be set during sleep operation, defrosting is engaged and sleep operation is restored after defrosting.
- (8) When operation is stopped during sleep operation, the set temperature when stopped, as well as the time, continue to be counted.
- (9) If the set time is changed during sleep operation, all data including set temperature, time, etc. is cleared and restarted.
- (10) If sleep operation is canceled by the cancel key or sleep key, all data is cleared.

REFRIGERATING CYCLE DIAGRAM RAI-25NH5 / RAI-35NH5

Cooling, dehumidifying, defrosting

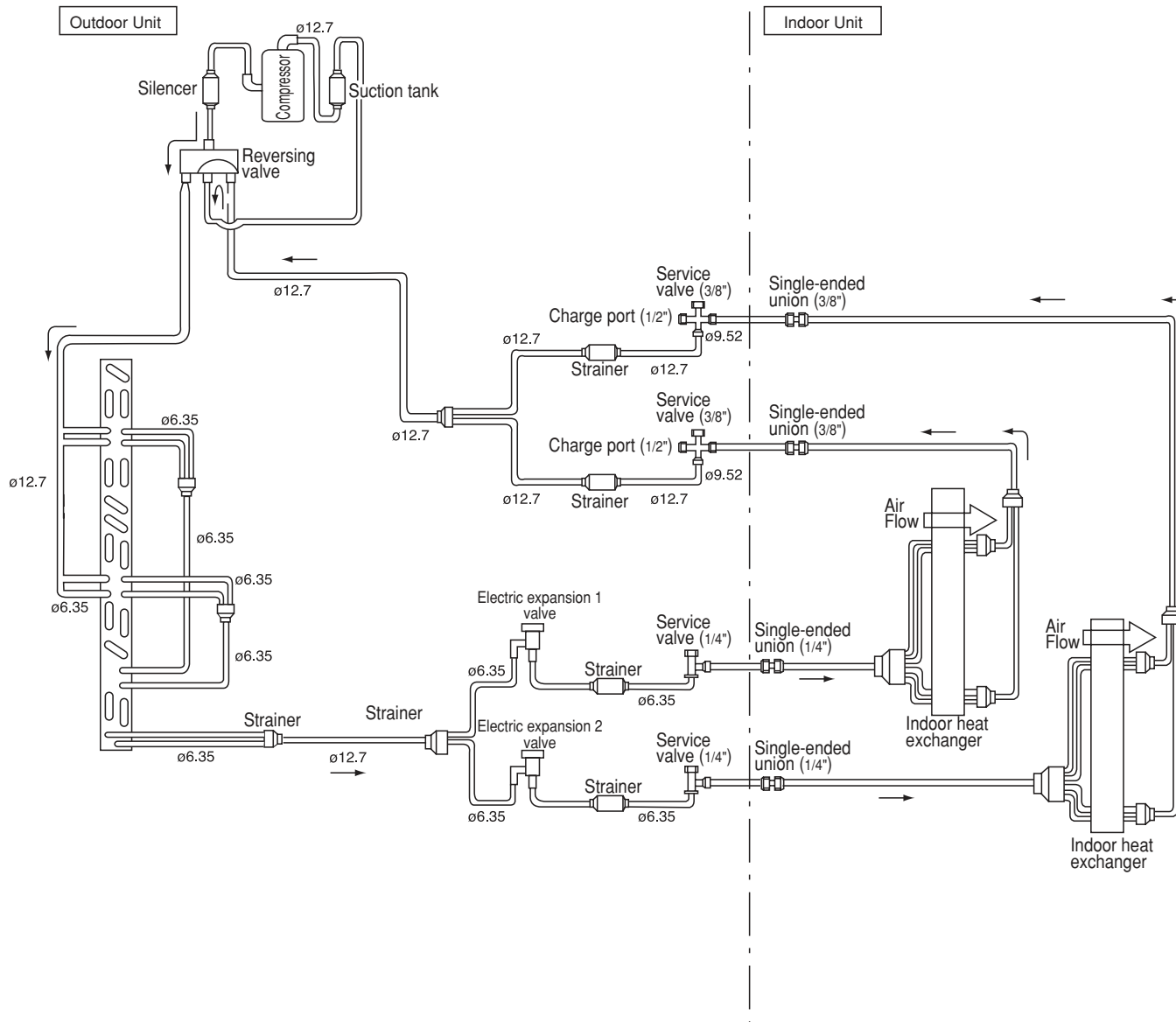

REFRIGERATING CYCLE DIAGRAM RAI-25NH5 / RAI-35NH5

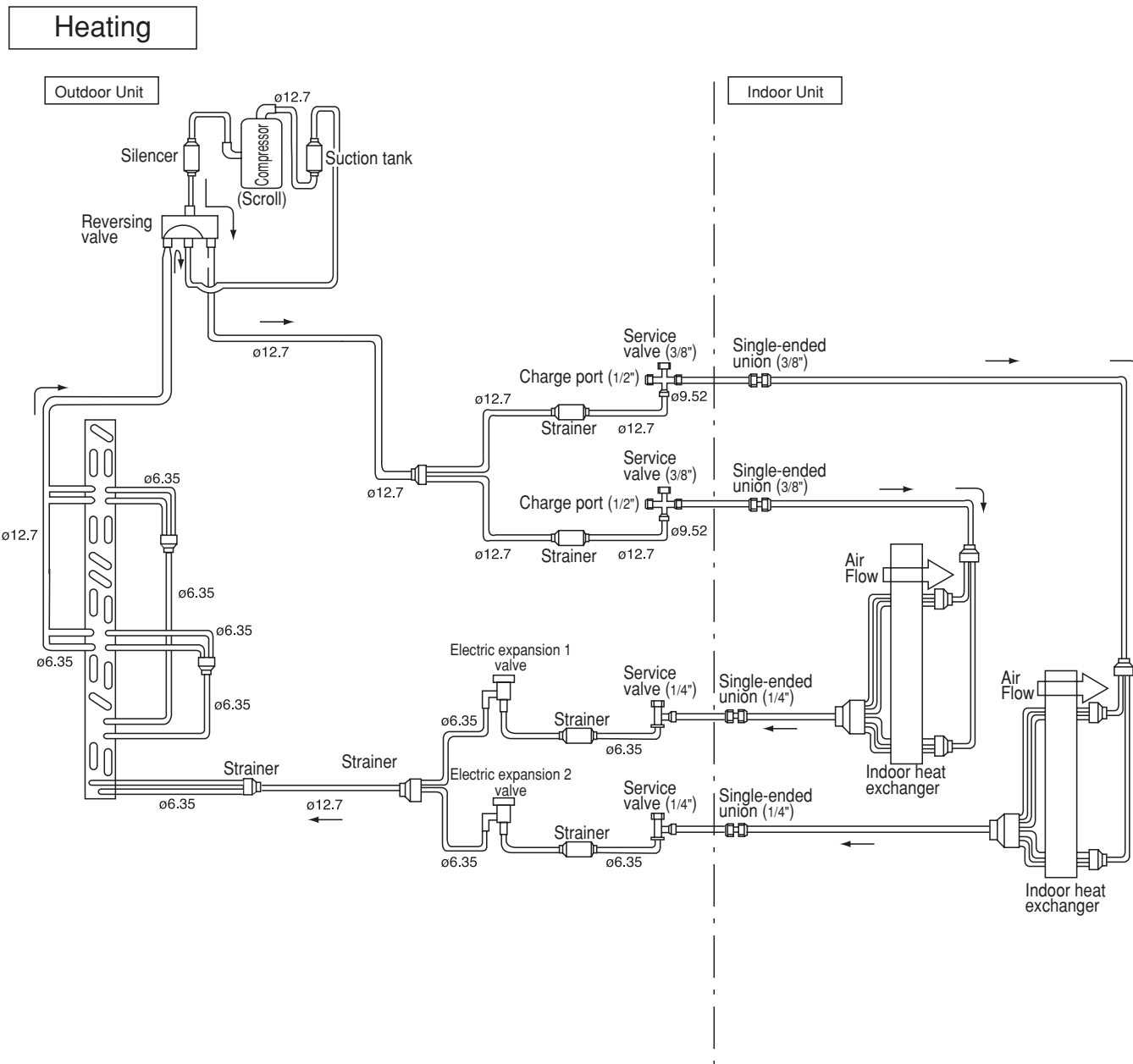

AUTO SWING FUNCTION

MODEL: RAI-25NH5, RAI-35NH5

INPUT SIGNAL	PRESENT CONDITION			OPERATING SPECIFICATION	REFERENCE
	OPERATION	OPERATION MODE	AIR DEFLECTOR		
KEY INPUT	STOP	EACH MODE	STOP	ONE SWING (CLOSING AIR DEFLECTOR) ① DOWNWARD ② UPWARD	INITIALIZE AT NEXT OPERATION.
			DURING ONE SWING	STOP AT THE MOMENT.	
	DURING OPERATION	AUTO COOL COOL FAN AUTO DRY DRY	STOP	START SWINGING ① DOWNWARD ② UPWARD ③ DOWNWARD	
			DURING SWINGING	STOP AT THE MOMENT.	
		AUTO HEAT HEAT CIRCULATOR	STOP	START SWINGING ① DOWNWARD ② UPWARD ③ DOWNWARD	
			DURING SWINGING	STOP AT THE MOMENT.	
THERMO. ON (INTERNAL FAN ON)	DURING OPERATION	AUTO DRY DRY AUTO HAET HEAT CIRCULATOR	TEMPORARY STOP	START SWING AGAIN.	
THERMO. ON (INTERNAL FAN OFF)			DURING SWINGING	STOP SWINGING TEMPORARILY. (SWING MODE IS CLEARED IF SWING COMMAND IS TRANSMITTED DURING TEMPORARY STOP.)	
MAIN SWITCH ON	STOP	COOL FAN DRY	STOP DURING ONE SWING	INITIALIZE ① DOWNWARD ② UPWARD	
		HEAT CIRCULATOR	STOP DURING ONE SWING	INITIALIZE ① DOWNWARD	
MAIN SWITCH OFF	DURING OPERATION	EACH MODE	STOP DURING SWINGING	ONE SWING (CLOSING AIR DEFLECTOR) ① DOWNWARD ② UPWARD	INITIALIZE AT NEXT OPERATION.
			DURING INITIALIZING		
CHANGE OF OPERATION	DURING OPERATION	EACH MODE	STOP	INITIALIZING CONDITION OF EACH MODE.	
			DURING SWINGING	STOP SWINGING AND MODE BECOMES INITIALIZING CONDITION.	

DESCRIPTION OF MAIN CIRCUIT OPERATION

MODEL RAI-25NH5, RAI-35NH5

1. Reset Circuit

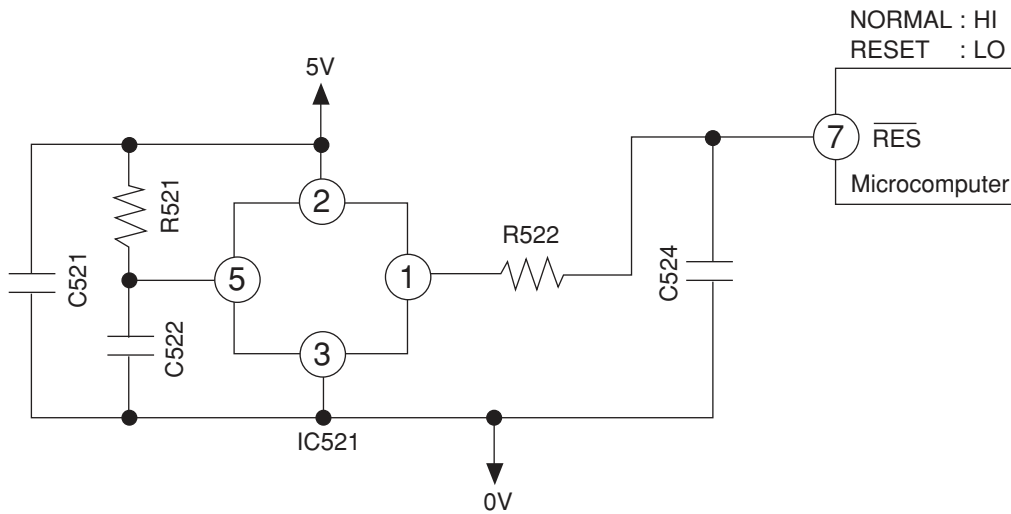

Fig. 1-1

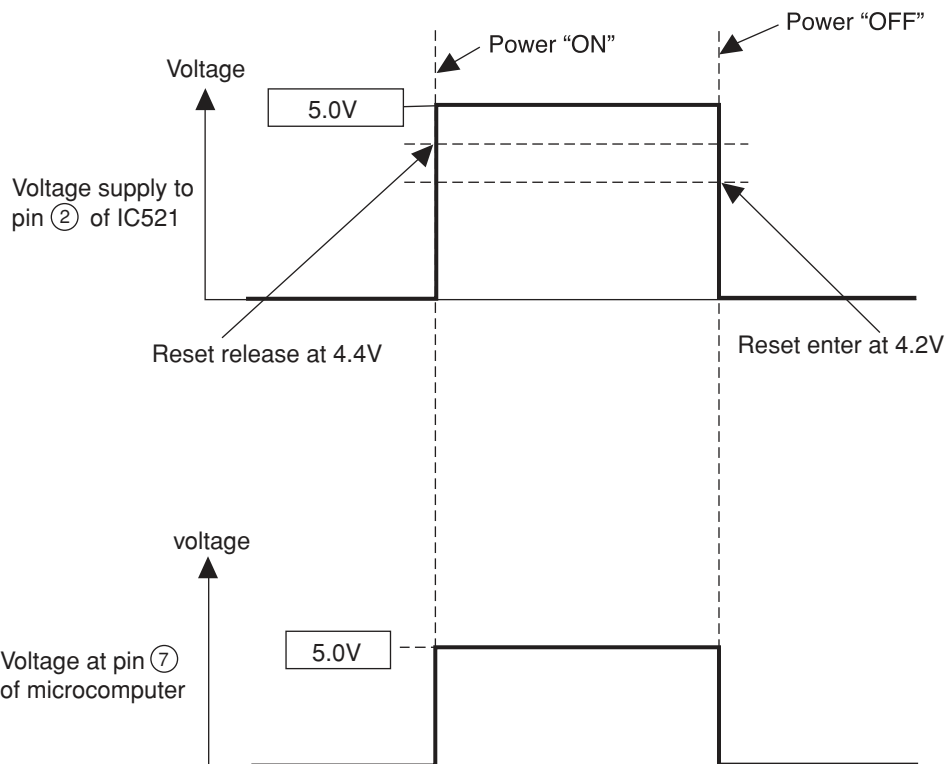

Fig. 1-2

- The reset circuit initializes the microcomputer program when power is ON or OFF.
- Low voltage at pin 7 resets the microcomputer and Hi activates the microcomputer.
- When power "ON" 5V voltage rises and reaches 4.4V, pin 1 of IC521 is set to "Hi". At this time the microcomputer starts operation.
- When power "OFF" voltage drops and reaches 4.2V, pin 1 of IC521 is set to "Low". This will RESET the microcomputer.

2. Receiver Circuit

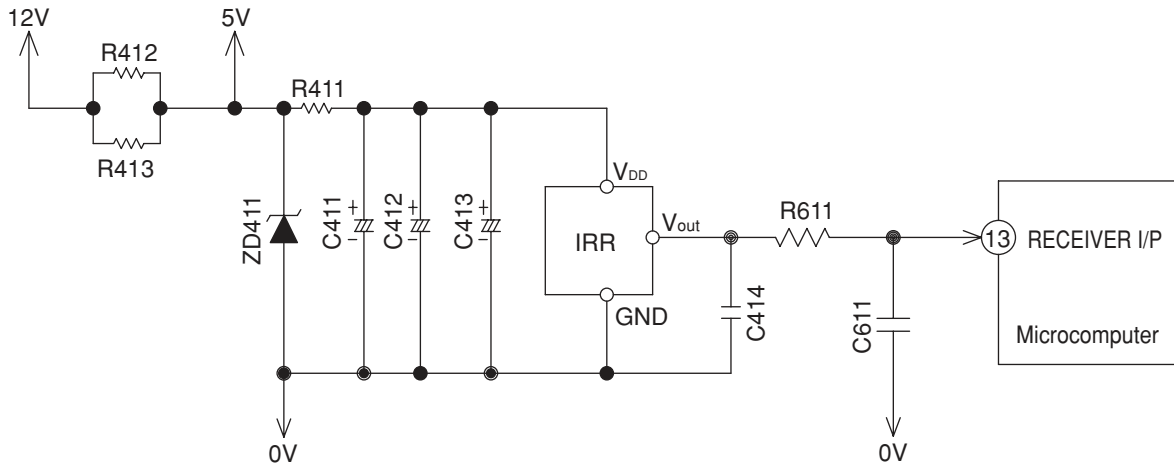

Fig. 2-1

- The light receiver unit receives the infrared signal from the wireless remote control. The receiver amplifies and shapes the signal and outputs it.

3. Buzzer Circuit

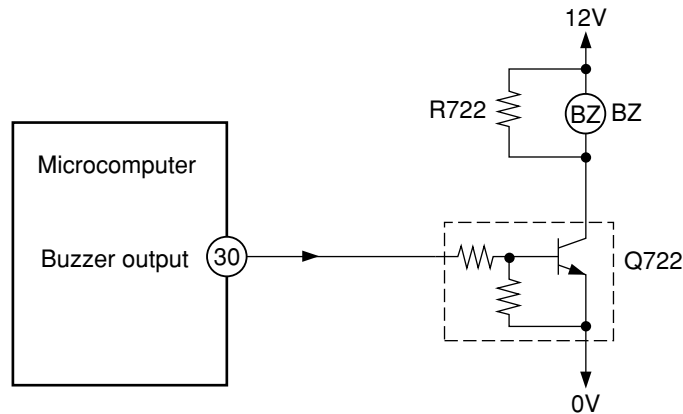

Fig. 3-1 Buzzer Circuit

- When the buzzer sounds, an approx. 3.9kHz square signal is output from buzzer output pin (30) of the microcomputer. After the amplitude of this signal has been set to 12Vp-p by a transistor, it is applied to the buzzer. The piezoelectric element in the buzzer oscillates to generate the buzzer's sound.

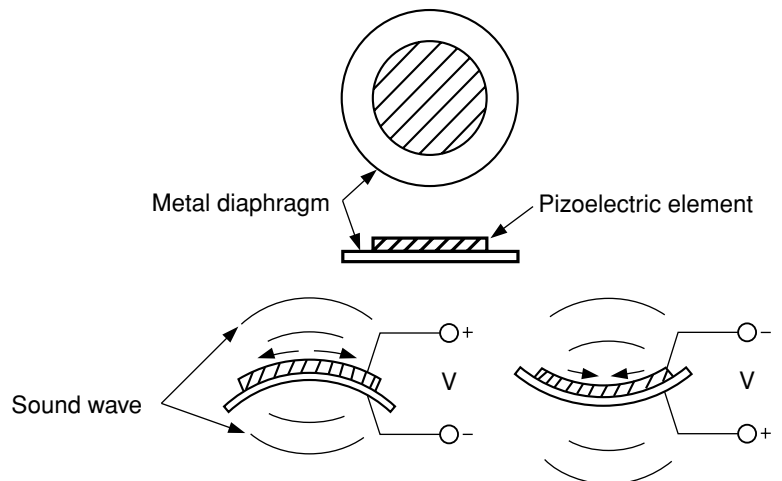

Fig. 3-2 Buzzer Operation

4. Auto Sweep Motor Circuit

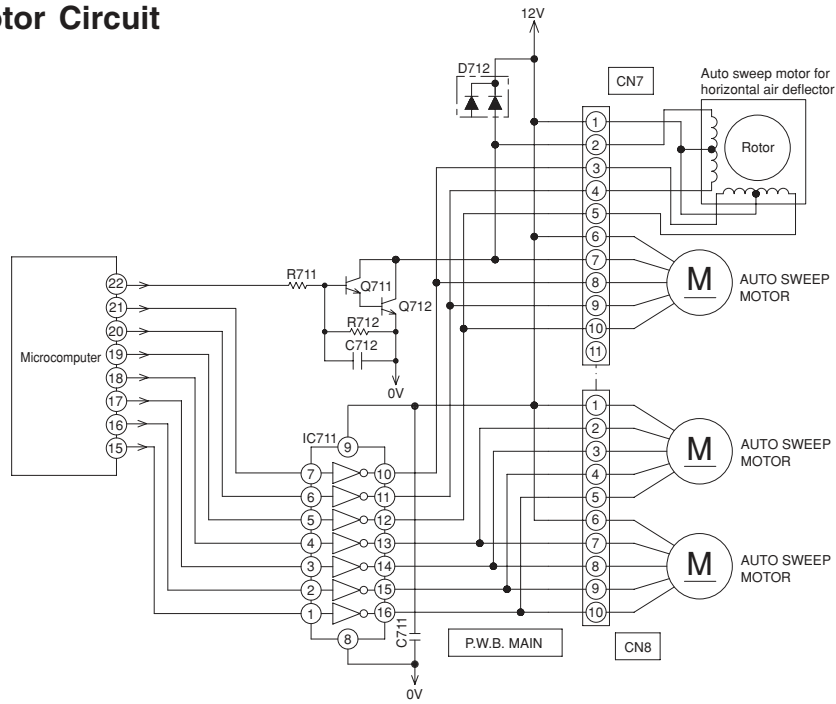

Fig.4-1

- Fig. 4-1 shows the Auto sweep motor drive circuit; the signals shown in Fig.4-2 are output from pins ⑮ – ㉒ of microcomputer.

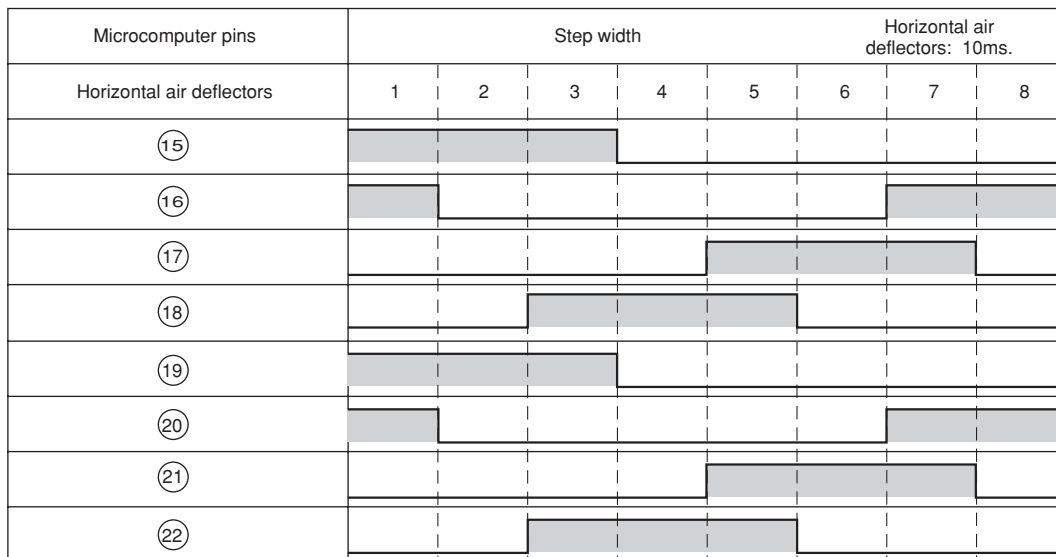

Fig.4-2 Microcomputer Output Signals

- As the microcomputer's outputs change as shown in Fig.4-2, the core of the auto sweep motor is excited to turn the rotor. Table 4-1 shows the rotation angle of horizontal air deflectors.

Table 4-1 Auto sweep Motor Rotation

	Rotation angle per step (°)	Time per step (ms.)
Horizontal air deflectors	0.0882	10

- The air deflectors are driven by the stepping motors, which are instructed by the microcomputer.
- The air deflectors on the left and right are each driven by two stepping motors.
- The stepping motors and main unit are connected via relay connectors. The air deflectors will not operate unless the relay connectors are connected: Securely connect the relay connectors identified by colors when attaching the panel.
- Before removing the panel for servicing, be sure to disconnect the relay connector to protect the lead wires.

5. Room Temperature Thermistor Circuit

- Fig. 5-1 shows the room temperature thermistor circuit.

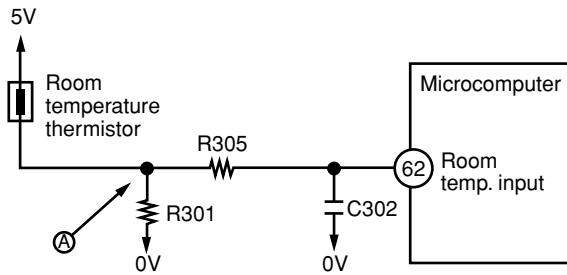

Fig. 5-1

- The voltage at (A) depends on the room temperature as shown in Fig. 5-2.

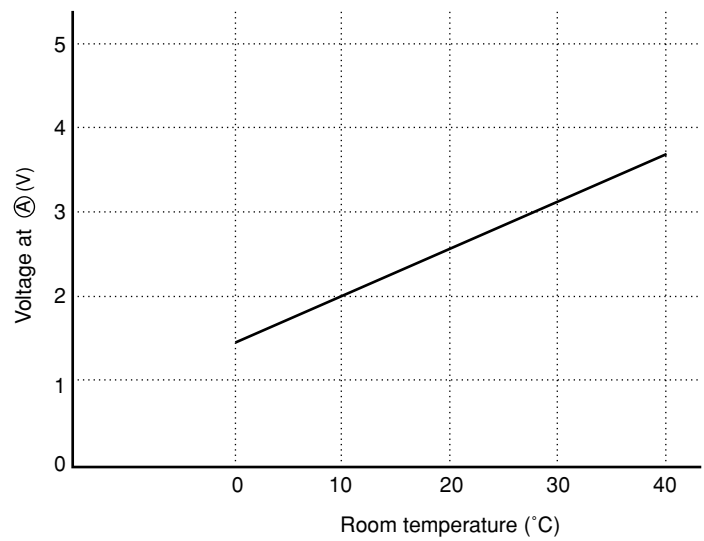

Fig. 5-2

6. Heat exchanger temperature thermistor circuit

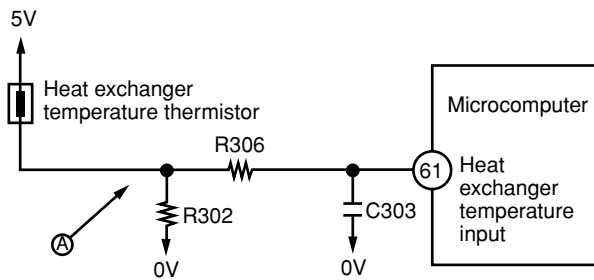

Fig. 6-1

- The circuit detects the indoor heat exchanger temperature and controls the following.

- (1) Preheating.
- (2) Low-temperature defrosting during cooling and dehumidifying operation.
- (3) Detection of the reversing valve non-operation or heat exchanger temperature thermistor open.

The voltage at (A) depends on the heat exchanger temperature as shown in Fig. 6-2.

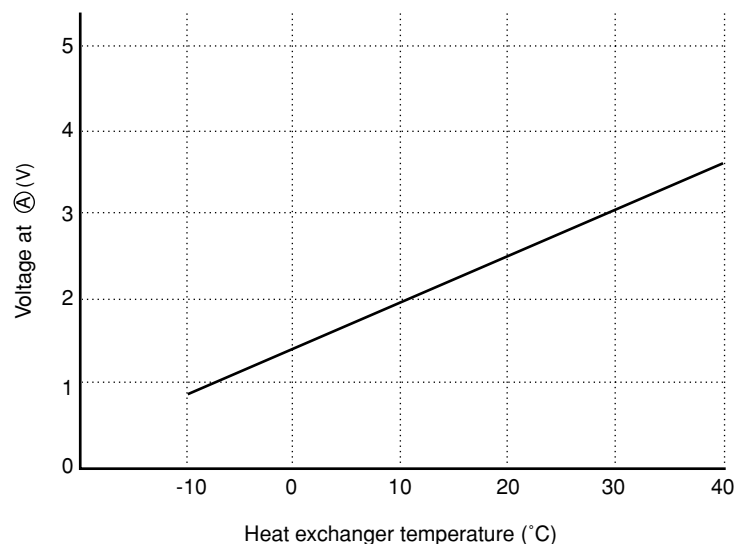

Fig. 6-2

7. Initial Setting Circuit (IC401)

- When power is supplied, the microcomputer reads the data in IC401 (E²PROM) and sets the preheating activation value and the rating and maximum speed of the compressor, etc. to their initial values.
- Data of self-diagnosis mode is stored in IC401; data will not be erased even when power is turned off.

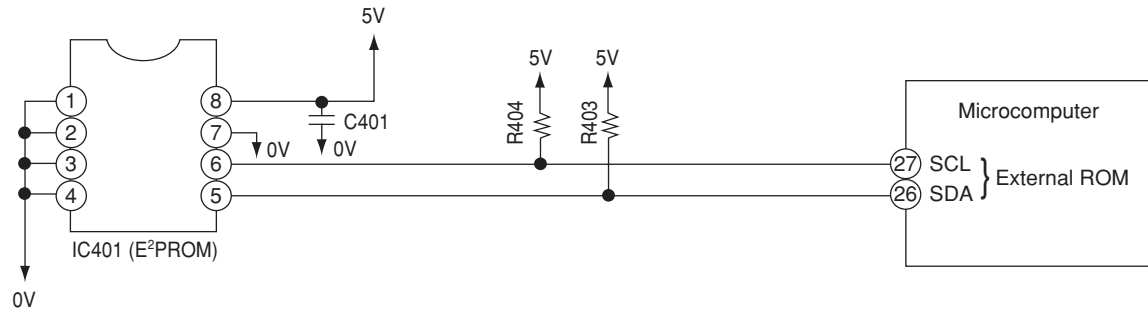

Fig. 7-1

SERVICE CALL Q & A

Model RAI-25NH5
RAI-35NH5

COOLING MODE

Q1) The compressor has stopped suddenly during cooling operation.



A1) Check if the indoor heat exchanger is frosted. Wait for 3-4 minutes until it is defrosted.

If the air conditioner operates in cooling mode when it is cold, the evaporator may get frosted.

DEHUMIDIFYING MODE

Q2) Sound of running water is heard from indoor unit during dehumidifying.



A2) Normal sound when refrigerant flows in pipe.

Q3) Compressor occasionally does not operate during dehumidifying.



A3) Compressor may not operate when room temperature is 10°C or less. It also stops when the humidity is preset humidity or less.

HEATING MODE

Q4) The circulation stops occasionally during Heating mode.



A4) It occurs during defrosting. Wait for 5-10 minutes until the condenser is defrosted.

Q5) When the fan speed is set at HIGH or MED, the flow is actually Weak.



A5) At the beginning of heating, the fan speed remains LOW for 30 seconds. If HIGH is selected, it switches to LOW and again to MED after additional 30 seconds.

Q6) Heating operation stops while the temperature is preset at "30".



A6) If temperature is high in the outdoor, heating operation may stop to protect internal devices.

AUTO FRESH DEFROSTING

Q7) After the ON/OFF button is pressed to stop heating, the outdoor unit is still working with the OPERATION lamp lighting.



A7) Auto Fresh Defrosting is carried out : the system checks the outdoor heat exchanger and defrosts it as necessary before stopping operation.

AUTO OPERATION

Q8) Fan speed does not change when fan speed selector is changed during auto operation.



A8) At this point fan speed is automatic.

NICE TEMPERATURE RESERVATION

Q9) When on-timer has been programmed, operation starts before the preset time has been reached.



A9) This is because "Nice temperature reservation" function is operating. This function starts operation earlier so the preset temperature is reached at the preset time. Operation may start maximum 60 minutes before the preset time.

Q10) Does "Nice temperature reservation" function operate during dehumidifying?



A10) It does not work. It works only during cooling and heating.

Q11) Even if the same time is preset, the operation start time varies.



A11) This is because "Nice temperature reservation" function is operating. The start time varies according to the load of room. Since load varies greatly during heating, the operation start time is corrected, so it will vary each day.

INFRARED REMOTE CONTROL

Q12) Timer cannot be set.



A12) Has the clock been set? Timer cannot be set unless the clock has been set.

Q13) The current time display disappears soon.



A13) The current time disappears in approx. 10 seconds. The time set display has priority.

When the current time is set the display flashes for approx 3 minutes.

Q14) The timer has been programmed, but the preset time disappears.



A14) Is the current time past the preset time? When the preset time reaches the current time, it disappears.

OTHERS

Q15 The indoor fan varies among high air flow, low air flow and breeze in the auto fan speed mode. (Heating operation)



A15 This is because the cool wind prevention function is operating, and does not indicate a fault.

The heat exchanger temperature is sensed in the auto speed mode. When the temperature is low, the fan speed varies among high air flow, low air flow and breeze.

Q16 Loud noise from the outdoor unit is heard when operation is started.



A16 When operation is started, the compressor rotation speed goes to maximum to increase the heating or cooling capability, so noise becomes slightly louder. This does not indicate a fault.

Q17 Noise from the outdoor unit occasionally changes.



A17 The compressor rotation speed changes according to the difference between the thermostat set temperature and room temperature. This does not indicate a fault.

Q18 There is a difference between the set temperature and room temperature.



A18 There may be a difference between the set temperature and room temperature because of construction of room, air current, etc. Set the temperature at a comfortable for the space.

Q19 Air does not flow immediately after operation is started.



A19 Preliminary operation is performed for one minute when the power switch on and heating or dehumidifying is set. The operation lamp blinks during this time for heating. This does not indicate a fault.







TROUBLESHOOTING WHEN TIMER LAMP BLINKS.

Model RAI-25NH5, RAI-35NH5

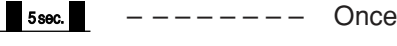
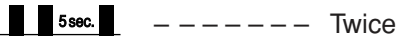
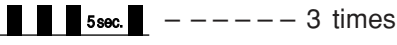
Perform troubleshooting according to the number of times the indoor timer lamp and outdoor LD301 blink.

SELF-DIAGNOSIS LIGHTING MODE

Model: RAI-25NH5, RAI-35NH5

No.	Timer indicator flashing mode	Reason for display	Section of estimated fault
1	 Once	Four-way valve faulty The room heat exchange temperature is low during heating, or it is high during cooling.	(1) Four-way valve faulty. (2) Disconnection in heat exchange thermistor (only during heating)
2	 Twice	Outdoor unit forced operation The outdoor unit is in forced operation or undergoing balancing after forced operation.	Service SW in outdoor electrical parts turned ON.
3	 3 times	Indoor/outdoor interface faulty The interface signal from the outdoor unit has been interrupted.	(1) Indoor interface circuit (2) Outdoor interface circuit
4	 -- 4 times	Outdoor electrical assembly defective.	Please check at the outdoor electrical led lamp blinking (LD301) and refer to self diagnosis lighting mode for outdoor unit.
5	 -- 6 times	Abnormal water level detection All stop when the float switch has been activated.	(1) Drain stopped up (2) Drain pump (3) Float switch
6	 -- 7 times	Drain pump forced operation. When the knob of drain pump test switch at Indoor P.W.B main slide to 'test' position.	(1) Indoor P.W.B. Main.
7	 -- 9 times	Room thermistor or heat exchanger thermistor is faulty When room thermistor or heat exchanger thermistor is opened circuit or short circuit.	(1) Room thermistor (2) Heat exchanger thermistor
8	 -- 10 times	DC fan motor overcurrent detection Overcurrent in indoor DC fan motor has been detected.	(1) Indoor fan locked (2) Indoor fan motor (3) Indoor P.W.B. Main
※1 9	 -- 13 times	IC401 data reading fault There was error in the data read from IC401	IC401 faulty

( -- Lights for 0.5 sec. at interval of 0.5 sec..)

<Cautions>

- (1) If the interface circuit is faulty when power is supplied, the self-diagnosis display will not be displayed.
- (2) If the indoor unit does not operate at all, check to see if the F-cable is connected or disconnected.
- (3) To check operation again when the timer lamp is blinking, you can use the remote control for operation (except for mode mark ※1).

CHECKING INDOOR UNIT ELECTRICAL PARTS

1. Power does not come on (no operation)

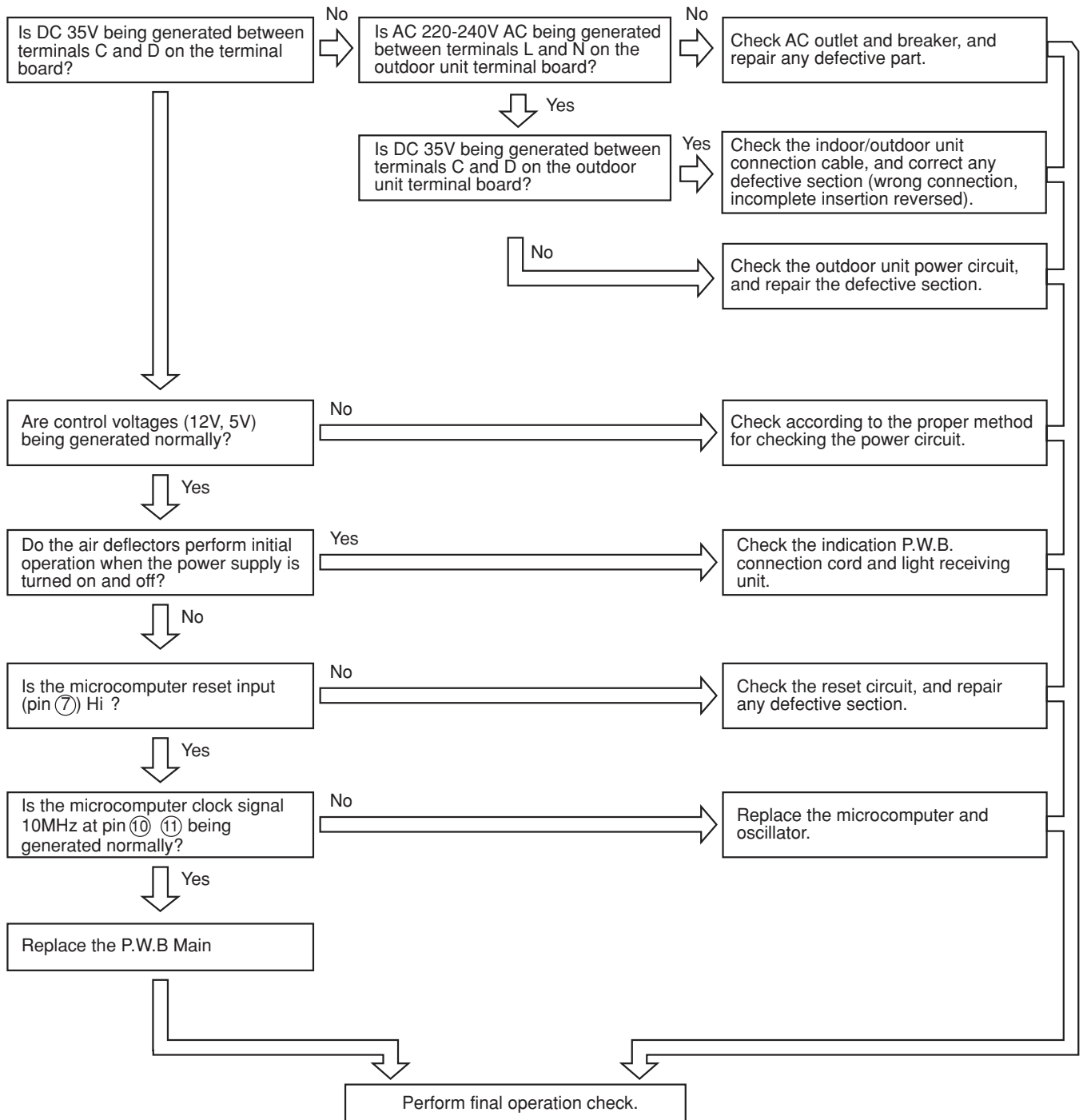

2. Only indoor fan does not operate (other is normal)

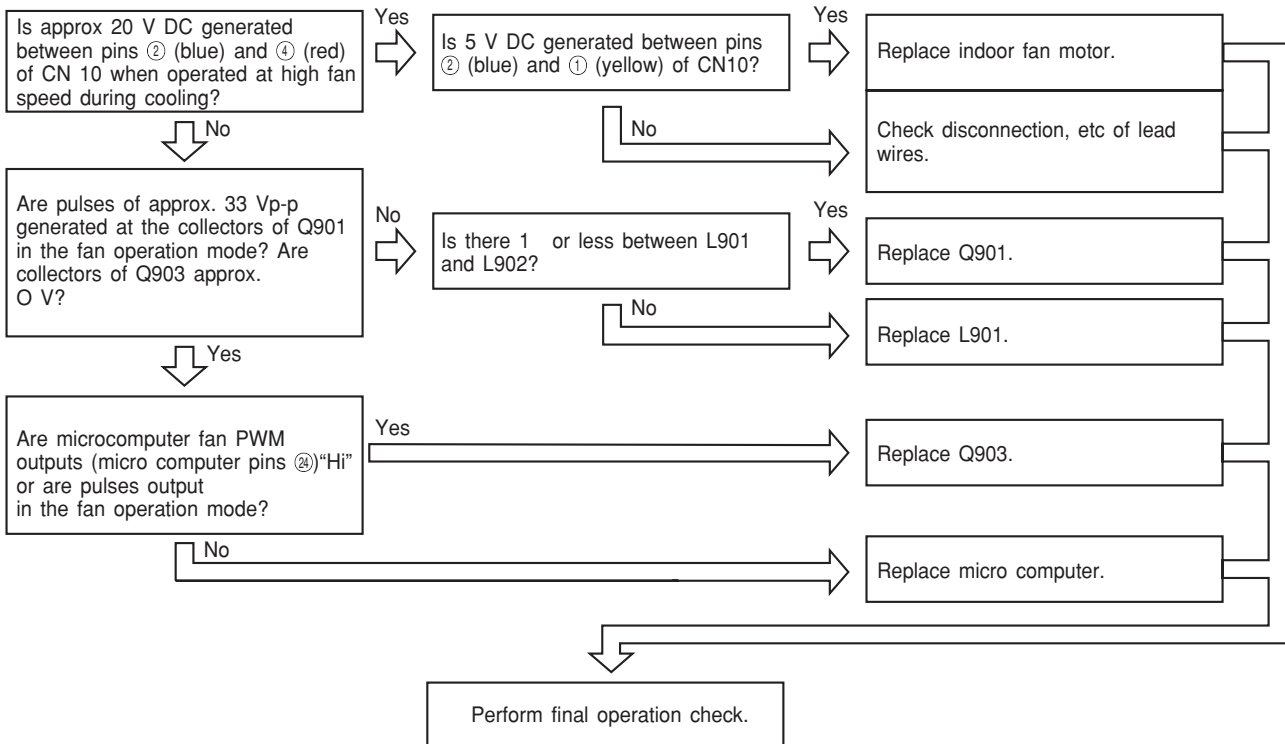

3. Indoor fan speed does not change (other is normal)

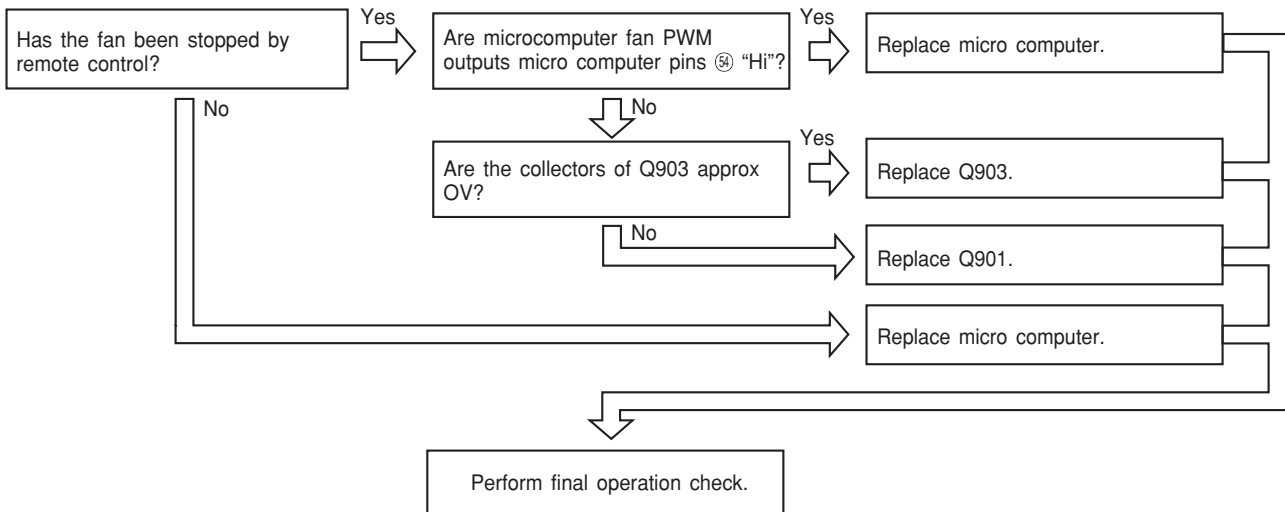

4. Air deflector does not move (other is normal)

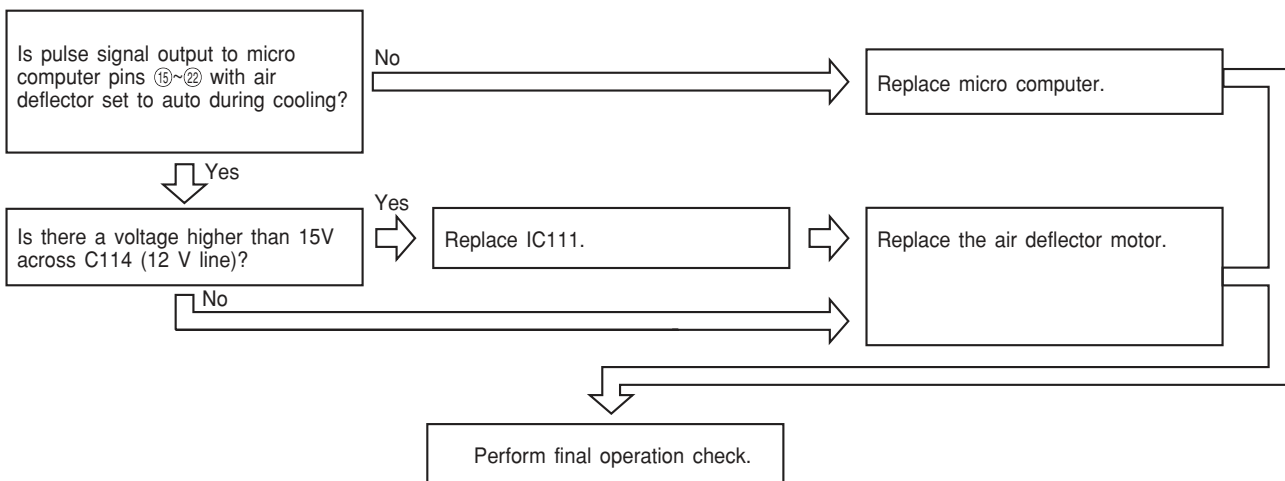

5. All systems stop from several seconds to several minutes after operation is started (all indicators are also off)

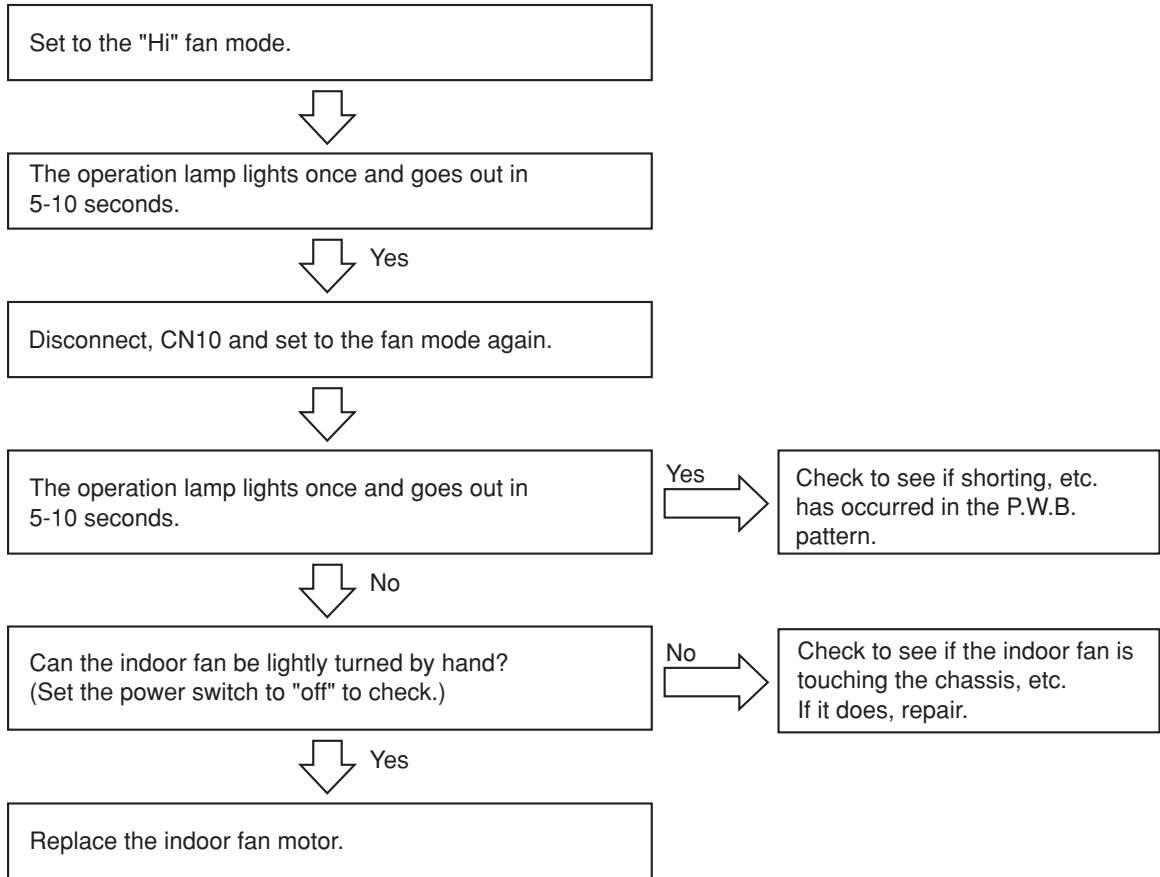

CHECKING THE REMOTE CONTROLLER

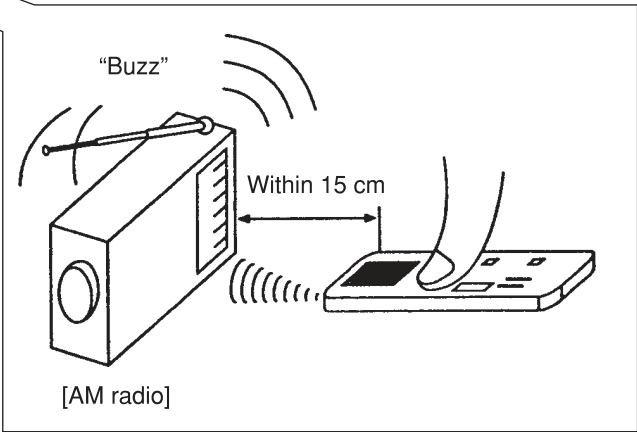
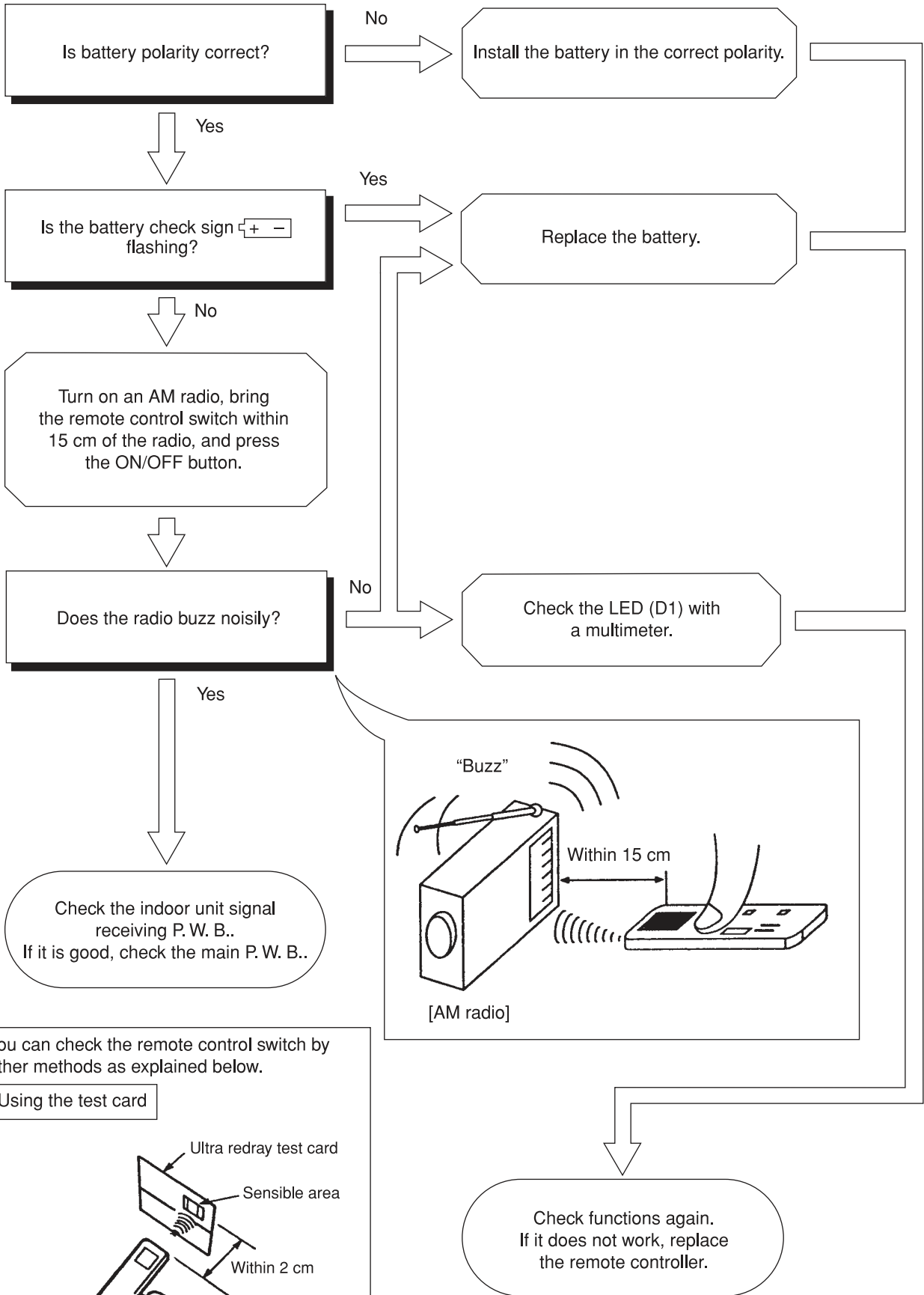

You can check the remote control switch by other methods as explained below.

Using the test card

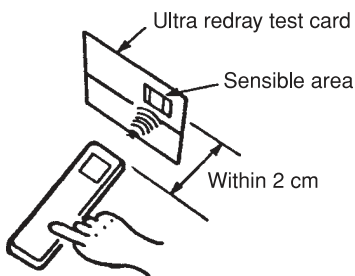

The sensible area should flash in orange when you operate the remote control unit if it is good.

PARTS LIST AND DIAGRAM

INDOOR UNIT

MODEL : RAI-25NH5

RAI-35NH5

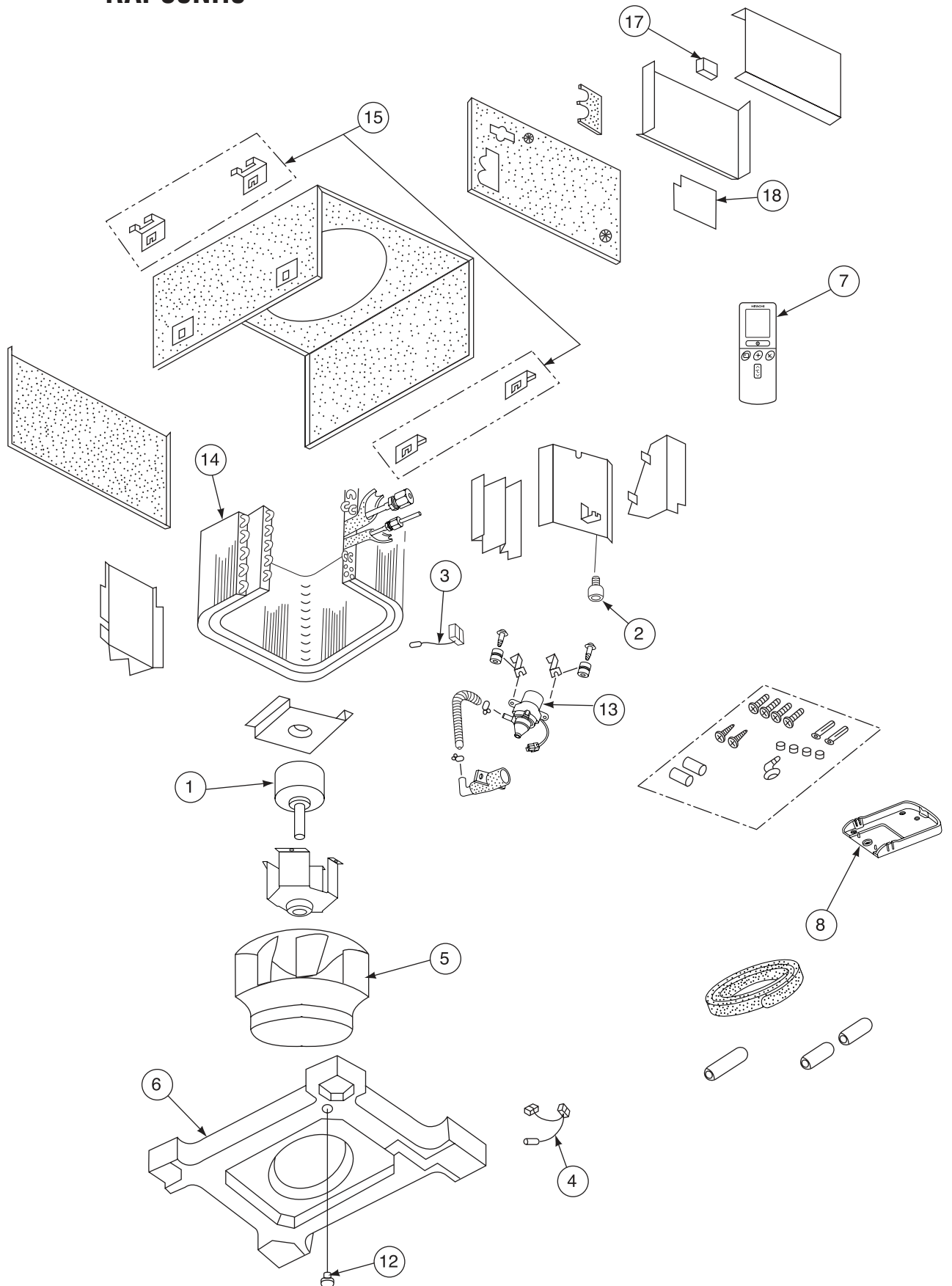

MODEL RAI-35NH5

NO.	PART NO. RAI-35NH5	Q'TY / UNIT	PARTS NAME
1	PMRAI-25NH4R R01	1	25W MOTOR
2	RAMD-350BW 011	1	FLOAT SWITCH
3	PMRAI-32CNH2 R02	1	THERMISTOR (HEAT EXCHANGER)
4	PMRAI-32CNH2 R03	1	THERMISTOR (ROOM TEMPERATURE)
5	PMRAI-32CNH2 004	1	TURBO FAN
6	PMRAI-32CNH2 R05	1	DRAIN PAN ASSEMBLY
7	PMRAS-51CHA1 011	1	REMOTE CONTROL ASSEMBLY
8	PMRAS-10C3M 003	1	REMOTE CONTROL SUPPORT
12	PMRAI-32CNH2 010	1	DRAIN CAP
13	PMRAI-25NH4 R04	1	DRAIN PUMP ASSEMBLY
14	PMRAI-25NH4 R03	1	CYCLE ASSEMBLY
15	PMRAI-25NH4 007	4	SUSP. CLAMP
17	PMRAS-10C6M R02	1	TERMINAL BOARD (2P)
18	PMRAI-35NH5 R01	1	P.W.B. (MAIN)

HITACHI

RAI-25NH5
RAI-35NH5

PM NO. 0271E

Printed in Malaysia