

AUX
AIR CONDITIONER

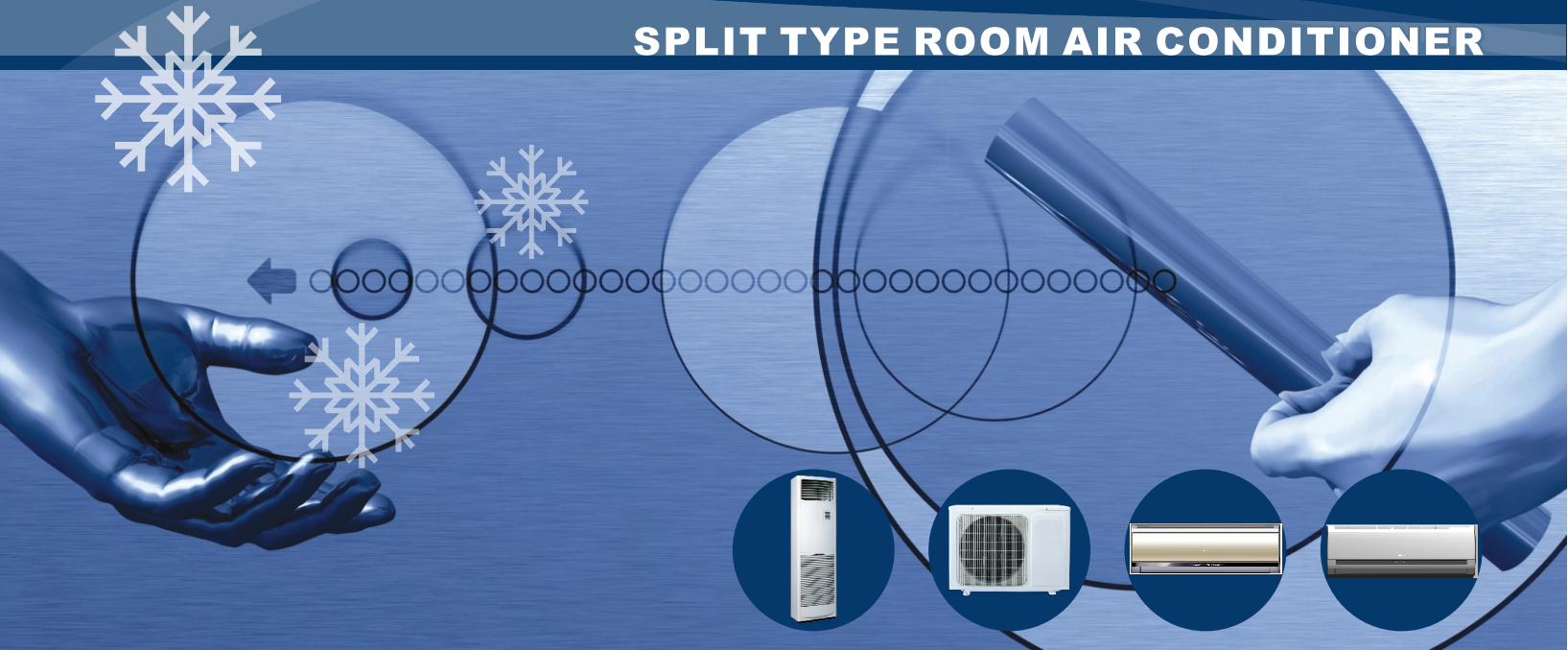

SPLIT TYPE ROOM AIR CONDITIONER



**FOR Split Wall Mounted
Series R410a DC Inverter
ASW-H09A4/SAR1DI
ASW-H12A4/SAR1DI**

Service Manual

2008 [版]
技术服务手册

CONTENTS

Product Specifications.....	1
Dimensions.....	2
Refrigeration Cycle Diagram.....	3
Remote Controller Instructions.....	4
Brief Introduction Of Installation.....	16
Wiring Diagram.....	20
Operation Details.....	22
Disassembly Of The Parts.....	36
Exploded Pictures.....	40

Product Specifications

Item		Model Name		
		<i>ASW-H09A4/SAR1DI</i>	<i>ASW-H12A4/SAR1DI</i>	
Cooling Capacity		BTU/h	9000(4947-10918)	12000(5459-12624)
Heating Capacity			9400(4777-11260)	12000(5459-14330)
Input	Cooling	W	820(380-1350)	950(500-1500)
	Heating		950(380-1540)	1150(430-1600)
Rated Current	Cooling	A	3.57(1.50-5.90)	4.12(1.70-6.50)
	Heating		4.13(1.70-6.70)	5.00(1.90-7.00)
E.E.R	Cooling	BTU/h.W	10.4(8.09-13.0)	11.5(8.4-10.9)
	Heating		9.88(7.31-12.6)	10.4(9.0-12.7)
Dehumidifying		Kg/h	1.2	1.4
Power-Supply		φ--V--Hz	1/220-240~/50	
Air Circulation	Indoor	m ³ /h	420	580
	Outdoor		800	800
Noise Level	Indoor	dB	39	42
	Outdoor		53	53
Motor Input	Indoor	W	19	19
	Outdoor		35	35
Dimension(WxHxD)	Indoor	mm	802*265*185	880*286*196
	Outdoor		818*320*540	818*320*540
Net Weight	Indoor	kg	9.5	11
	Outdoor		36	36
Connection Pipe(OD*L)	Liquid	mm	φ6.35×3600	φ6.35×3600
	Gas		φ9.52×3600	φ9.52×3600
Refrigerant(R-410A)		g	900	1100
Operation control		LCD Wireless remote		

Dimensions

(1) Indoor unit

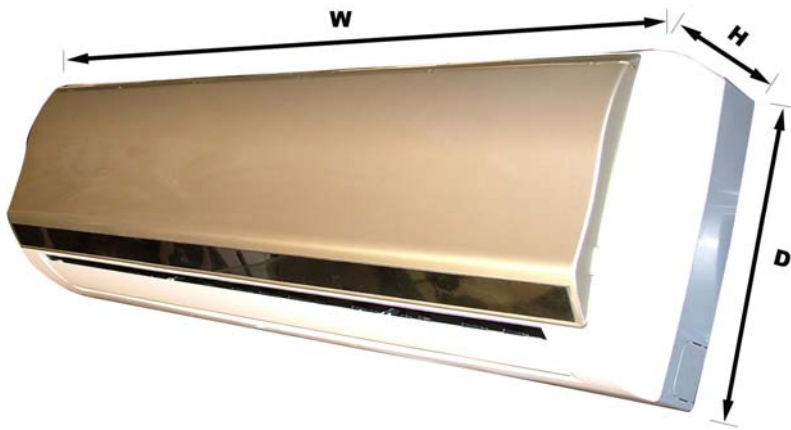

DIM \ MODEL		MODEL	
		<i>ASW-H09A4/SAR1DI</i>	<i>ASW-H12A4/SAR1DI</i>
W	mm	802	880
H	mm	185	196
D	mm	265	286

(2) Outdoor unit

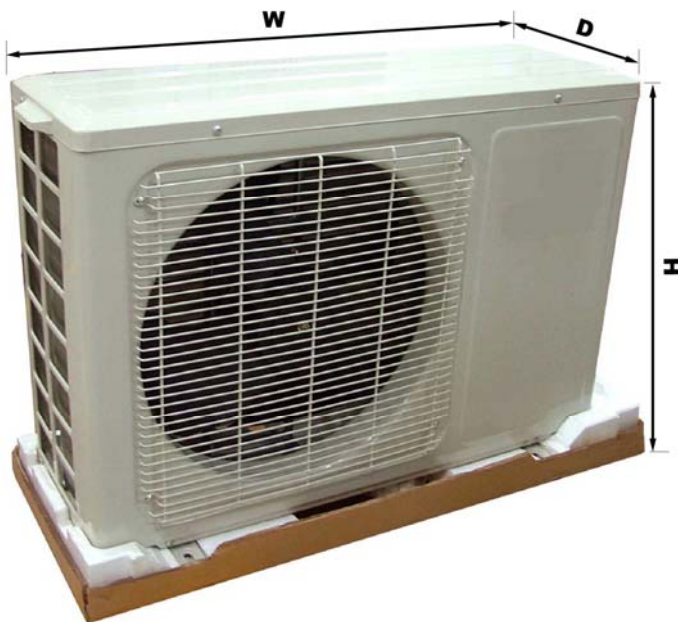

DIM \ MODEL		MODEL	
		<i>ASW-H09A4/SAR1DI</i>	<i>ASW-H12A4/SAR1DI</i>
W	mm	760	760
H	mm	540	540
D	mm	260	260

Refrigeration Cycle Diagram

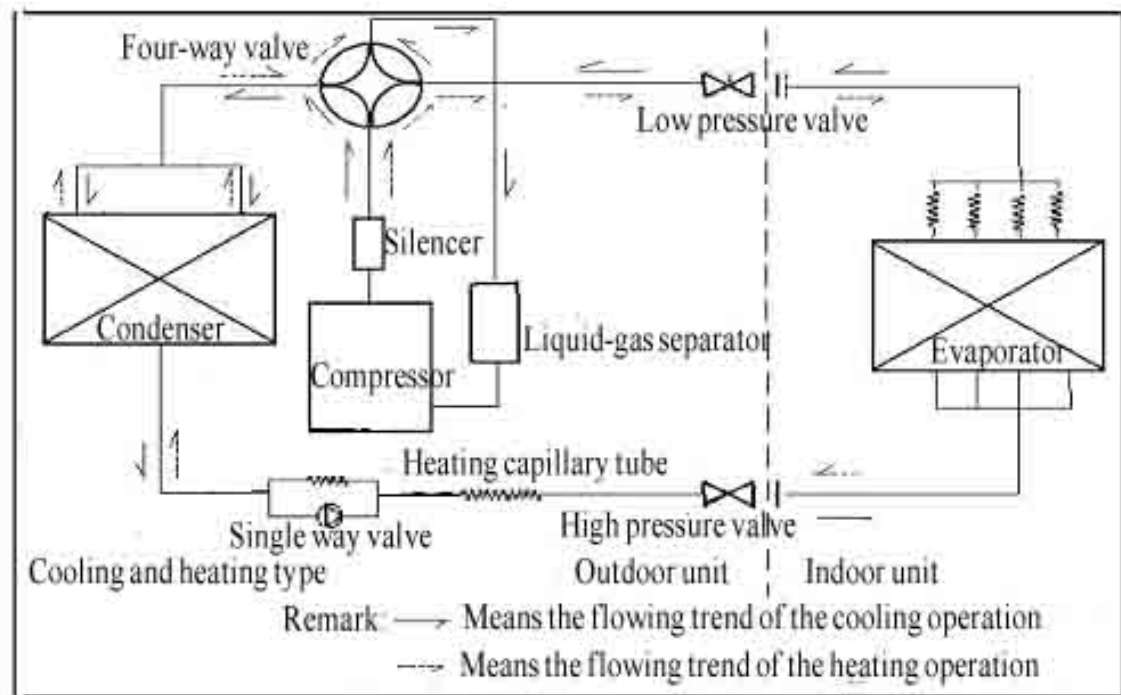
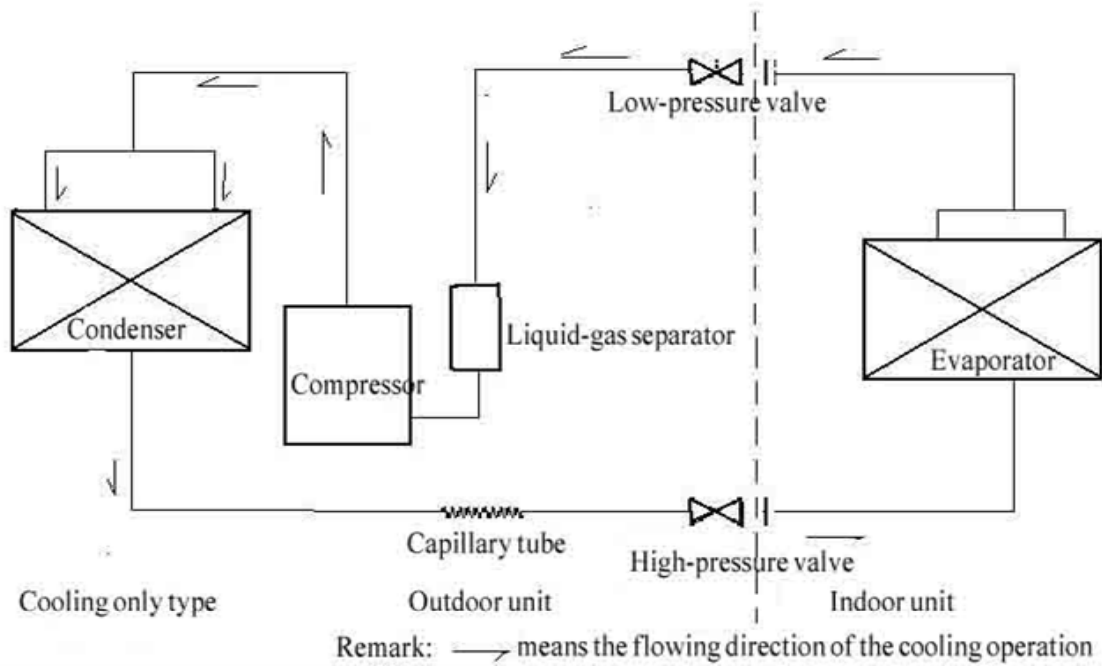

MODEL	Pipe size (Diameter: \varnothing)		Max. Piping Length (m)	Max. Elevation (m)
	Liquid(inch)	Gas(inch)		
ASW-H09A4/SAR1DI	1/4	3/8	15	3-4
ASW-H12A4/SAR1DI	1/4	3/8	15	3-4

AIR-CONDITIONER REMOTE CONTROLLER

INSTRUCTIONS



- Read this “instructions” carefully so that you can use the air-conditioner safely and correctly.
- Take good care of the “instructions” so that it can be referred to at any time.

Names and functions of the buttons

The closing state of remote controller:

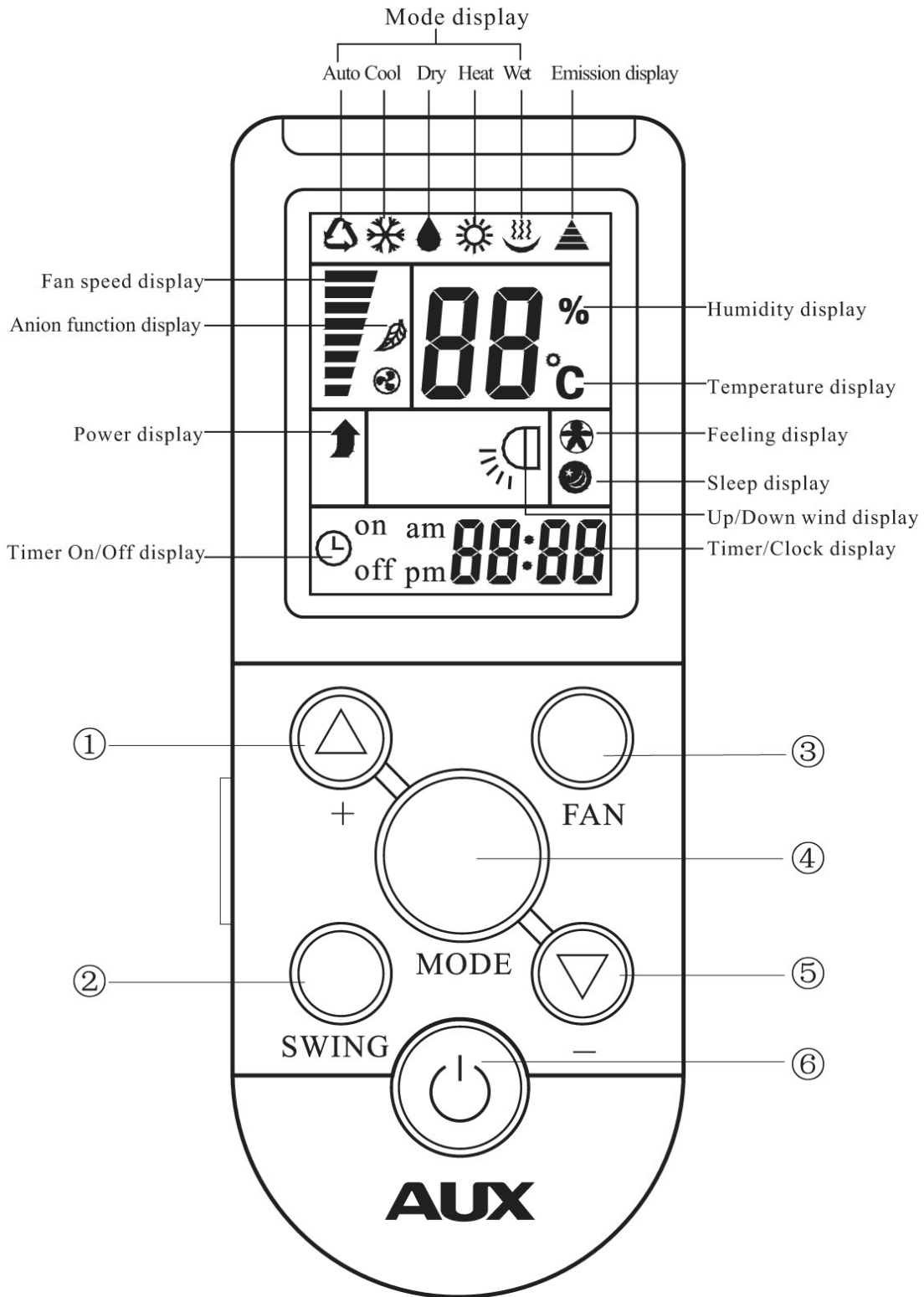

① “ + ” **button**

This button can set room temperature.

Press it once, the temperature increases 1°C. Press it continuously, the temperature increases at the speed of 4°C/s.

This function is invalid when the appliance is at the Fan and Auto mode.

② “**SWING**” **button**

Press the button, the LCD shows the “” symbol, the horizontal airflow direction plate can adjust automatically.

When you have the desired wind direction, please press it again, the airflow direction plate will stop at the situation.

③ “**FAN**” **button**

You can select fan speed show as the follow:

The type of E series:



The type of H、M series:

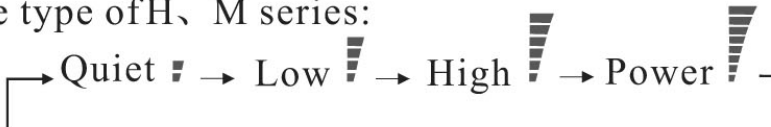

④ “**MODE**” **button**

Which enables you to select different operation mode, after each pressing, the operation mode will be changed. It shows in the following display.



Remark: Cold wind type has no heating function.

⑤ “ - ” **button**

This button can set room temperature.

Press it once, the temperature decreases 1°C. Press it continuously, the temperature decreases at the speed of 4°C/s.

This function is invalid when the appliance is at the Fan and Auto mode.

⑥ “” **Button**

You can start the air-conditioner by pressing this button and stop its operation by pressing it again.

The opening state of remote controller:

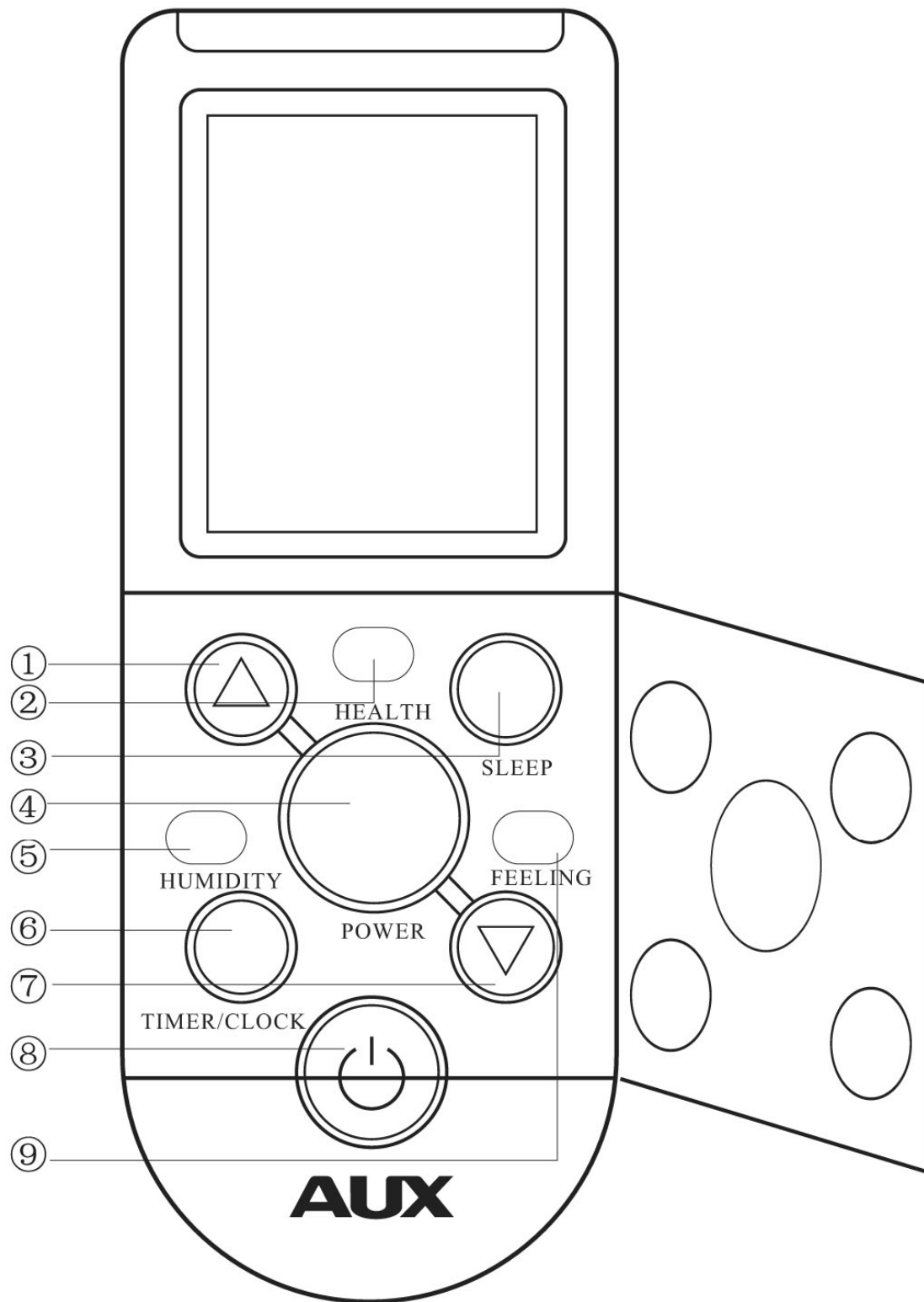

① “” button

This button not only can adjust clock time and the timer time but also can set room humidity.

Adjusting clock time and timer time

Press it once, the time increases one minute. Press it for 1 to 3 seconds, time display will increase at the speed of 2min/s. For 3 to 5 seconds, it will increase at the speed of 10min/s. For more than 5 seconds, it will increase at the speed of 10min/s.

Setting room temperature and room humidity

Press it once, the humidity increases 5%.

② “HEALTH” button

Press this button, the LCD shows the “” symbol, the anion emission function of the air conditioner is started.

Press the button once again, The “” symbol disappears, the function is cancelled at the same time.

③ “SLEEP” button

Press this button, the LCD shows the “” symbol, the sleeping function of the air conditioner is started. After 7 hours of setting this function, the air conditioner will be off automatically.

Press the button once again, The “” symbol disappears, the function is cancelled at the same time.

This function is invalid when the appliance under the Fan mode.

④ “POWER” button

☆ When it displays “POWER” button:

Press this button, the fan speed reach the highest, press it again it resume the foregoing fan speed.

Note: 1. This function is valid only on HEAT or COOL mode.



2. This function is invalid on H、M series product.

Screen display setting

1. Press the “POWER” for 3 seconds, it will display the state of the air conditioner through LED、LCD、or VFD.

2. Press it for 3 seconds again, it will cancel the screen display.

⑤ “HUMIDITY” button

Only under the mode of Heat and Fan, Press this button once, the LCD shows the “” symbol, the wetting function of the air conditioner is started. The initial humidity is 60%. Press the “” or “” button once, the humidity increases or decreases 5%. The setting range is 30%~60%.

Press the button once again, The “” symbol disappears, the function is cancelled at the same time.

⑥ “TIMER/CLOCK” button

Setting the “ON/OFF” timer time

When remote controller is at the on/off state, Press this button, the LCD flickers the “ $\text{Ⓛ}_{\text{off}}/\text{Ⓛ}_{\text{on}}$ ” symbol. Press the “ Ⓢ ” or “ Ⓣ ” button to set the timer time. After finishing it, press this button again in 10 seconds to affirm. If the setting time is the same as the current time, this setting is invalid.

Press the button once more, The “ $\text{Ⓛ}_{\text{off}}/\text{Ⓛ}_{\text{on}}$ ” symbol disappears, the function is cancelled at the same time. “ ” “ ”

Adjusting the clock time

Press this button in 5 seconds Under the state of no timer setting , the LCD flickers the “ $\text{am/pm } \text{ⓈⓈ}:\text{ⓈⓈ}$ ” symbol. Press the “ Ⓢ ” or “ Ⓣ ” button to set the timer time. After finishing it, press this button again in 10 seconds to affirm. If not, this operation is invalid.

⑦ “ Ⓣ ” button

This button not only can adjust clock time and the timer time but also can set room humidity.

Adjusting clock time and timer time

Press it once, the time decreases one minute. Press it for 1 to 3 seconds, time display will decrease at the speed of 2min/s. For 3 to 5 seconds, it will decrease at the speed of 10min/s. For more than 5 seconds, it will decrease at the speed of 10min/s.

Setting room temperature and room humidity

Press it once, the humidity decreases 5%.

⑧ “ Ⓛ ” button

You can start the air-conditioner by pressing this button and stop its operation by pressing it again.

⑨ “FEELING” button

☆ When it displays “FEELING” button:

Press this button can be used to set the feeling function.

The LCD shows the actual room temperature when the function set and it shows the setting temperature when the function cancelled. This function is invalid when the appliance at the Fan mode.

Application method

★ Fix batteries



1. Slide open the cover according the direction indicated by arrowhead.
2. Put into two brand new batteries (7#), position the batteries to right electric poles (+&-).
3. Put back the cover.

Remark: Make sure to connect the wire to independent power source socket before you use the remote controller.

★ Cooling /Heating operation mode

(Cold wind type has no heating function)

1. Press the “” button, the operation indicator is on, the air conditioner starts to operate the Cooling or Heating mode. Press the button again, the air-conditioner stops.
2. Press the **MODE** button, select the Cooling or Heating operation mode.
3. Press the “+” or “-” button, you can set the temperature range from 16°C to 32°C.
4. Press the **FAN** button, you can select fan speed from “Low”, “Med”, “High”, “Auto” .

★ Drying operation mode

1. Press the **MODE** button, select the dry mode operation.
2. Press the “+” or “-” button, you can set the temperature range from 16°C to 32°C.
3. Press the **FAN** button, you can select fan speed.

The type of H、 M series:

You can select fan speed from “Power”, “High”, “Low”, “Mute” .

The type of E series:

You can select fan speed from “Auto”, “High”, “Mid”, “Low” .

★ Circulation operation mode

1. Press the **MODE** button, select the fan operation mode.

2. Press the **FAN** button, you can select fan speed.

The type of H、 M series:

You can select fan speed from “High”, “Low”, “Mute” .

The type of E series:

You can select fan speed from “High”, “Mid”, “Low” .

Remark: In the fan operation mode, to set the temperature is noneffective.

★ Automatic operation mode

1. Press the **MODE** button, select the automatic operation mode.

2. Press the **FAN** button, you can select fan speed.

The type of H、 M series:

You can select fan speed from “Power”, “High”, “Low”, “Mute” .

The type of E series:

You can select fan speed from “Auto”, “High”, “Mid”, “Low” .

Remark: In the fan operation mode, to set the temperature is noneffective.

★ Clock time setting

1. Press the **TIMER/CLOCK** button for 5 seconds, the time indicator at present begins to glimmer.

2. Adjust present time through pressing the “+” or “-” button.

3. Press the **TIMER/CLOCK** button once again, the time setting is finished.

Remark : Time can be regulated only after the timing mode is cancelled .

★ Timer setting

☆ Set the “ **Timer ON**” (It is effective only when the air conditioner is shut off).

1. Press the **TIMER/CLOCK** button , the remote controller display “ⓐ^{on}” immediately.

2. Adjust time through pressing the “+” or “-” button.

3. Press the **TIMER/CLOCK** button again, the “**Timer ON**” setting is finished.

- ☆ Set the “Timer OFF” . (It is effective only when the air-conditioner is running.)
 1. Press the **TIMER/CLOCK** button ,the remote controller display “ \odot_{off} ” immediately.
 2. Adjust time through pressing the “ + ” or “ - ” button.
 3. Press the **TIMER/CLOCK** button again, the “**Timer OFF**” setting is finished.

★ Sleeping operation mode

1. Press the **SLEEP** button, the sleeping indicator light of indoor unit flashes on.
2. After the setting of sleeping mode, the cooling operation enables the set temperature to increase 1°C after 1 hour and another 1°C automatically after 1 hour.
3. After the setting of sleeping mode, the heating operation enables the set temperature to drop 2°C after 1 hour and another 2°C automatically after 1 hour.
4. The air-conditioner runs in sleeping mode for 7 hours and stops automatically.

Remark: Press the **MODE** button or **ON/OFF** button, the remote controller clears sleeping mode away.

Attention

- ★ Aim the remote controller towards the receiver on the air-conditioner .
- ★ The remote controller should be within 8 meters away from the receiver.
- ★ No obstacles between the remote controller and receiver.
- ★ Don't drop or throw the remote controller.
- ★ Don't put the remote controller under the forceful sunrays or heating facilities and other heating sources.
- ★ Use two 7# batteries, don't use the electric batteries.
- ★ Take the batteries out of remote controller before stop its using for long.
- ★ When the noise of transmitting signal can't be heard indoor unit or the transmission symbol on the display screen doesn't flare, batteries need be replaced.
- ★ If reset phenomenon occurs on pressing the button of the remote controller, the electric quantity is deficient and new batteries need to be substituted.

Brief Introduction Of Installation

The installation of air-conditioner should meet with the “Installation Instruction”. The machine must be installed correctly by professional technicians according to the “Installation Instruction”.

(1) Guide to customer

- ①The customer should provide a suitable power supply source, its voltage should be in the range of 90-110% of its rated voltage.
- ②The power supply circuit should have MCB leakage protection. The capacity should be more than 1.5 times of the maximum current.
- ③Must use independent circuit and suitable grounding socket matching with the plug of air-conditioner.
- ④The wiring must be installed by qualified electrician according to the electrical safety requirements.
- ⑤The air-conditioner must be well grounded, the switch of the main power of air-conditioner must be reliably grounded.
- ⑥The power supply wire, must be changed by qualified electrician.

(2) Installation Instruction

1. Installation order

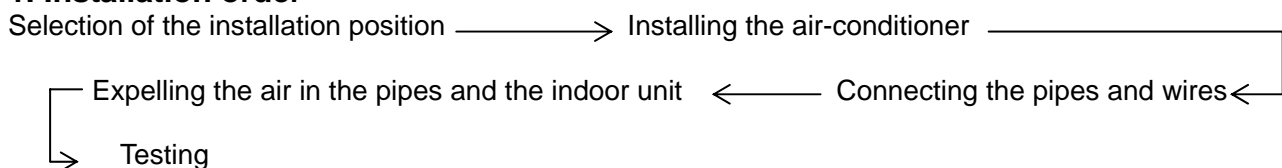

2. Selection of the installation position

Indoor Unit:

- ①There is no heating and steaming source nearby.
- ②No obstacles for installation position from nearby.
- ③Keep good air circulation.
- ④Convenient to adopt measures to reduce noises.
- ⑤Don't install them near the doorway.
- ⑥Make sure to have the distance specified in the picture between the ceiling, wall, furniture and other obstacles.
- ⑦2 meters high above the floor.

Outdoor Unit:

- ①In case that you put up a canopy to protect it from rains and sunrays, pay attention not to cause any obstacles for the heating dispersion for the condenser.
- ②Don't keep animals or plants near the installation location for the hot air from the outdoor unit will affect them.
- ③Make sure to have the distance specified in the picture between ceiling, wall, furniture and other obstacles.
- ④Stay away from heating source and inflammable air.
- ⑤The installation base and supporting frame should be strong and secure. The machine should be at a level surface.

3. Installation

Outdoor Unit:

- ① The outdoor unit must be firmly fixed to avoid falling in strong wind.
- ② Install on the cement base as in the drawing.
- ③ If it is installed at seaside or at a place high above the ground and with strong wind, the AC should be installed against the wall to ensure the normal operation of the fan and the blocking plate should be used.
- ④ If it is an overhanging installation, the structure of the mounting wall should be made of solid, cement or materials with equivalent strength, and of sufficient support capacity. Otherwise, measures such as reinforcement, support or vibration damping should be adopted.

Indoor Unit

- ① First make changes to wall and make sure that is hard and secure. Using four “+” type screws to fasten the installation board onto the wall. Keep it level in horizontal direction and perpendicular in vertical direction. Otherwise it might cause water drips when air-conditioner is running in cooling operation.
- ② Drill 70mm diameter pipe hole at the left lower or right lower side of the installation board. The hole shall slant outward slightly.
- ③ Hang the indoor unit to the oard and make sure the machine is in the middle of the board.
- ④ Push the machine towards the left lower and right lower side of the installation board until the hangers enter tightly into the grooves (it produces “click” sound)

4. Check the water discharge

- (1) Take off the frame from the unit cover.

Take off the front frame for maintenance according to the following steps:

- ① As shown in the picture on the right, take off two covers from the front frame and then unfasten two fixture screws.

- ② Pull the front frame towards yourself and take it off.

To put the front frame back, reverse the steps.

You should check whether the front frame is firmly fixed into the fixture groove on the top.

- (2) Check the water discharge

- ① Pour a cup of water into groove.

- ② Check whether the water flow through the water discharge hole.

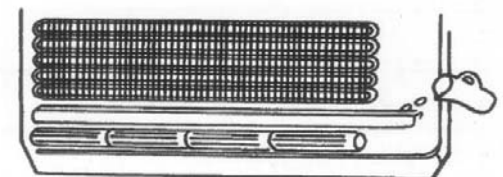
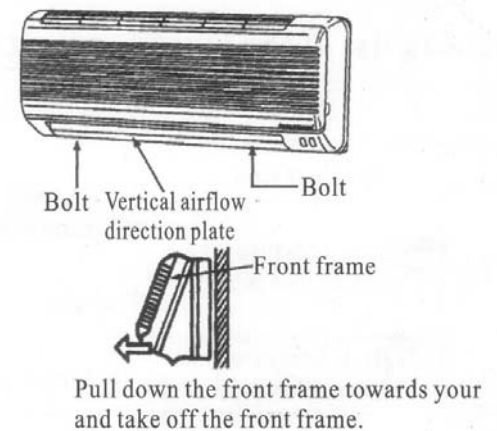
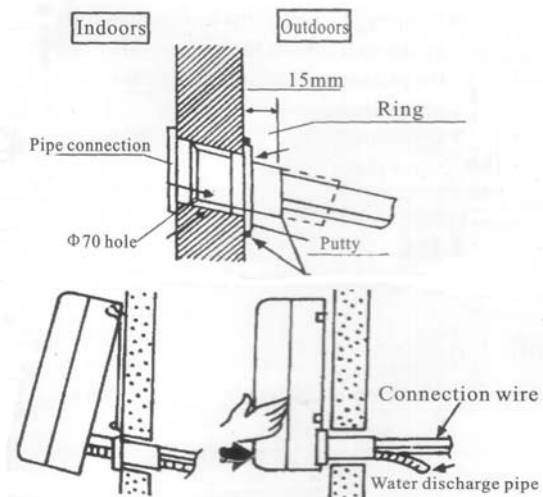
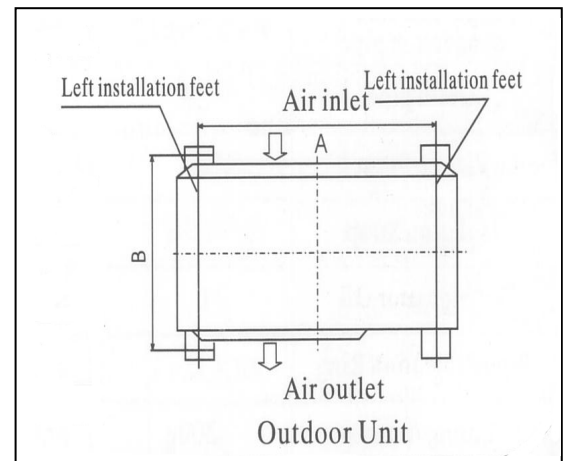

(5)Pipe Connection

- ① Connect the pipe to the unit: point to the center of pipe and fasten the connection screw at first by hand and then by wrench until it is tightly fastened. The fastening direction is shown in the picture.
- ② Pointing towards the center of pipe, fasten the screw with strength.
- ③ Wrench the screw in the end until you hear the “click” sound.

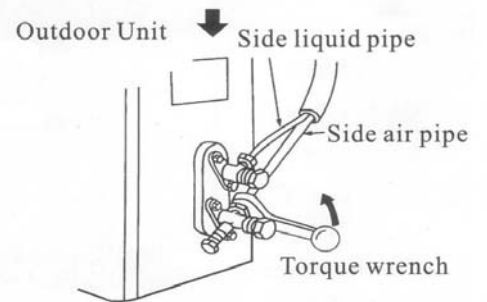
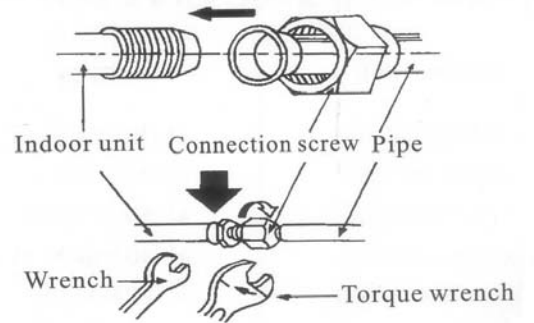
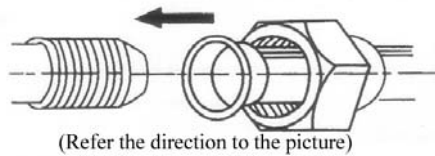

(6)The fixing of pipe

- ① Wrap up all pipe, water discharge and connection wire from top to below.
- ② Cover the connection parts with insulation material and fix them with two plastic rings.
- ③ Wrap up the pipes with tape alongside the wall and fix them to the wall with clips. These steps are usually adopted when outdoor unit is installed below the indoor unit.
- ④ In case that you want to have additional water discharge pipe, the end of pipe should be within certain distance from the floor (to prevent water from draining back into the pipe). Fix it onto the wall so it won't be swayed by wind.
- ⑤ Wrap the pipes and connection wire well from below to top.
- ⑥ Wrap up the pipes that are rounded up in the way shown in the picture so it can prevent water from entering the room.
- ⑦ Use clips or other fixture to fasten the pipes to the walls.

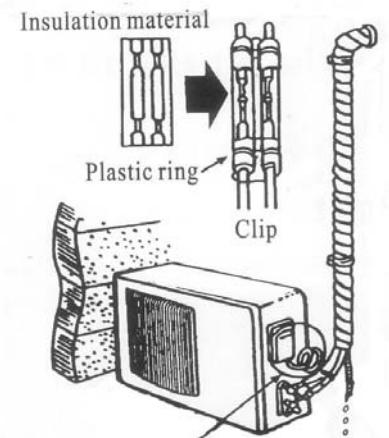

Round in this shape to prevent water entering the electrical parts.

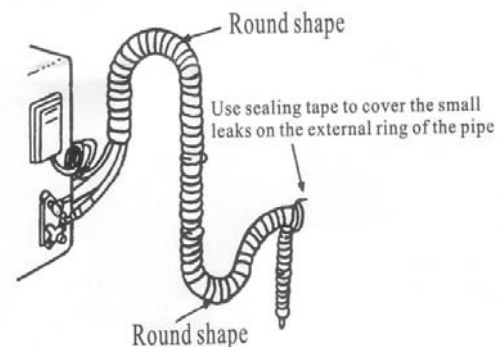

(7)Expelling the air in the pipes and the indoor unit

Expelling the air: humid air in the refrigerating system might cause trouble of compressor.

- ① Take off the cover from the stop valve and T-branch valve.
- ② Take off the auxiliary cover from the T-branch valve.
- ③ Turn the stop valve rod anti-clock wise to an angle of 90 degree, keep it open for 8 seconds and close the valve.
- ④ Check whether there is air leakage at all connection parts of pipes.
- ⑤ Push the top rod of T-branch valve by hexagon wrench to expel air.
- ⑥ Repeat the third and fifth steps.
- ⑦ Open the stop and T-branch valve with a hexagon wrench to make the unit operate.
- ⑧ No leakage is allowed, please check all the piping connection parts. You must test the leakage, generally, it can be tested by soap water.

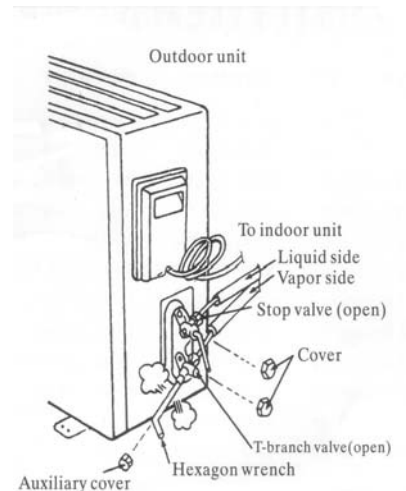

(8)Electrical connection

- ① Unscrew the screw, take off the control panel cover from the unit.
- ② Cooling type: connect the wire to the related connection point on the panel and connect the signal connection plug. Remarks: yellow and green cord should be connected to connection point with  mark.
- ③ Fasten the fixture of wire to control panel.
- ④ Screw up the control panel cover to its original place.

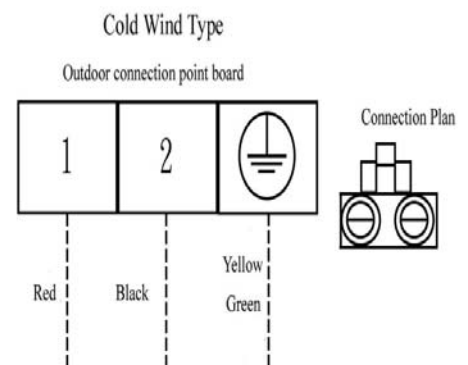

(9)Test running

- ① Make sure that the pipes and wires are connected.
- ② Make sure that both the liquid valve and gas valve on the side are completely open.

The connection of power source

- Connect the wire to independent power source socket.
- Preparation of remote control.
- Run the air-conditioner in cooling operation mode for 30 minutes or longer.

Performance evaluation

- Test the out and in air temperature.
- Make sure that the temperature difference between the out and in air is greater than 8°C.

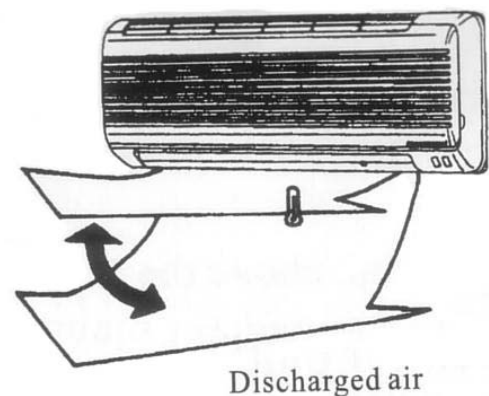

(10)Items of attention

- ① Fix the machine firmly, otherwise it will produce noise and vibration.
- ② Install the outdoor unit where it will not disturb your neighbor.

Wiring Diagram

1. Indoor Unit Electric Chart

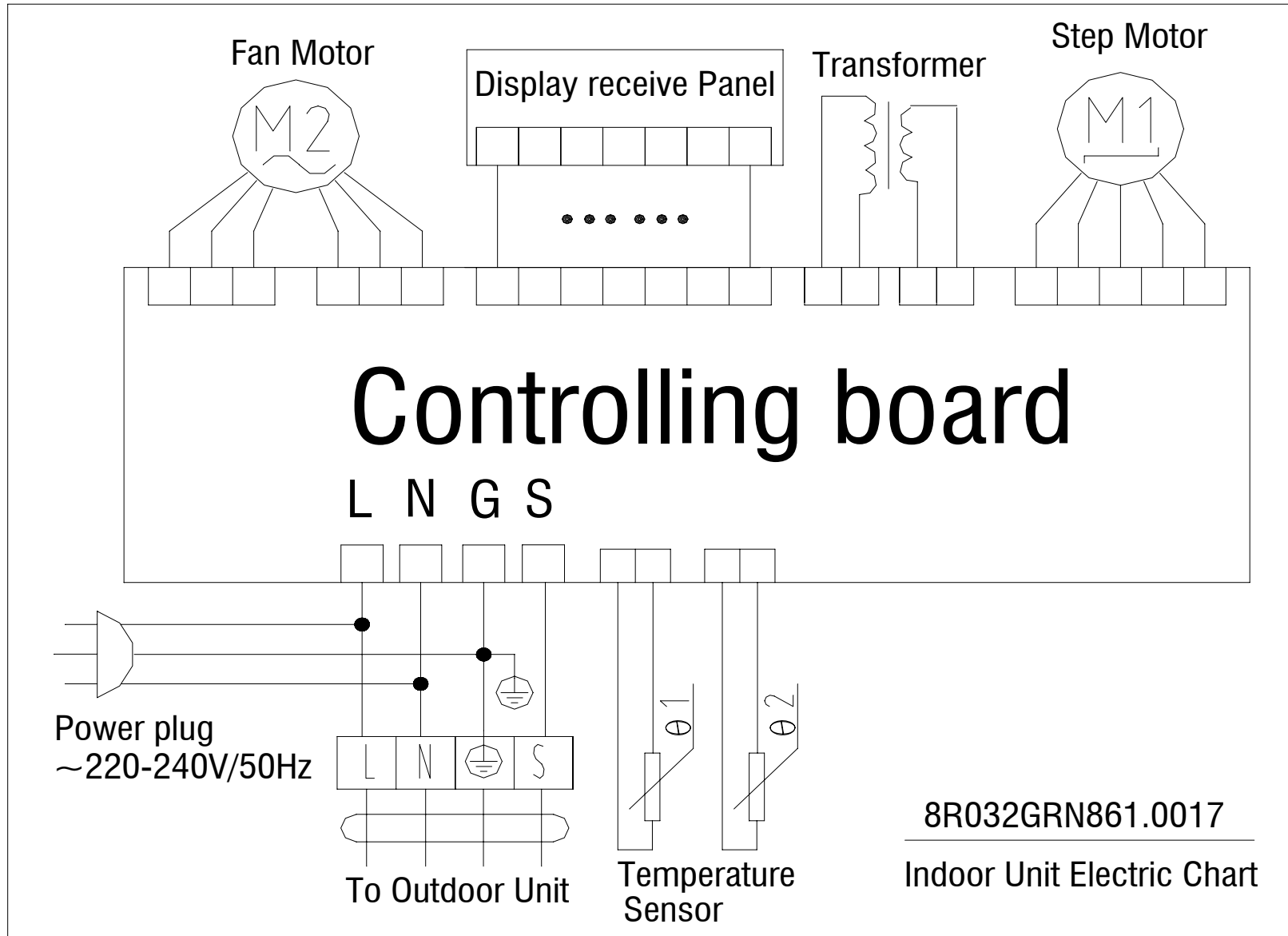

2. Outdoor Unit Electric Chart

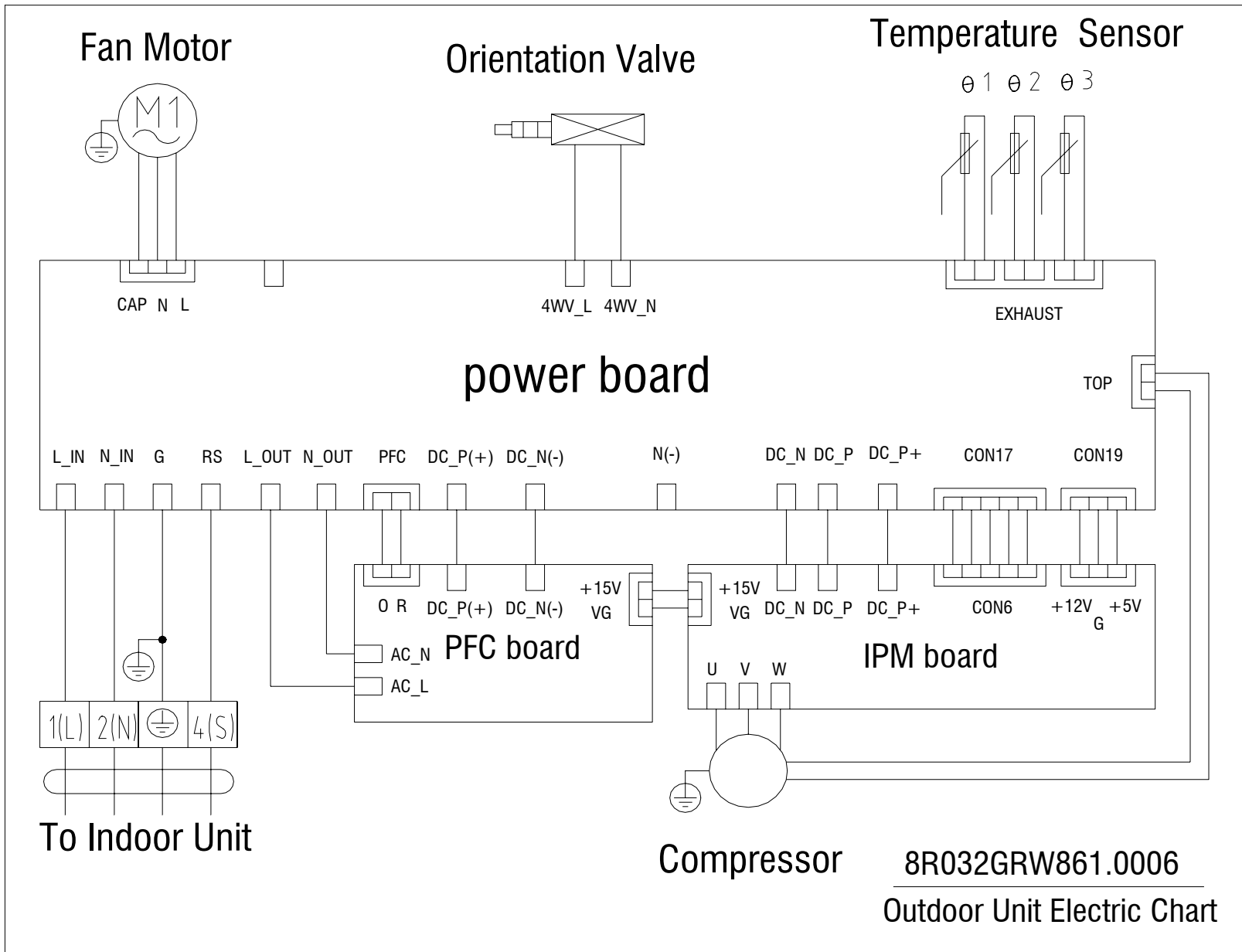

Operation Details

Main functions note

Remark: Tr: Tr means indoor environmental temperature
Te: Te means indoor temperature of evaporator
Ts: Ts means temperature setting
Tc: Tc means outdoor temperature of evaporator
Td: Td means discharge temperature of compressor
Ta: Ta means outdoor environmental temperature

1. Emergency mode

When it is shut down, the air conditioner will open and operate in automatic mode upon pressing the emergency mode, the default settings for the throttle is swing, and the default settings for wind speed is automatic wind; while it is open, it will shutdown automatic according to different modes upon pressing the emergency button.

2. Automatic mode

When choosing the automatic mode of the remote controller, the running lights flashing 20s, selected the running mode for system, the pattern determine the wind speed within 20s weak wind operation, the throttle put to refrigeration reference point, the compressor will controlled by fuzzy control pattern; The air conditioner automatically select cooling, dehumidification, heating mode in accordance with the indoor temperature.

1、 when $Tr \geq 26^{\circ}\text{C}$, choosing cooling mode and running according to cooling mode, temperature setting is 24°C .

2、 when $25^{\circ}\text{C} \leq Tr < 26^{\circ}\text{C}$, choosing cooling mode and running according to cooling mode, temperature setting is $Tr - 2^{\circ}\text{C}$.

3、 when $23^{\circ}\text{C} \leq Tr < 25^{\circ}\text{C}$, choosing dehumidification mode and running according to dehumidification mode, temperature setting is $Tr - 2^{\circ}\text{C}$

4、 when $Tr < 23^{\circ}\text{C}$, choosing heating mode and running according to heating mode, temperature setting is 26°C .

5、 The functions of this model are as follows: time setting, sleep, auto start, Anion, I feel and so on.

6、 After selecting the system mode, it won't change according to the indoor temperature in the circumstances of keeping

compressor not opened consecutive time < 2 hour; if the compressor not opened consecutive time $\geq 2\text{h}$, it will select the running mode again.

7、 Wind speed and the throttle determined by the remote controller.

8、 Opening it again after shut down, The air conditioner will select the running mode again.

3. Cooling mode

1、 Temperature setting is determined by the remote controller, the range of temperature is $16^{\circ}\text{C} \sim 32^{\circ}\text{C}$, temperature setting accuracy:

temperature $\pm 1^{\circ}\text{C}$, adjusting the temperature setting through the button of "temperature higher" and "temperature lower". Controller determine the running condition and speed of indoor fan through fuzzy control according to not only the gap between the current indoor temperature and temperature setting, but also the rate of change of temperature, in order to get the best running condition.

2、 Start frequency of compressor: 20HZ

3、 Movement rate of operating frequency: 1Hz/s

After start of compressor, it will operate stably at 60Hz $\geq 60\text{s}$.

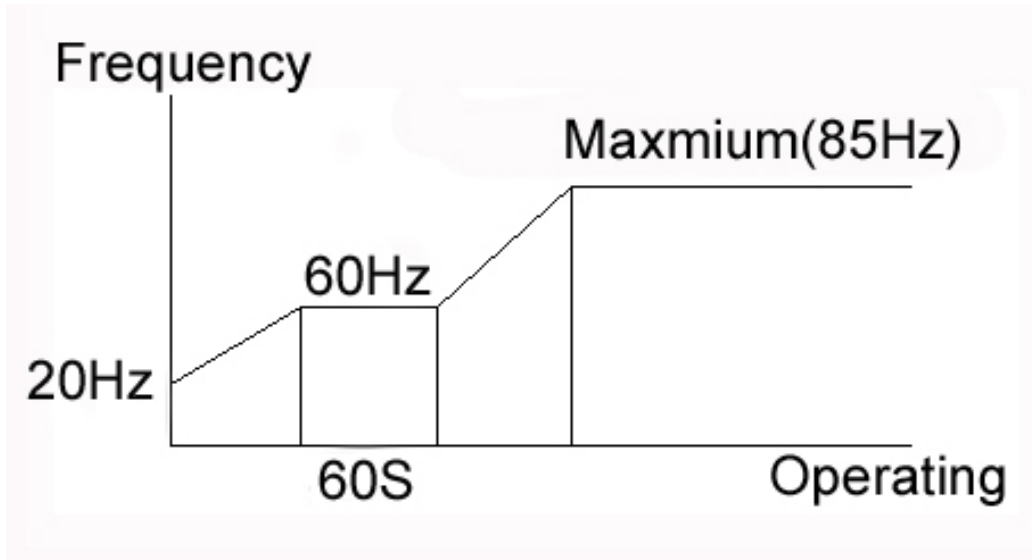

4、 output frequencies: $F = F_0 + \Delta F$

$\Delta F = K_p \times (E_{n+1} - E_n) + K_i \times E_{n+1} + K_d \times (E_{n+1} - 2E_n + E_{n-1})$

$F_0=20$, $K_p=6.0$, $K_i=8.0$, $K_d=2.0$ (EEPROM can adjust)

a .Frequency range: 20Hz~85Hz,if $F < 20\text{Hz}$, 20Hz is the bottom; if $F > 85\text{Hz}$, 85 Hz is the top.

b. $E_{n+1}=T_r-T_s$, E_{n+1} range: -3 ~+13

c. If consecutive time of $E_{n+1} \leq -2$ is 2min,the compressor will be shut down.

d. Starting with power, if $E_{n+1} \leq 0$,the compressor won't work, if $E_{n+1} > 0$,the compressor will open.

e. There are no temperature compensation for the firstly open, when the compressor start, it will be T_r temperature compensation, for example, compensate with 2°C , the $T_r=T_r(\text{true})+2^\circ\text{C}$.

f. when the compressor shut down, the indoor fan will still running according to the setting wind.

The above is the work frequency without any other restrictions on high-frequency and protections on down-frequency; if there are restrictions and protections, the frequency vale will adjust on the above value, and the adjust value according to the certain mode and the fault protection instructions.

5、 In cooling mode, it can set as automatic wind, high wind, medium wind, low wind to meet requirement, and the automatic wind speed can controlled as follows:

when $T_r \geq T_s + 3^\circ\text{C}$,High wind

when $T_s + 1^\circ\text{C} \leq T_r < T_s + 3^\circ\text{C}$,Medium wind

when $T_r < T_s + 1^\circ\text{C}$,low wind

At automatic speed, when the wind speed from low switching high, the wind speed without delay; while from high switching low, there will be delay with 3 min.

6、 The functions of this model are as follows: time setting, sleep, auto start, Anion, high efficiency

7、 According to cooling operation, there are anti-freeze protection of indoor coil , temperature thermal protection of outdoor exhaust, over-current protection, overheating protection of compressor, fault protection of indoor fan , sensor fault protection, fault protection of module, fault protection of communication, 3min delay protection of compressor.

8、 First start with power without 3 min delay protection.

9、 The order of on/off of Outdoor fan and compressor: The compressor will open 5s later after outdoor fan open and the outdoor fan will shut down 15s later after the compressor shut down.

10、 The restrictions and protection for T_a when cooling.

When $T_a \geq 47^\circ\text{C}$,it open as cooling mode normal, the maximum work frequency of

compressor:75HZ.

When $30^{\circ}\text{C} \leq T_a < 47^{\circ}\text{C}$, it open as cooling mode normal, the maximum work frequency of compressor:85Hz

When $16^{\circ}\text{C} \leq T_a < 30^{\circ}\text{C}$, it open as cooling mode normal, the maximum work frequency of compressor 65Hz

When $T_a < 16^{\circ}\text{C}$, the maximum work frequency of compressor 37Hz.

4. Dehumidification mode

1、Under dehumidification operation mode, if the setting temperature cannot adjust, the default setting temperature is 24°C ; if the setting temperature can adjust, it is subject to the setting temperature of the remote controller .

2、When $T_r > T_s + 2^{\circ}\text{C}$, the work mode as same as cooling mode, the speed according to the remote control.

When $T_s < T_r \leq T_s + 2^{\circ}\text{C}$, the frequency of compressor is as same as cooling mode, indoor fan running at low speed.

when $T_r \leq T_s$, the compressor work at 10mins (frequency:30Hz) stop 6 mins alternately, in this state, the open and shut down of compressor must meet 3 mins delay protection, the indoor fan work at low speed when the compressor work, while the compressor shutdown at the same time the indoor fan shut down.

when $T_r \leq 15^{\circ}\text{C}$, the compressor meets the work time ≥ 5 mins, the indoor fan as well as outdoor fan will stop.

3、The movement rate of frequency is 1Hz/s when it under dehumidification operation, and the operating frequency T_a will be restricted as cooling mode.

4、In dehumidification operational mode, it can set as automatically, high, medium, low wind, and the automatic wind speed can controlled as follows,

when $T_r \geq T_s + 5^{\circ}\text{C}$, high speed

when $T_s + 3^{\circ}\text{C} \leq T_r < T_s + 5^{\circ}\text{C}$, medium speed.

At automatic speed, when the wind speed from low switching high, the wind speed without delay; while from high switching low, there will be delay with 3 mins.

5、The functions of dehumidification are as follows: time setting, auto start, Anion, I feel.

6、The order of on/off of the outdoor fan, compressor are as same as cooling mode.

7、There are anti-freeze protection of evaporator under dehumidification operation mode.

5. Wind Mode

Outdoor unit keep closing at the wind mode and the indoor motor run at the certain wind speed .Remote Controller get 3 speed mode including high speed、middle speed and low speed without automatic wind.Working

Condition of air blade is as the same as cooling mode including timer、negative ion、I feel and auto restart.

6. Heating Mode

1、The certain temperature which fall within the range from $16^{\circ}\text{C} \sim 32^{\circ}\text{C}$ depend on Remote Controller, the

Temperature precision should be $\pm 1^{\circ}\text{C}$ and Controller box roughly adjust the working condition of compressor and the speed of indoor motor in order to achieve the best working condition according to the difference between indoor temperature & certain temperature and the change rate of indoor temperature.

2、Start frequency of compressor:20Hz;

3、Working frequency & up and down frequency

It should be 60Hz when compressor start, stable working condition ≥ 60 s;

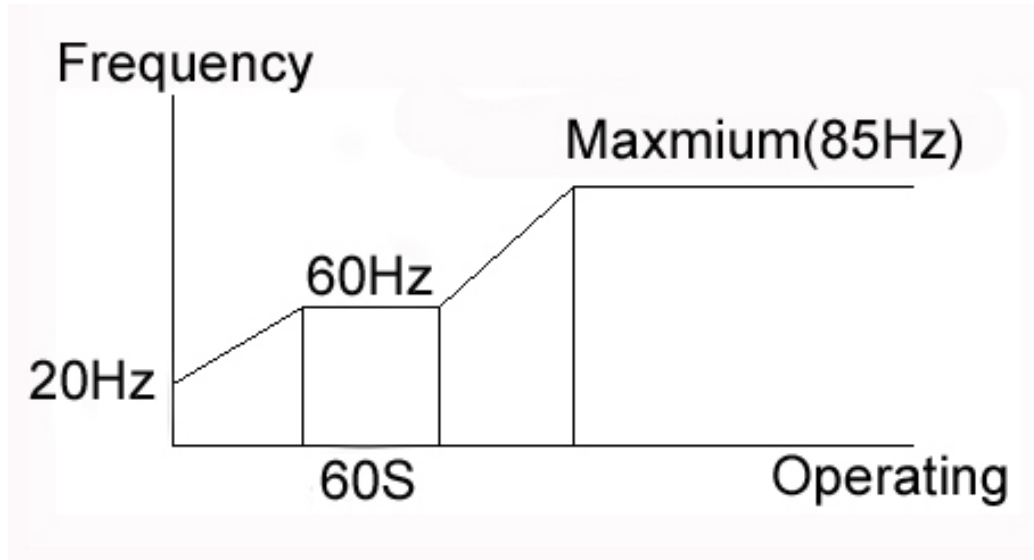

4、 Output frequency: $F = F_0 + \Delta F$

$$\Delta F = K_p \times (E_{n+1} - E_n) + K_i \times E_{n+1} + K_d \times (E_{n+1} - 2E_n + E_{n-1})$$

$F_0=20$, $K_p=6.0$, $K_i=8.0$, $K_d=2.0$ (EEPROM can adjust)

a. Frequency range: 20Hz~85Hz; If $F < 20\text{Hz}$, the less should be 20Hz; If $F > 85\text{Hz}$, the most should be 85Hz;

b. $E_{n+1}=T_s - T_r$, the range of E_{n+1} : $-3 \sim +13$;

c. If $E_{n+1} \leq -2$, it continue at 2 min and then shut down the compressor;

d. If $E_{n+1} < 0$ when it starts, compressor false to start. or compressor is able to start;

e. No temperature compensation at the first run and then go to the temperature compensation when compressor start, the compensation data in the EEPROM such as compensate 3°C and $T_r = T_r(\text{real dat}) - 3^\circ\text{C}$;

5、 Set auto、 high、 middle and low wind speed according to requirement at the heating mode, auto wind speed should be:

If $T_r \leq T_s - 5^\circ\text{C}$, it should be high wind speed;

If $T_s - 5^\circ\text{C} < T_r \leq T_s - 3^\circ\text{C}$, it should be middle wind speed;

If $T_r \geq T_s - 3^\circ\text{C}$, it should be low wind speed;

No delay for wind speed at the auto wind speed when change from low wind speed to high wind speed; or delay for 3 mins;

6、 Include timer、 sleep、 auto restart、 anti-cool、 auto anti-frost、 high efficiency running at the cooling mode; the button of air blade control the movement and stop of air blade;

7、 Include overheating protection of indoor pipe, overflowing protection, overheating protection of compressor, trouble protection of indoor motor, trouble protection of sensor, trouble protection of module, trouble protection of communication, 3min delay protection of compressor, specific information for the function indication of trouble protection ;

8、 For compressor No 3min delay protection at the first start;

9、 Flowing heat: indoor motor run at the lower wind speed when shut down by the remote controller or lash-up button and indoor air blade blow the leaving heat when compressor delay 15s to shut down. indoor motor and air blade will be shut down if $T_e < 40^\circ\text{C}$ when compressor's off;

10、 Four way valve and outdoor motor start when compressor run for 5s and outdoor motor will be shut down after compressor's off for 15s when it turn off or mode changes, four way valve start when compressor for 2min50s;

11、 Anti-cool

This function have priority to wind speed limitative function, specific operation as follows:

When compressor run: T_e at the upper trend

a)、 When $T_e < 25^\circ\text{C}$, indoor motor stop;

b)、 When $25^{\circ}\text{C} \leq T_e < 30^{\circ}\text{C}$, indoor motor run at the lower wind speed as soon as it operates. If T_e still at upper trend, it should be $T_e < 30^{\circ}\text{C}$ and indoor motor blow lower wind speed;

c)、 When $30^{\circ}\text{C} \leq T_e < 38^{\circ}\text{C}$, indoor motor run at the low wind speed;

d)、 When $T_e \geq 38^{\circ}\text{C}$, indoor motor run at the setting wind speed;

When T_e go down:

a)、 When $T_e \geq 34^{\circ}\text{C}$, indoor motor run at the setting wind speed;

b)、 When $28^{\circ}\text{C} \leq T_e < 34^{\circ}\text{C}$, indoor motor run at the low wind speed;

c)、 When $23^{\circ}\text{C} < T_e < 28^{\circ}\text{C}$, indoor motor run at the lower wind speed;

d)、 When $T_e \leq 23^{\circ}\text{C}$, indoor motor stop to run ;

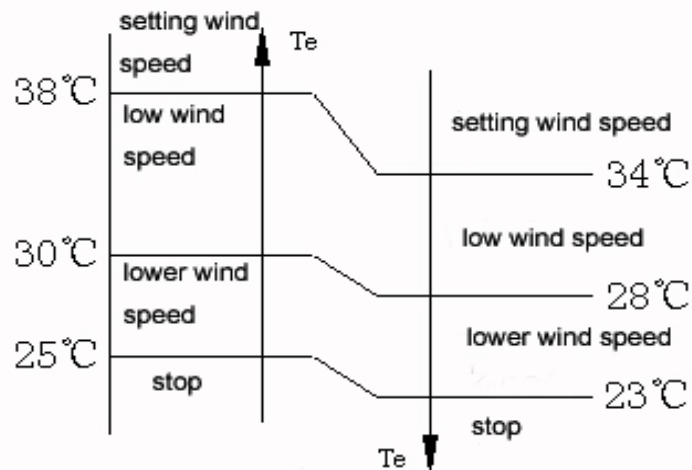

When compressor stop to run:

a)、 When T_e go down and $T_e > 25^{\circ}\text{C}$, indoor motor blow the lower wind speed; Or when $T_e \leq 25^{\circ}\text{C}$, indoor motor shut down;

b)、 When T_e go up and $T_e \geq 28^{\circ}\text{C}$, indoor motor blow the lower wind speed; Or when $T_e < 28^{\circ}\text{C}$, indoor motor shut down;

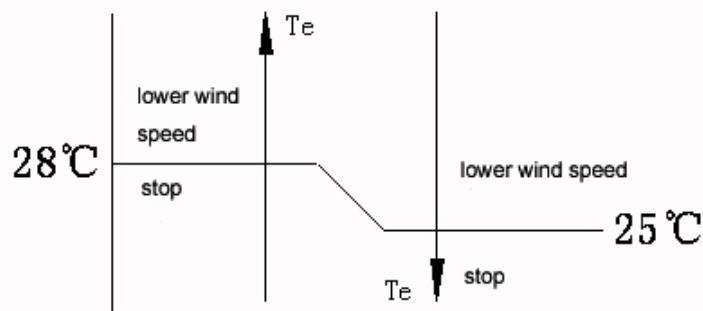

12、 Compare to protect the T_a (Indoor temperature) at the heating mode

When $T_a \geq 22^{\circ}\text{C}$, it's able to run at the heating mode and the highest working frequency of compressor is 50Hz;

When $22^{\circ}\text{C} > T_a \geq 10^{\circ}\text{C}$, it's able to run at the heating mode and the the highest working frequency of compressor is 70Hz;

When $T_a < 10^{\circ}\text{C}$, it's able to run at the heating mode and the the highest working frequency of compressor is 80Hz;

13、 Intelligent anti-frost

1、 Condition for anti-frost:

When the outdoor sensor's at the good condition and meet the following condition, it start to function:

1) When compressor run over 45min, mode change or shut down and the cumulate time

recalculate when compressor run continually over 5min;

2)Through test the temperature of sensor of Tc & Ta and meet the following condition at the consecutive 5min:

$$T_c \leq C \times T_a - \alpha$$

And C: $T_a < 0^\circ\text{C}$, $C=0.8$

$T_a \geq 0^\circ\text{C}$, $C=0.3$

$T_a \geq 0^\circ\text{C}$, $C=0.3$

Should be H when it's easy to frost,L when it's hard to frost,M when it's done.

The restrictment of temperature for anti-frost:

When the data is only $C \times T_a - \alpha \leq 2^\circ\text{C}$,it's able to take the frost away.

2、Anti-frost run

1)The compressor & outdoor motor stop to run after anti-frost start and four way valve stop to run after 50s;

2)It should be 60Hz for 60s when compressor run again and then run to 85Hz(EEPROM can adjust);

3)If overflow & exhaust of compressor are available and compressor stop to run as the protection of current when frost,compressor stop to run for 3min;If compressor stop to run for 10s because of other protection,compressor stop to run for 10s;If it's still at the time of anti-frost,it goes on and compressor run as per the rule of compressor operation;

4)Should the time of compressor operation be over 2min,it can quit from anti-frost.

3、Condition of anti-frost exit

Anti-frost quit automaticly if meet one of the following condition:

1)Temperature of outdoor heat exchanger $\geq 13^\circ\text{C}$ at the consecutive 80s

2)The consecutive time of anti-frost $\geq 9\text{min}$ (EEPROM can adjust)

4、Anti-frost exit

Compressor stop to run and outdoor motor start when compressor stop to run for 50s and then compressor's

7. Sleep Control

Sleep function is available at the auto、cooling、heating mode and indoor motor run at the lower wind speed at the sleep mode,indicator light work when working frequency meet the wind speed limitative frequency.

If press to the button of sleep to run for 1h,the certain temperature go up 1°C automaticly at the cooling mode ; If press to the button of sleep to run for 1h,the certain temperature go down 2°C automaticly.After run for 1h,the certain temperature go up 1°C again at the cooling mode and the certain temperature go down 2°C again at the heating mode.At last sleep function shut down after running for 7h.

If press the button to increase the temperature,air-conditioner keep running according to the new certain temperature+revised temperature at the sleep mode.

Cancel or shut down the sleep function if press the button of sleep、mode or off at the sleep mode.The highest frequency should be 54Hz and indoor motor blow the low wind speed at the cooling & sleep mode.

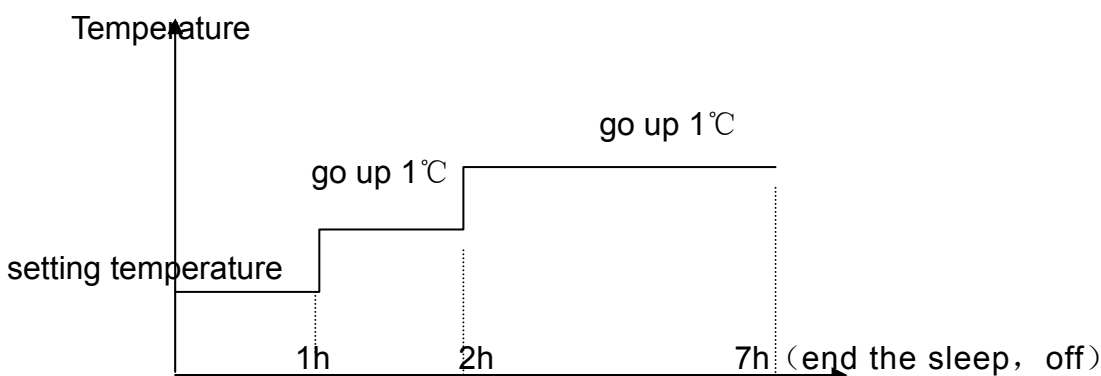

The highest frequency should be 60Hz and indoor motor blow the low wind speed at the heating & sleep mode.

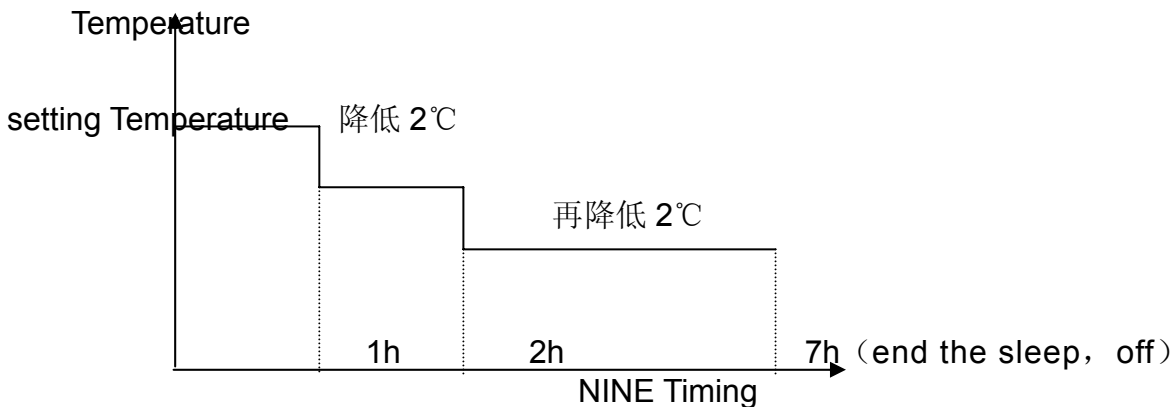

The highest timing should be 24h, 1min as unit, can't cancel timing at the single timing and no change to mode and indicator light run when timing has been made.

1、Timing for being off

Can only work the timing function which fall within the range from 1min to 24h when air-conditioner run and then will shut down when the timing is over.

2、Timing for being on

Can only work the timing function which fall within the range from 1min to 24h when air-conditioner shut down and then will run when the timing is over.

The former timing and sleep functions will be canceled automatically when you intend to run or shut down after timing.

8. Test Yourself

1、Test yourself procedure of indoor unit

Force to run and get to the test yourself procedure when buzzer ring for 2 short times → Digital pipe and 3 indicator lights work → Digital pipe display respectively "11"、"22"、"33"、"44" for 1s → Light run for 1s → Timing run for 1s → Sleep light run for 1s → Step motor run for 1s → indoor motor run for 1s at its full wind speed → Buzzer ring for 1 short time → Air-conditioner go to sleep and end test yourself procedure.

2、Test yourself procedure of outdoor unit

Force to run (CN6 get through outdoor electrical board), get to the test yourself procedure → test EEPROM → test temperature sensor → test communication of indoor and outdoor units → test communication between module and outdoor unit → test each output → air-conditioner go to sleep and end test yourself procedure.

9. The Protection Function Of Fault Instruction

1、The over-current protection:

total current $\geq 9A$	the compressor stops;
$8A \leq \text{total current} < 9A$	the compressor reduce operating frequency, if the current is still more than 8A when the frequency is down to 35 Hz, then the compressor will stop to work;
$7A \leq \text{total current} < 8A$	in this area the compressor prohibit from increasing the frequency;
The overall current $< 7A$	in this area the compressor operate normally

2、Anti-freeze protection of indoor coil while cooling and dehumidification

Te decline:

if $5^\circ C < T_e < 9^\circ C$, the compressor frequency remains unchanged if $T_e \leq 5^\circ C$, the frequency of the compressor will decline in the rate of 1Hz/10s

Te rise:

if $7\text{ }^{\circ}\text{C} \leq T_e < 11\text{ }^{\circ}\text{C}$, the frequency of the compressor will increase in the rate of 1Hz/10s
 frequency
 if $6\text{ }^{\circ}\text{C} \leq T_e < 7\text{ }^{\circ}\text{C}$, the compressor frequency remains unchanged;
 if $0\text{ }^{\circ}\text{C} < T_e < 6\text{ }^{\circ}\text{C}$, the frequency of the compressor will decline in the rate of 1Hz/10s
 if $T_e \leq 0\text{ }^{\circ}\text{C}$, and it goes on for more than 2 min, then the compressors and outdoor fans will stop working, but the indoor fan and the wind door will still operate normally in a weak speed .
 When the compressor stop running over 3 min, and $T_e \geq 11\text{ }^{\circ}\text{C}$, the compressor resume normal operation;

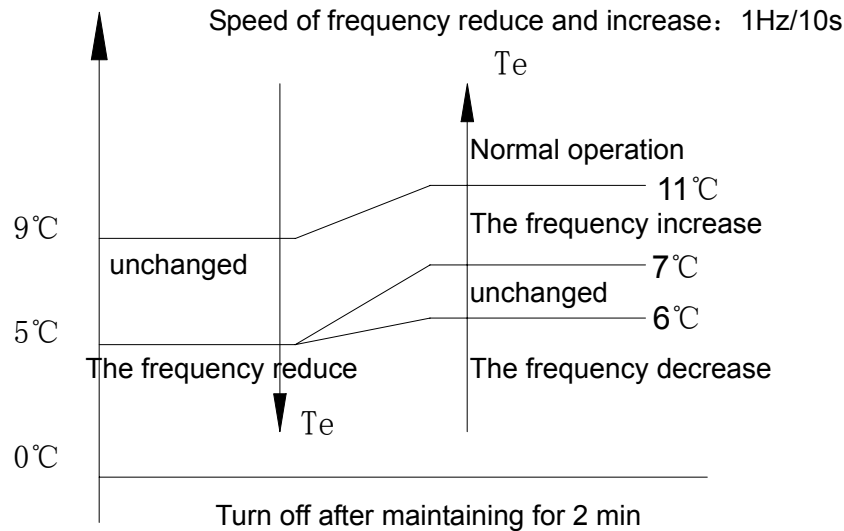

3. The overheating protection of indoor coil while heating

T_e rise:

if $T_e \geq 65\text{ }^{\circ}\text{C}$, and it goes on for more than 5 s, then it will stop working

if $56\text{ }^{\circ}\text{C} \leq T_e < 65\text{ }^{\circ}\text{C}$, the frequency of the compressor will decline in the rate of 1Hz/3s.

T_e decline:

if $52\text{ }^{\circ}\text{C} < T_e \leq 55\text{ }^{\circ}\text{C}$, the compressor frequency remains unchanged

if $48\text{ }^{\circ}\text{C} < T_e \leq 52\text{ }^{\circ}\text{C}$, the frequency of the compressor will increase in the rate of 1Hz/30s.

When the compressor stop running over 3 min, and $T_e \leq 48\text{ }^{\circ}\text{C}$, the compressor will resume normal operation;

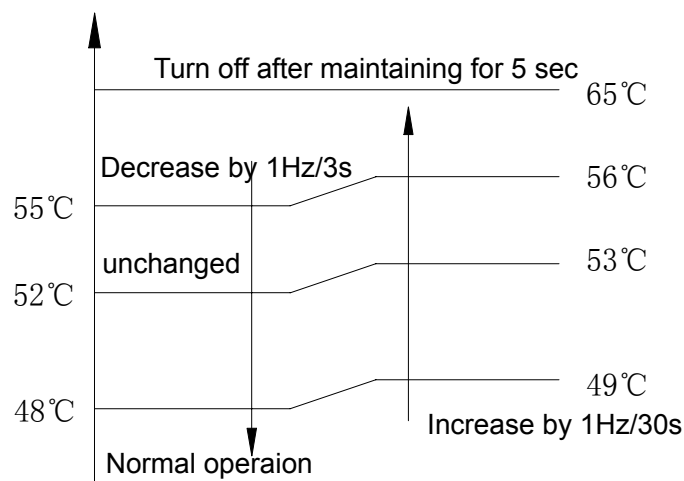

4. The overheating protection of compressor 5 min after the compressor starts to work,

If $85\text{ }^{\circ}\text{C} \leq T_d < 90\text{ }^{\circ}\text{C}$, the frequency of the compressor will increase in the rate of 1Hz/30s.

If $90\text{ }^{\circ}\text{C} \leq T_d < 95\text{ }^{\circ}\text{C}$, the compressor frequency remains unchanged;

If $T_d \geq 95\text{ }^{\circ}\text{C}$, the frequency of the compressor will decline in the rate of 1Hz/3s.

If $T_d \geq 110\text{ }^{\circ}\text{C}$, the compressor will stops immediately .

The above protection will go on until $T_d \leq 85^\circ\text{C}$, and it stops working more than 3 min, then the compressor will resume normal operation;

When the compressor restart again, if T_d reaches more than 110°C again within 15 min, the compressor will stop immediately and display the corresponding fault code.

5、 The malfunction protection of indoor fan-motor

If there is no signal after the indoor fan-motor starts working for 10 s, the indoor fan-motor will stop for 30 s. And this will test for three times consecutively within 10 s, if there is still no feedback signal (such as the fan is blocked or damaged, the wiring is disconnected, etc.), then the digital tube will display the corresponding fault code, furthermore the complete machine will stop working and can not be activated.

6、 The malfunction protection of the sensor

When the indoor and outdoor temperature sensor has the short circuit or the opening, it will display the corresponding fault code and the complete machine will stop working. It will resume to work until the fault code vanishes.

7、 Protection of IPDU module

When IPDU breaks down any of the following: exceeding the maximum rotational speed, vibration from the position, speed up abnormally, the G-TR short circuit, abnormal position detection of loop, abnormal current sensor, locking of the compressor, damage of the compressor, when the Case thermo moves, the compressor stops operating, and the outdoor unit will display the fault code while the indoor unit will show the total fault code, and the compressor will re-start again after 3 min. If such failures happen consecutively for two times within 4 min, there will be permanent shutdown and the power must be cut off if you want to re-activate.

8、 Fault communication protection

If the air-conditioner is not in normal communications in continuous 90s, it will show the corresponding fault code, then the compressor will stop after 30s. Until it is in normal communications and the fault code disappears, the air-conditioner will activate automatically if it meets the protection conditions for 3 min.

9、 System Fault Protection

1. the cooling mode:

If it is measured $T_r - T_e < 5^\circ\text{C}$ (for different sensor models, the error was 2°C) after the compressor continually operates for 5 min, the indoor fan will operate in weak wind automatically. If still $T_r - T_e < 5^\circ\text{C}$

8 min later, then the compressor stops and displays the fault code. The electricity must be cut off and re-power in order to restart.

2. the heating mode:

A) If $T_e < 20^\circ\text{C}$ continues for 20 min, then it stops working and displays the fault code. The electricity must be cut off and re-power in order to restart work.

We judge from system failures by this condition only within 20 min after we turn-on the machine, 20 min later we no longer judge by this condition. If remote control, emergency switch is turned off or the electricity is cut off suddenly, we re-judge system failure after the air conditioner restart again within 20 min.

B) in the normal operation of the compressor, if $T_e < 5^\circ\text{C}$ continues for 5 min, then it stops and display the corresponding code. The electricity must be cut off and re-power in order to restart work.

Judging from system failures in the following conditions: only 20 min after turn-on the machine and also the compressor must have run for more than 5 min.

10、 Fault protection of zero detection

There will be small 100 Hz AC voltage when indoor AC voltage pass by full-wave rectifier, and the CPU will detect the zero point of this voltage to control the speed of indoor fan. If such zero point can not be detected for 400 ms, then it will display the fault code, the complete machine will stop working and can not be started.

11、Compressor delay protection

The start of the compressor will be delayed for 3 min if the outdoor unit is in a charged state, and if it is in a non-charged state, the outdoor compressor will start without delay. There is no such delay protection within 3 min for the first power-on.

12、Alert function of sound and light

1. There is a buzzer in the controller. When receiving instructions from the remote controller, the buzzer will call for one time; when the power is on, it will call for two times; when the remote controller is turned on or off, it will call for one time longer.

2. The LED digital tube will display the fault code in case of failure

13、Display function

1. Indoor display

2. Display run operation state through three LED lights:

Operation	Green	The running light will turn on when start.
Timer	Yellow	The timer light will turn on if the machine is in the course of timer.
Sleeping	Red	The sleeping light will turn on when the air conditioner set sleep function during running.

Working status display as follows:

Timer	Operation	Sleep	Marks description: O means lights on ★ means lights flash × means lights off – means arbitrary
Operation Status			
O	O	-	normal operation, regular shutdown
O	×	×	regular turn-on
-	O	-	normal operation
×	×	×	malfunction
-	O	O	means go to sleep
-	-	★	means at that stage of defrosting

3. Fault display

A, The three LED lights will be off and the digital tube will display the fault code if there is any failure.

B, If there is any other fault after solving this troubleshooting, it will continue to diagnosis and display until the fault disappears.

Fault protection display as follows:

Digital display of the indoor malfunction

Fault code	Name of the troubleshooting
E1	fault of indoor environment temperature sensor
E2	fault of 100Hz zero detection
E3	fault of indoor evaporator temperature sensor
E4	fault of the indoor fan
E5	fault of the indoor EEPROM
E6,	communication failures of the indoor and outdoor unit
E7	system failures (including cooling and heating)

Digital display of the outdoor malfunction

Fault code	Name of the troubleshooting
F1	fault of the outdoor temperature sensor
F2	fault of the outdoor condenser temperature sensor
F3	fault of the compressor discharge temperature sensor
F4	protection from excessive exhaust temperature
F5	fault of the outdoor EEPROM
F6	fault of IPDU Module

4. Display status for faults lights of outdoor board, refer to the table for display status lights

LED2 shining times possible reasons for faults

- (1).outdoor temperature sensor abnormal
- (2).outdoor defrosting sensor abnormal
- (3).compressor venting temperature abnormal
- (4).compressor venting temperature too high
- (5).outdoor communication abnormal'
- (6).communicating with IPDU module abnormally
- (7).E²PROM data abnormal
- (8).IPDU abnormal; exceeding max turning value
- (9).IPDU abnormal; shaking
- (10).IPDU abnormal; off position
- (11).IPDU abnormal; accelerating abnormal
- (12).IPDU abnormal; G-TR short circuit
- (13).IPDU abnormal; position checking returning abnormal
- (14).IPDU abnormal; electricity sensing abnormal
- (15).IPDU abnormal; compressor locked
- (16).IPDU abnormal; compressor damaged

10. Wind Door Waving Angle Definition

(diagram 1) 48G(excluding 48G) below is waving angle for electrical machine of E series hanging air conditioner

1、 when connected to electricity wind door will appear to full closing, waving speed is 22°/s
2、 After turned on, wind door will full open first, then wave to the original position accordingly, when heating , it stops at (diagram 1) position 5, while refrigerating, it will return to (diagram 1) position 2.

3、 wind door button on the remote control can be set to be free waving hand waving.

4、 when free waving, waving scope for heating is 50°, such as (diagram 1) between 3 and 5, waving scope for refrigerating is 50°, (diagram 1) between 2 and 4, waving speed is 5.5°/s

5、 when connected to electricity, and remote control does not set wind door to wave, the waving angle will move to the position according to different models and fix position, for example,,(diagram 1) position 2 is refrigerating model, (diagram 1) position 5 is heating model, after 风机 starting up, wind door will recover to free waving; while remote control set wind door as hand waving, the waving angle will not change all the time.

6、 wind door will close automatically, after being turned off and indoor motor stops working

7、 pressing enforcing starting button to go into the automatical model, after system choose the model and start to work, wind door will open, and before this, wind door stops at refrigerating base position.

8、 when being connected to electricity and model exchanging, wind swing will reset to the direction of closing one time, when resetting indoor motor stops.

9、 when heating is breeze, wind door is forced to horizontal position wind door waving angle for new production style E

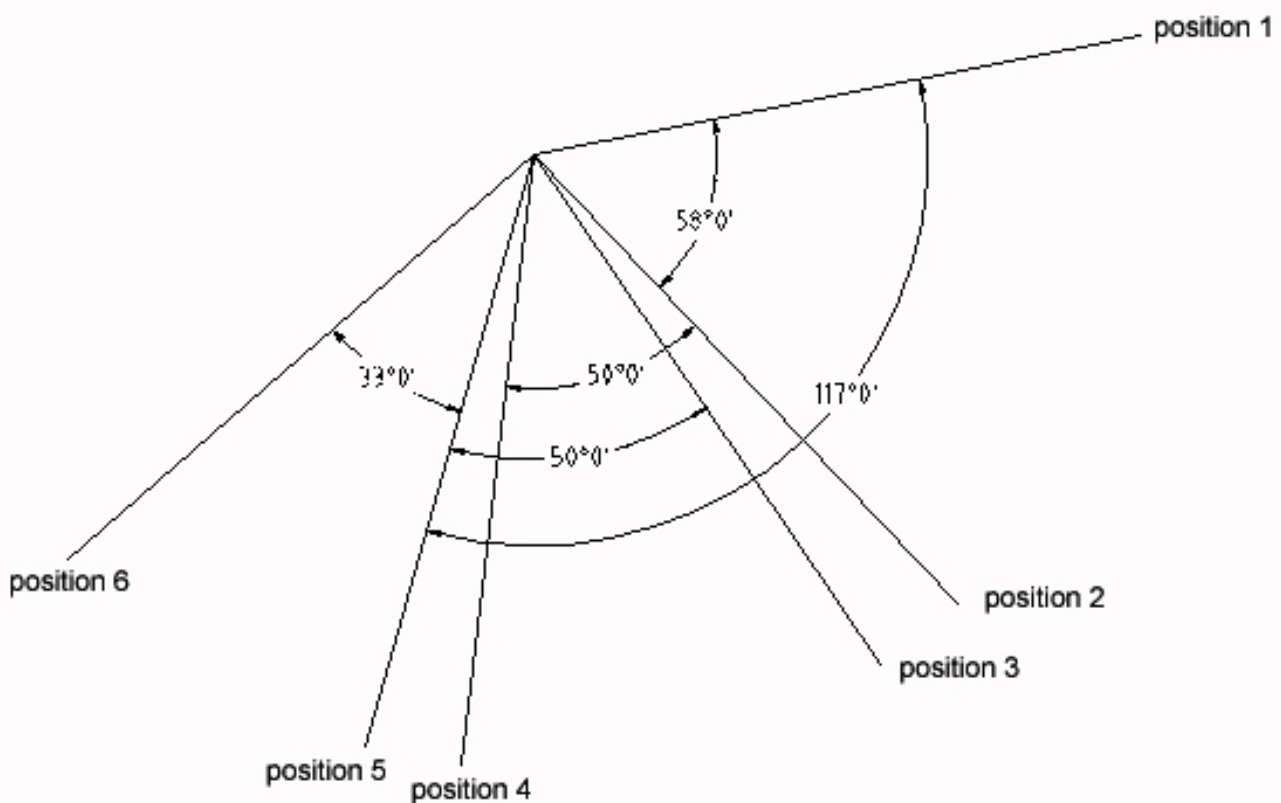

Position 6, (full opening) position 5 (heating base point) position 4(refrigerating waving end) position 3(heating waving end) position 2 (refrigerating base point) position 1 (full closing)

11. Wind Speed Choosing Function

When running normally, wind speed will work as normal controlling speed for every model.

Unit; r/min

Wind speed button	high wind	middle wind	low wind	breeze
Refrigerating speed	1080	1000	920 (frequency<= 50Hz)	650
Heating speed	1080	1000	920 (frequency<= 60Hz)	650

12. "Black-Out Mode Function"

1、 Setting method: controller "black-out mode function" setting method is that after controller is connected to electricity, press the sleeping button ten times within 8s with remote control towards controller, if this function is set successfully, buzzer will make sound four times. If want to cancel this memory function , operate as before, press the sleeping button ten times within 8s with remote control towards controller,, if buzzer sounds twice, canceling is ok, if no sound for buzzer , it fail to cancel.

2、 Content for memory function: running model, setting wind speed, Ts, waving status and turning on /turning off status.

3、 If"black-out mode function" is set successfully, power is missing after turning off normally, then connect it to electricity and turn on, compressor will have no 3min extending protection, if stop power when turning on, then 3min extending protection will works after reconnect power and turn on .

4、 After"black-out mode function" is ok, If sleeping function or timing function are set before power is missing, then status for controller will acquiesce turning off status after reconnecting to electricity

13. Negative Ion Function

In case that indoor motor starts up, press the Negative ion function button on the remote control, then negative ion electrical apparatus on the controller open, the whole machine will

output negative ion; In case that Negative ion function is started, press the Negative ion function button on the remote control, negative ion electrical apparatus on the controller close, the whole machine will not output negative ion

14. "I Feel" Function

1. Enter method

press "I Feel" function button on the remote control, when controller receives signal, then enter "I Feel" function, at this time, controller will treat the temperature for sensor on the remote control as Tr on the original controller to deal (including the time of intelligent defrost) temperature compensation is still effective, frequency will still be counted as according formula.

2. Remote control towards the receiving window for controller, remote control will lunches a signal every 3min after "I Feel" function starts up.

3. When "I Feel" function is starting up, main control board will not check the original Tr sensor on controller.

4. Quitting methods

a) press "I Feel" function button one more time, this function will be cancelled.

b) If controller can not receive the signal for remote control within 10min, "I Feel" function will be cancelled automatically, Tr will re-control as the temperature that Tr sensor on controller checks

15. Testing under Rated Work

1. Refrigerating rated testing

high wind and temperature 18 C are set, receive signal for sleeping button 8 times continuously within 8s, if refrigerating rated testing function is set successfully, buzzer will sound four times, system enter rated testing status, compressor will run as fixed frequency 54Hz, if any one condition above does not work, rated frequency running will quit.

2. Heating rated testing

high wind and temperature 30 C are set, receive signal for sleeping button 8 times continuously within 8s, if refrigerating rated testing function is set successfully, buzzer will sound four times, system enter rated testing status, compressor will run as fixed frequency 60Hz, if any one condition above does not work, rated frequency running will quit.

16. The Lowest Frequency Testing

1. Refrigerating rated testing refrigerating rated testing

high wind and temperature 18 C are set, receive signal for sleeping button 12 times continuously within 8s, if refrigerating rated testing function is set successfully, buzzer will sound four times, system enter the lowest frequency testing status, compressor will run as the lowest frequency 30Hz, if any one condition above does not work, the lowest frequency testing running will quit.

2. Heating rated testing

high wind and temperature 30 C are set, receive signal for sleeping button 12 times continuously within 8s, if refrigerating rated testing function is set successfully, buzzer will sound four times, system enter the lowest frequency testing status, compressor will run as the lowest frequency 30Hz, if any one condition above does not work, the lowest frequency testing running will quit.

17. High Efficiency Running

High efficiency running only suits for two models: refrigerating and heating.

1. Main control board receives high efficiency on remote control and enters high efficiency

Refrigerating: frequency 85Hz, wind speed too high (1130r/min) Heating: frequency 85Hz, wind speed too high (1130r/min), preventing cold wind function is still effective

2. time >15min high efficiency stops



3. all limiting and protecting terms work during the time of high efficiency

- 4、 if quit high efficiency running automatically, run as the status that's set previous of refrigerating and heating high efficiency running, when remote control quit, run as the status that adjuster set..
- 5、 When there is protecting, there will be no excessive high wind, if frequency doesn't reach 80Hz, excessive high wind is not allowed.

Disassembly Of The Parts

Attention: Turn off the air-conditioner and pull out the plug of the power supply before the service.

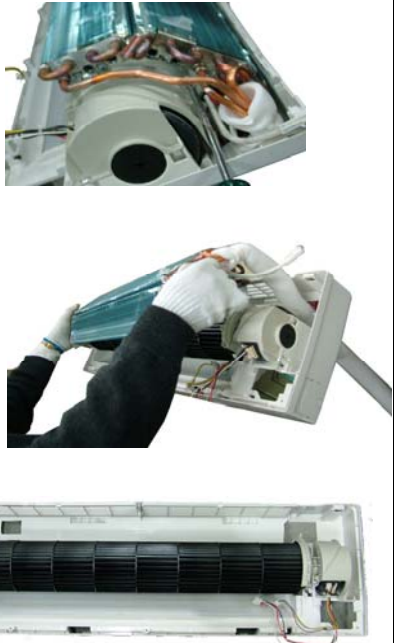
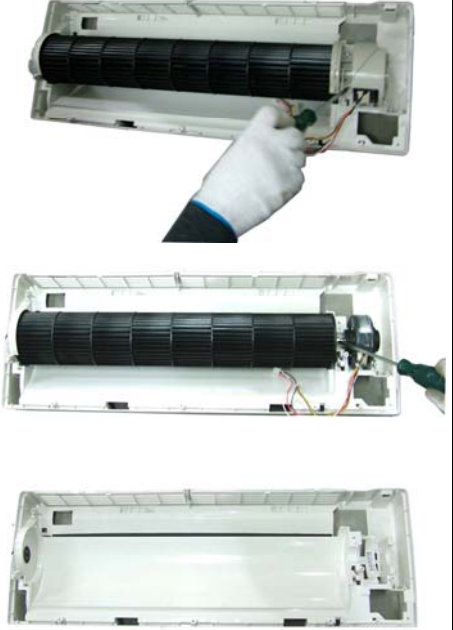

1. Indoor unit:

No.	Part	Operation Process	Remark
1	Panel	<p>1) Turn off the air-conditioner and cut off the power supply; 2) Tear the adhesive tape sticking to the panel;</p> <p>3) Hold the handles at both sides of the panel and push upward to have it slip out; 4) Grasp the both sides of the panel and push upward; 5) Turn the upper board by 90° and unload it from the connecting pole carefully;</p> <p>6) Take out the filter from the right and left side.</p> <p>7) Screw off the bolts on the electrical box cover and unload the box cover;</p> <p>8) Screw off the 5 bolts (for 1Hp AC) or 8 bolts (for 1.5Hp AC) on the medium frame; 9) Hold the both sides of the medium frame and open it gently 10) Turn up the medium frame by about 90°; 11) Offload the medium frame once hearing the crack sound;</p>	
2	Electrical component	<p>1) Do No."1" and "2" firstly, offload the water drainage soft tube; 2) Offload the water draining tank from chassis and take out the electrical components.</p>	
3	Water draining tank	<p>1) Do No. "1" firstly; 2) Pull out all tie-in connecting with PCB and the temperature sensor, etc.; 3) Screw off the screws and bolts as indicated in the picture. Untie the</p>	

		<p>outdoor unit's interconnection cord and power supply cord from the terminal of the electrical box.</p> <p>4) If the main PCB board is loosed by chance, remove it away;</p>	
4	Evaporator	<p>1) Do No."1" , "2" and "3" firstly;</p> <p>2) Offload the connecting pipe;</p> <p>3) Offload the tube clip at the rear;</p> <p>4) Screw off the bolts at the right and left side;</p> <p>5) Lift up the evaporator, and draw it out from the indoor unit;</p>	
5	Indoor fan Fan motor	<p>1) Screw off one bolt from the motor cover, and remove the motor cover;</p> <p>2) Offload the motor from the fan;</p> <p>3) Offload the fan from bearing;</p>	

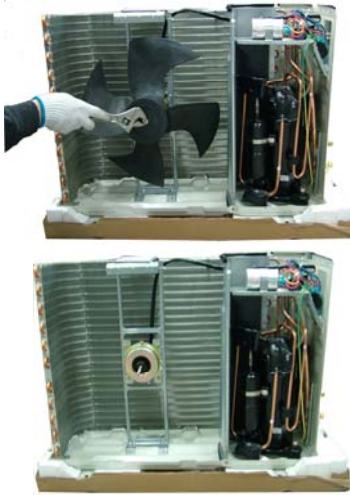
2. Outdoor unit:

No.	Part	Operation Process	Remark
1	General operation	<p>1) Screw off one fastening bolt from the electrical box cover, and offload the box cover;</p> <p>2) Pull out the interconnection cord from the electrical box;</p> <p>3) Screw off the five fastening bolts from the cover board, and offload the board; Screw the six fastening bolts from the front panel, and offload the front panel;</p> <p>4) Screw off the fastening bolts from the electrical assembly;</p> <p>5) Screw off the eight fastening bolts and offload the outer frame;</p>	
2	Outdoor fan motor	<p>1) Do No. "1" firstly;</p> <p>2) Screw off the fastenings screws clockwise.</p> <p>3) Offload the fan.</p> <p>4) Screw off the four fastening bolts and offload the fan motor;</p> <p>5) Screw off the two fastening bolts and offload the fan motor bracket.</p>	

3	Condenser	<ol style="list-style-type: none"> 1) Do No."1" and "2" firstly; 2) Screw off the two fastening bolts; 3) Weld off the inlet and outlet tube; 4) Offload the condenser. 	
4	Compressor	<ol style="list-style-type: none"> 1) Do No."1" , "2"and "3" firstly; 2) Open the cover of compressor, release the connection cord. 3) Weld off the inlet and outlet tube; 4) Screw off the three screws; 5) Offload the compressor. 	

Exploded Pictures

(1) Indoor unit exploded picture (ASW-H09A4/SAR1DI)

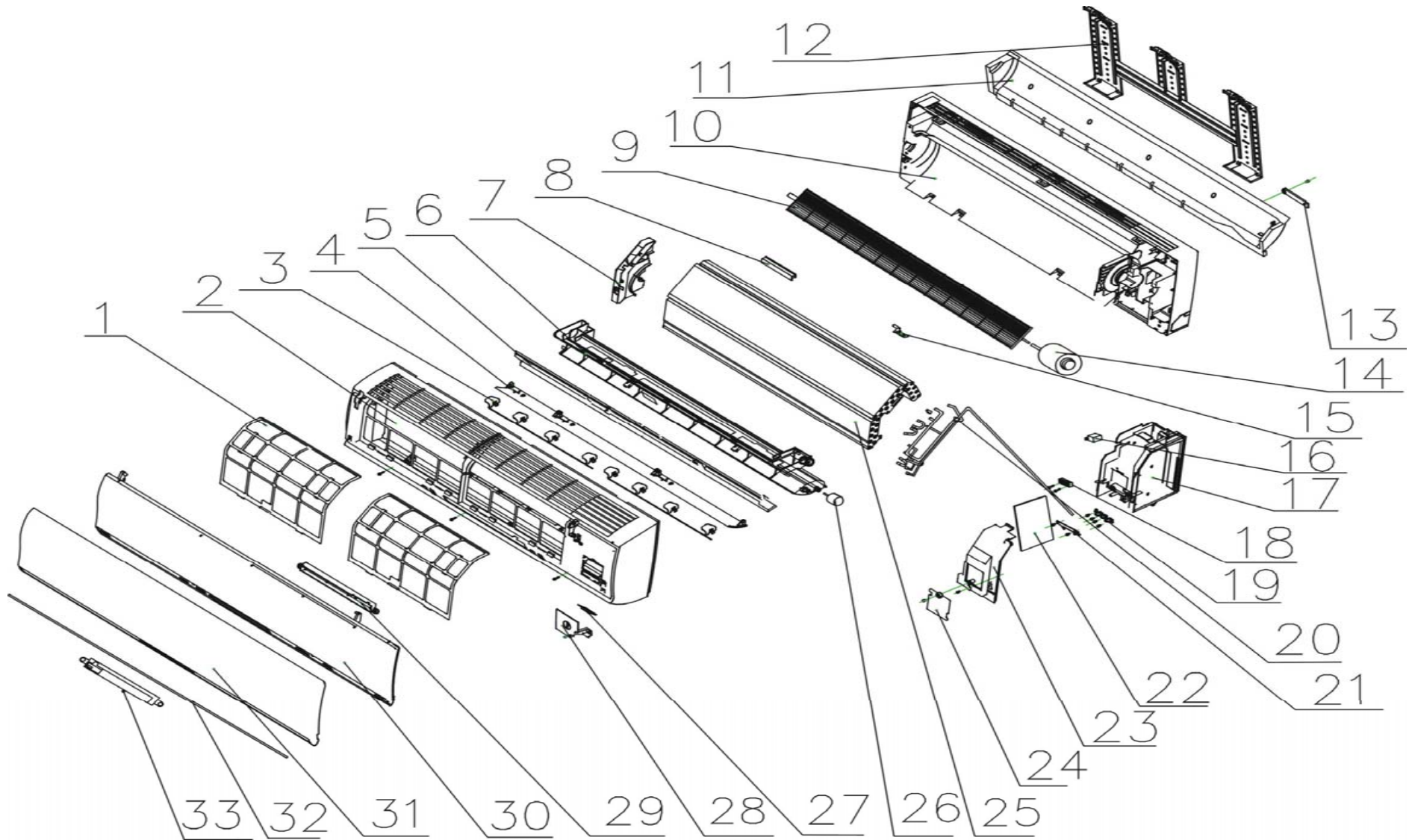

PARTS LIST OF INDOOR UNIT EXPLODED PICTURE (ASW-H09A4/SAR1DI)

No.	Chinese Name	Name	Qua.
1	过滤网	Filter	2
2	中框	Medium frame	1
3	导风叶片	Vertical air-blade	8
4	导风门	Horizontal air-blade	1
5	导风架泡沫	Foam of air blade holder	1
6	导风架	Air-vent holder	1
7	蒸发器支架	Left plastic-crutch for evaporator	1
8	底座盖板	Cover of chassis	2
9	贯流风叶	Through-flow fan	1
10	底座	Chassis	1
11	底座泡沫	Chassis foam	1
12	挂板	Mounting plate	1
13	管路压攀	Pipe clamp	1
14	塑封电机	Indoor fan motor	1
15	滑块	Slip block	3
16	变压器	Transformer	1
17	电控盒	Electric controller box	1
18	端子板	Terminal board	1
19	压线板	Wire clamp	1
20	蒸发器配管	Evaporator tubing assembly	1
21	遥控器接收座	Signal receiver holder for remote controller	1
22	主控板	Main PCB	1
23	电控盒上盖	Cover of electric controller box	1
24	接线盖	Top cover of electric controller box	1
25	蒸发器	Evaporator	1
26	步进电机	Step motor	1
27	接受窗	Receiver window for remote controller	1
28	电控盒盖	Cover of medium frame	1
29	显示灯座	Indication lamp holder	1
30	面板衬板	Panel scaleboard	1
31	面板	Panel	1
32	镜面装饰板	Panel ornamental board	1
33	显示灯板	Display board	1

(2) Outdoor unit exploded picture (ASW-H09A4/SAR1DI)

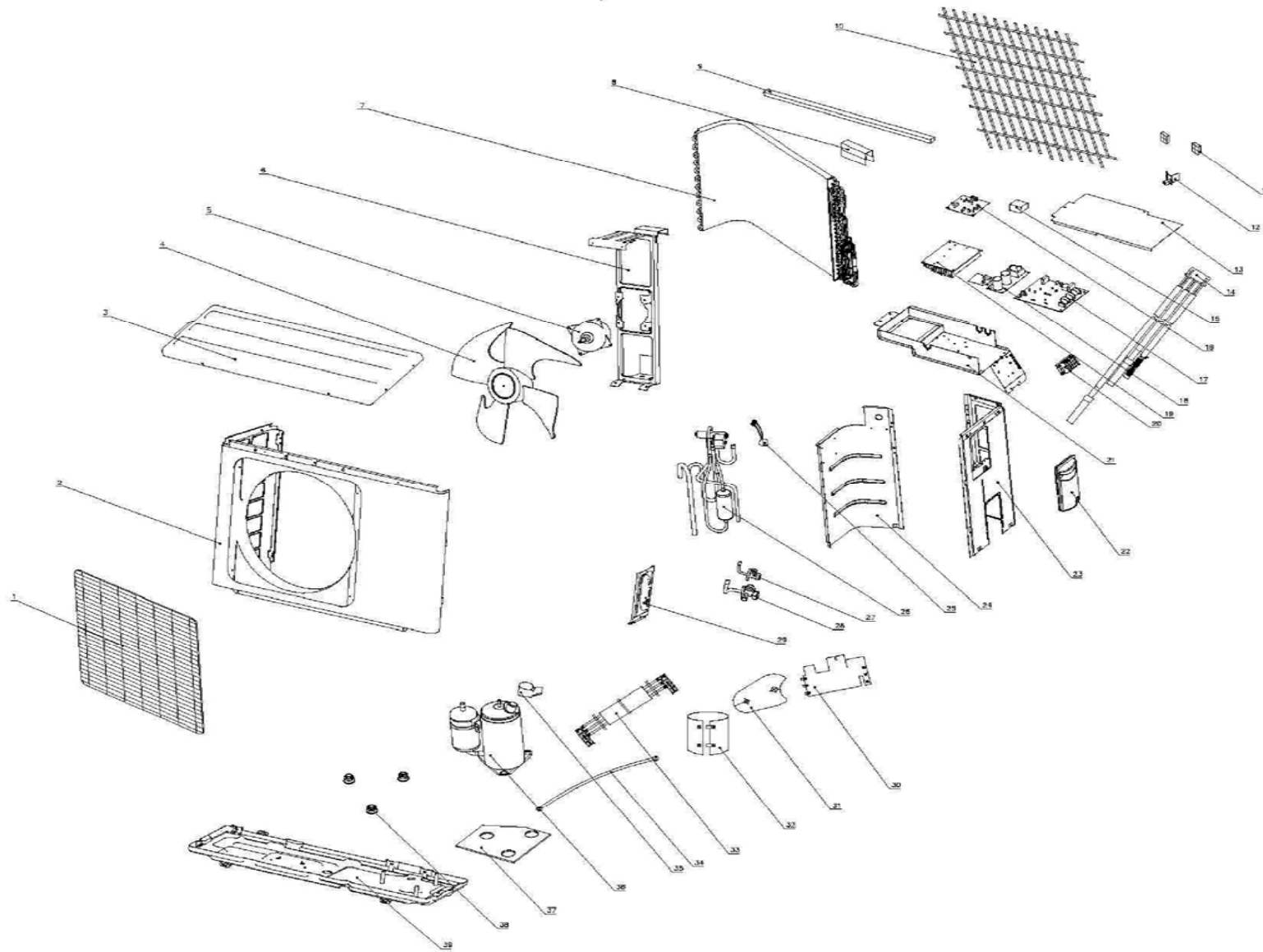

PARTS LIST OF OUTDOOR UNIT EXPLODED PICTURE (ASW-H09A4/SAR1DI)

No.	Chinese Name	Name	Qua.
1	面板网罩	Panel net	1
2	面板组件	Panel	1
3	顶盖板	Top cover board	1
4	轴流风扇	Axial-flow fan	1
5	风扇电机	Fan motor	1
6	电机支架	Motor bracket	1
7	冷凝器总成	Condenser assembly	1
8	冷凝器夹块	Condenser clamp	1
9	冷凝器海绵	Condenser sponge	1
10	背部钢丝网罩	Back steel net	1
11	隔离橡胶块	Partition rubber block	2
12	温控探头固定座	Fixed stand of temperature sensor	1
13	电器架盖板	Electric board cover	1
14	室外传感器	Outdoor temperature sensor	1
15	整流桥	Commutating element	1
16	PM 模块	PM module	1
17	电源控制主板	Main board	1
18	PFC 模块及电抗组件	PFC module and reactance element	1
19	散热片	Radiating fin	1
20	四位端子板	Four phase terminal board	1
21	电器架 A	Electric board A	1
22	电器盖板	Handle	1
23	右侧板	Right side plate	1
24	隔风立板组件	Partition panel	1
25	四通阀线圈	Four way valve circuit	1
26	四通阀管路组件	Four way valve assembly	1
27	截止阀组件 B	Liquid valve assembly	1
28	截止阀组件 A	Gas valve assembly	1
29	阀板	Valve panel	1
30	压缩机消音棉 A	Anti-acoustic sponge A of compressor	1
31	压缩机消音棉 B	Anti-acoustic sponge B of compressor	1
32	压缩机消音棉 C	Anti-acoustic sponge C of compressor	1
33	压缩机连接线	Connected line of compressor	1
34	压缩机接地线	Earth line of compressor	1
35	压缩机接线端子盖	Terminal cover of compressor	1
36	压缩机组件	Compressor	1
37	压缩机底部消音棉	Bottom anti-acoustic sponge of compressor	1
38	橡胶垫	Rubber cushion of compressor	3
39	底盘组件	Chassis assembly	1

(3) Indoor unit exploded picture (ASW-H12A4/SAR1DI)

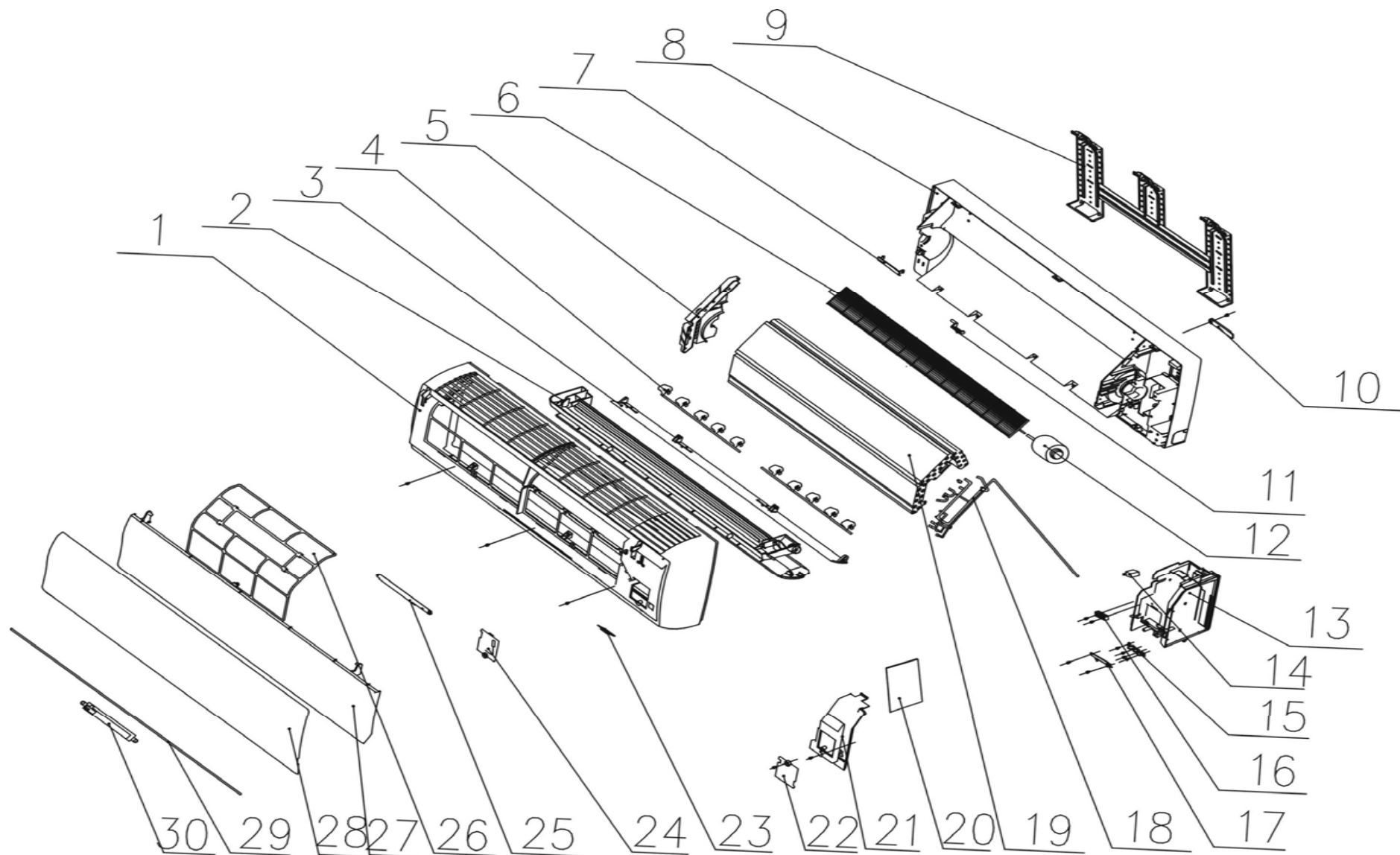

PARTS LIST OF INDOOR UNIT EXPLODED PICTURE (ASW-H12A4/SAR1DI)

No.	Chinese Name	Name	Qua.
1	中框	Medium frame	1
2	导风架	Air-vent holder	1
3	导风门	Horizontal air-blade	1
4	导风叶片	Vertical air-blade	10
5	蒸发器支架	Left plastic-crutch for evaporator	1
6	贯流风叶	Through-flow fan	1
7	底座盖板	Cover of chassis	2
8	底座	Chassis	1
9	挂板	Mounting plate	1
10	管路压攀	Pipe clamp	1
11	滑块	Slip block	3
12	塑封电机	Indoor fan motor	1
13	电控盒	Electric controller box	1
14	变压器	Transformer	1
15	压线板	Wire clamp	1
16	端子板	Terminal board	1
17	遥控器接收座	Signal receiver holder for remote controller	1
18	蒸发器配管	Evaporator tubing assembly	1
19	蒸发器	Evaporator	1
20	主控板	Main PCB	1
21	电控盒上盖	Cover of electric controller box	1
22	接线盖	Top cover of electric controller box	1
23	接收窗	Receiver window for remote controller	1
24	电控盒盖	Cover of medium frame	1
25	显示灯座	Indication lamp holder	1
26	过滤网	Filter	2
27	面板衬板	Panel scaleboard	1
28	面板	Panel	1
29	镜面装饰板	Panel ornamental	1
30	显示灯板	Display board	1

(2) Outdoor unit exploded picture (ASW-H12A4/SAR1DI)

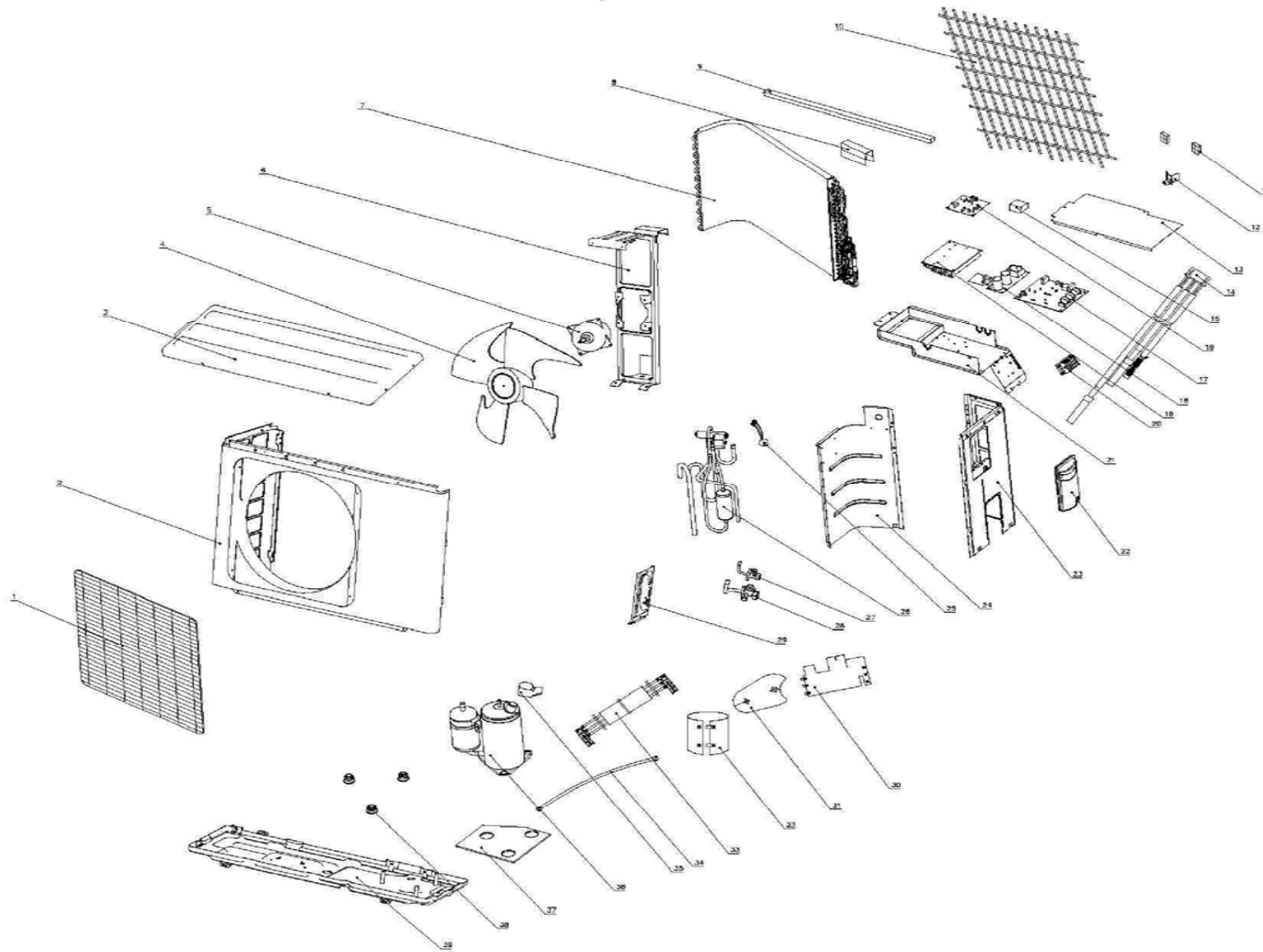

PARTS LIST OF OUTDOOR UNIT EXPLODED PICTURE (ASW-H12A4/SAR1DI)

No.	Chinese Name	Name	Qua.
1	面板网罩	Panel net	1
2	面板组件	Panel	1
3	顶盖板	Top cover board	1
4	轴流风扇	Axial-flow fan	1
5	风扇电机	Fan motor	1
6	电机支架	Motor bracket	1
7	冷凝器总成	Condenser assembly	1
8	冷凝器夹块	Condenser clamp	1
9	冷凝器海绵	Condenser sponge	1
10	背部钢丝网罩	Back steel net	1
11	隔离橡胶块	Partition rubber block	2
12	温控探头固定座	Fixed stand of temperature sensor	1
13	电器架盖板	Electric board cover	1
14	室外传感器	Outdoor temperature sensor	1
15	整流桥	Commutating element	1
16	PM 模块	PM module	1
17	电源控制主板	Main board	1
18	PFC 模块及电抗组件	PFC module and reactance element	1
19	散热片	Radiating fin	1
20	四位端子板	Four phase terminal board	1
21	电器架 A	Electric board A	1
22	电器盖板	Handle	1
23	右侧板	Right side plate	1
24	隔风立板组件	Partition panel	1
25	四通阀线圈	Four way valve circuit	1
26	四通阀管路组件	Four way valve assembly	1
27	截止阀组件 B	Liquid valve assembly	1
28	截止阀组件 A	Gas valve assembly	1
29	阀板	Valve panel	1
30	压缩机消音棉 A	Anti-acoustic sponge A of compressor	1
31	压缩机消音棉 B	Anti-acoustic sponge B of compressor	1
32	压缩机消音棉 C	Anti-acoustic sponge C of compressor	1
33	压缩机连接线	Connected line of compressor	1
34	压缩机接地线	Earth line of compressor	1
35	压缩机接线端子盖	Terminal cover of compressor	1
36	压缩机组件	Compressor	1
37	压缩机底部消音棉	Bottom anti-acoustic sponge of compressor	1
38	橡胶垫	Rubber cushion of compressor	3
39	底盘组件	Chassis assembly	1

AUX 宁波奥克斯空调有限公司

ADD:NO.1166 North MingGuang Road(AUX Technology Park),Jiang Shan Town,Ningbo,Zhejiang,P.R.China

TEL:86-574-88220826 FAX:86-574-88220720

Http://www.cnaux.com

E-mail:auxsales@mail.auxgroup.com